

LECTURE NO: 1

Objective:

In this lecture we will discuss “**software crisis**” in detail with reason behind this crisis. It will be followed by discussion on the classic model with reference to water fall model and V model, what are the drawbacks in this model and then need for an Agile process model

History of software crisis:

Software crisis was a term used in the early days of computing science. The term was used to describe the impact of rapid increases in computer power and the complexity of the problems which could be tackled. In essence, it refers to the difficulty of writing correct, understandable, and verifiable computer programs. The term "software crisis" was coined by F. L. Bauer at the first NATO Software Engineering Conference in 1968 at Garmisch, Germany

Software CHAOS Report Standish Group Study

In 1986, Alfred Spector, president of Transarc Corporation, co-authored a paper comparing bridge building to software development. The premise: Bridges are normally built on-time, on budget, and do not fall down. On the other hand, software never comes in on-time or on-budget. In addition, it always breaks down. (Nevertheless, bridge building did not always have such a stellar record. Many bridge building projects overshot their estimates, time frames, and some even fell down.).

One of the biggest reasons bridges come in on-time, on-budget and do not fall down is because of the **extreme detail of design**. The design is frozen and the contractor has little flexibility in changing the specifications. However, in today's fast moving business environment, a frozen design does not accommodate changes in the business practices. Therefore a more flexible model must be used. This could be and has been used as a rationale for development failure. But there is another difference between software failures and bridge failures, beside 3,000 years of experience. When a bridge falls down, it is investigated and a report is written on the cause of the failure. This is not so in the computer industry where failures are covered up, ignored, and/or rationalized. As a result, we keep making the same mistakes over and over again.

FAILURE RECORD

In the United States, we spend more than \$250 billion each year on IT application development of approximately 175,000 projects. The average cost of a development project for a large company is \$2,322,000; for a medium company, it is \$1,331,000; and for a small company, it is \$434,000. A great many of these projects will fail. Software development projects are in chaos, and we can no longer imitate the three monkeys -- **hear no failures, see no failures, speak no failures.**

The Standish Group research shows a staggering 31.1% of projects will be cancelled before they ever get completed. Further results indicate 52.7% of projects will cost 189% of their original estimates. The cost of these failures and overruns are just the tip of the proverbial iceberg. The lost opportunity costs are not measurable, but could easily be in the trillions of dollars. One just has to look to the City of Denver to realize the extent of this problem. The failure to produce reliable software to handle baggage at the new Denver airport is costing the city \$1.1 million per day. Based on this research, The Standish Group estimates that in 1995 American companies and government agencies will spend \$81 billion for cancelled software projects. These same organizations will pay an additional \$59 billion for software projects that will be completed, but will exceed their original time estimates. Risk is always a factor when pushing the technology envelope, but many of these projects were as ordinary as a drivers license database, a new accounting package, or an order entry system.

On the success side, the average is only 16.2% for software projects that are completed on time and on-budget. In the larger companies, the news is even worse: only 9% of their projects come in on-time and on-budget. And, even when these projects are completed, many are no more than a mere shadow of their original specification requirements. Projects completed by the largest American companies have only approximately 42% of the originally-proposed features and functions. Smaller companies do much better. A total of 78.4% of their software projects will get deployed with at least 74.2% of their original features and functions.

This data may seem disheartening, and in fact, 48% of the IT executives in our research sample feel that there are more failures currently than just five years ago. The good news is that over 50% feel there are fewer or the same number of failures today than there were five and ten years ago.

Reasons for Failure:

- i. Unclear, unstable, misunderstood and missing requirements
- ii. To late integration of results of working and components, thus to late recognition of risks and errors
- iii. Fast changing technologies
- iv. Missing Quality Management
- v. Overvaluation of documents
- vi. No model-based process

Examples of Software Failures:

First Known Software Bug:

Buggy Computer Club, in 1945 engineers found a moth in Panel F, Relay #70 of the Harvard Mark II system. The computer was running a test of its multiplier and adder when the engineers noticed something was wrong. The moth was trapped, removed and taped into the computer's logbook with the words: "**first actual case of a software bug being found.**"

i. NASA: Mariner Failure in 1962

A bug in the flight software for the Mariner 1 causes the rocket to divert from its intended path on launch. Mission control destroys the rocket over the Atlantic Ocean. The investigation into the accident discovers that a formula written on paper in pencil was improperly transcribed into computer code, causing the computer to miscalculate the rocket's trajectory.

ii. Korean Airliner Crash

The Korean Airlines KAL 801 accident in Guam killed 225 out of 254 aboard. A software design problem was discovered in barometric altimetry in Ground Proximity Warning System (GPWS)

iii. Customer Tracking System

In 1996 a San Francisco bank was poised to roll out an application for tracking customer calls. Reports provided by the new system would be going directly to the president of the bank and board of directors. An initial product demo seemed sluggish, but telephone banking division managers were assured by the designers that all was well. But the system crashed constantly, could not support multiple users at once and did not meet the bank's security requirements. After three months the project was killed; resulting in a loss of approximately \$200,000 in staff time and consulting fees.

Problems:

- i. The bank failed to check the quality of its contractors
- ii. Complicated reporting structure with no clear chain of command
- iii. Nobody "owned" the software

iv. Pay Roll System Failure:

The night before the launch of a new payroll system in a major US health-care organization, project managers hit problems. During a sample run, the off-the-shelf package began producing cheques for negative amounts, for sums larger than the top executive's annual take-home pay, *etc.* Payroll was delivered on time for most employees but the incident damaged the relationship between information systems and the payroll and finance departments, and the programming manager resigned in disgrace.

Problems:

- i. The new system had not been tested under realistic conditions
- ii. Differences between old and new systems had not been explained (so \$8.0 per hour was entered as \$800 per hour)
- iii. "A lack of clear leadership was a problem from the beginning"

Critical Failure Factors:

Critical reason for failures as discussed in some of the major examples above are as follow:

- i. Organization: hostile culture, poor reporting structures
- ii. Management: over-commitment, political pressures
- iii. Conduct of the project:
 - a. Initiation phase: technology focused, lure of leading edge, complexity underestimated

- b. Analysis and design phase: poor consultation, design by committee, technical fix for management problem, poor procurement
- c. Development phase: Staff turnover, poor competency, poor communication (e.g. split sites)
- d. Implementation phase: receding deadlines, inadequate testing, inadequate user training.

Software Process – An Overview

“Software Processes model models desired phases or activities in the project”

Water Fall Model:

The *waterfall model* is a model for software development (a process for the creation of software), which develop regularly flowing downwards (like a waterfall). The development runs through a number of phases, namely: definition study / analysis, basic design, technical design / detailed design, construction, testing, integration, management and maintenance. Previously, a large software development, especially large cluttered knitting. With the advent of this new method, the computer companies hoped to clarify in their projects. The waterfall model is derived from the traditional way of working in large construction projects in construction. The purpose of this way of working is that divides the project into phases. You start with phase 1 and phase 2 to begin no earlier than when you have completed Phase 1. And when you're in a phase of an error you must do to correct back to that stage and the subsequent steps again.

History of Water Fall Model:

On the origin of the term “waterfall” is often said that Winston Royce introduced it in 1970, but Royce saw them more in the repeated approach to software development and even used the term “waterfall”. Royce described the waterfall model as a method he ventured even an invitation to failure occurred. In 1970 Royce was that the waterfall model should be seen as the first draft, he felt that the method has flaws. He brought a document which examined how the initial concept to a recurrent method could be developed; this new model in each phase was between a feedback to the previous stage, as we now see in many current methods. Royce was just annoying for the initial focus method, the criticism he had on this method was largely ignored. Despite Royce's intentions to the waterfall model into a repeat method (iterative model), the use of this method is still very popular, but opponents of the waterfall model see it as a naive and inappropriate method for use in the real world “.

Phases of Water Fall Model

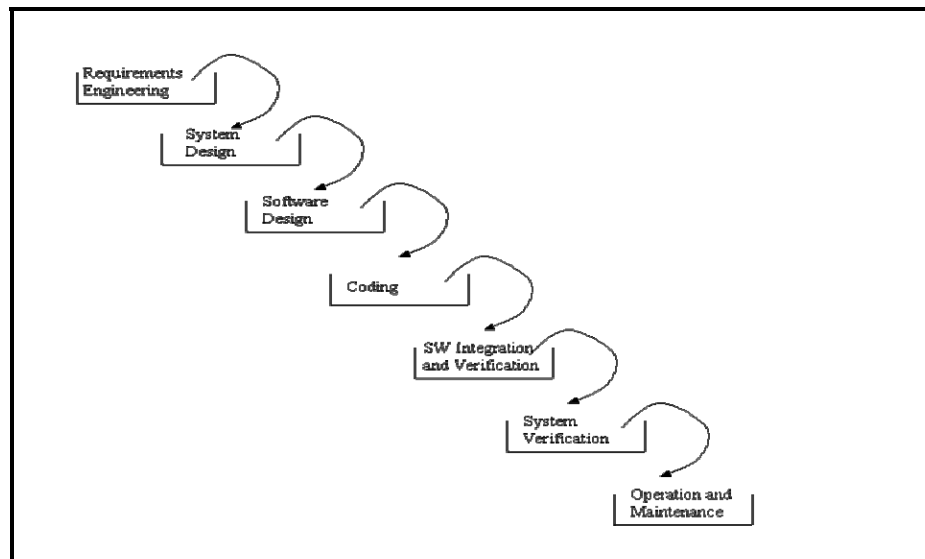

Requirement Analysis & Definition:

All requirements of the system which has to be developed are collected in this step. Like in other process models requirements are split up in functional requirements and constraints which the system has to fulfill. Requirements have to be collected by analyzing the needs of the end user(s) and checking them for validity and the possibility to implement them. The aim is to generate a Requirements Specification Document which is used as an input for the next phase of the model.

System Design:

The system has to be properly designed before any implementation is started. This involves an architectural design which defines and describes the main blocks and components of the system, their interfaces and interactions. By this the needed hardware is defined and the software is split up in its components. E.g. this involves the definition or selection of a computer platform, an operating system, other peripheral hardware, etc. The software components have to be defined to meet the end user requirements and to meet the need of possible scalability of the system. The aim of this phase is to generate a System Architecture Document this serves as an input for the software design phase of the development, but also as an input for hardware design or selection activities. Usually in this phase various documents are generated, one for each discipline, so that the software usually will receive a software architecture document.

Software Design:

Based on the system architecture which defines the main software blocks the software design will break them further down into code modules. The interfaces and interactions of the modules are described, as well as their functional contents. All necessary system states like startup, shutdown, error conditions and diagnostic modes have to be considered and the activity and behavior of the software has to be defined. The output of this phase is a Software Design Document which is the base of the following implementation work.

Coding:

Based on the software design document the work is aiming to set up the defined modules or units and actual coding is started. The system is first developed in smaller portions called units. They are able to stand alone from an functional aspect and are integrated later on to form the complete software package.

Software Integration & Verification:

Each unit is developed independently and can be tested for its functionality. This is the so called Unit Testing. It simply verifies if the modules or units to check if they meet their specifications. This involves functional tests at the interfaces of the modules, but also more detailed tests which consider the inner structure of the software modules. During integration the units which are developed and tested for their functionalities are brought together. The modules are integrated into a complete system and tested to check if all modules cooperate as expected.

System Verification:

After successfully integration including the related tests the complete system has to be tested against its initial requirements. This will include the original hardware and environment, whereas the previous integration and testing phase may still be performed in a different environment or on a test bench.

Operation & Maintenance:

The system is handed over to the customer and will be used the first time by him. Naturally the customer will check if his requirements were implemented as expected but he will also validate if the correct requirements have been set up in the beginning. In case there are changes necessary it

has to be fixed to make the system usable or to make it comply to the customer wishes. In most of the "Waterfall Model" descriptions this phase is extended to a never ending phase of **"Operations & Maintenance"**. All the problems which did not arise during the previous phases will be solved in this last phase.

Advantages

If in the beginning of the project failures are detected, it takes less effort (and therefore time and money) for this error. In the waterfall model phases are properly sealed first before proceeding to the next stage. It is believed that the phases are correct before proceeding to the next phase. In the waterfall model laid down the emphasis on documentation. In the newer software development methodologies makes it less documentation. This means that when new people come in the project, and people leave it is difficult to transfer knowledge. This disadvantage is not the traditional waterfall model. It is a straightforward method. The way of working ensures that there are specific phases. This tells you what stage it is. One can use this method of milestones. Milestones can be used to monitor the progress of the project to estimate. The waterfall model is well known. Many people have experienced, so there might be easy to work. When frequent portions of the software product to be delivered this gives the customer confidence, but also the software development team.

Disadvantages

There are some disadvantages of this way to develop software. Many software projects are dependent on external factors. The client is a very important external factor. Often the requirements over the course of the project change, because the client wants something different. It is a disadvantage that the waterfall model assumes that the requirements will not change during the project. When a requirement changes in the construction phase, a substantial number of phases made again. It is very difficult to time and cost estimate. The phases are very large, it is therefore very difficult to estimate how much each step cost. In a number of new methods are almost all aspects of a software development process included. One can think of planning techniques, project management methods and how the project should be organized. For example: the designers and builders. They all have a different view of the project as designers look at the project differently than the builder and conversely, the builders often look different from the design of the designers look than the designers themselves.

Frequently, the design will be adjusted again. Here is the waterfall model is not made for that. Within the project the team members often specialized. One team member will be only the

first phase involved the design, while the only builders in construction helping to build the project. This can lead to waste of different sources. **The main source is the time.**

An example:

Assume the software designers are working on perfecting the design. The programmers are in principle already started building, but because they work with the waterfall model, they should wait until the first phase is complete. This is a typical example of wasted time. Testing is done only in one of the last phases of the project. In other software development methods will be tested once a certain part and finished product is at last an integration test. Due to so much emphasis on documentation, the waterfall model is not efficient for smaller projects. There's too much effort to the project itself around in terms of documentation.

V-Model – An Extension of Water Fall Model:

Keeping in view of the disadvantages of Water Fall model, a refined version of Water Fall model is developed which is known as “**V-Model**”. If we look at it closely the individual steps (in the diagram below) of the process are almost the same as in the waterfall model. Therefore we will not describe the individual steps again, because the description of the waterfall steps may substitute this. However, there is on big difference. Instead of going down the waterfall in a linear way the process steps are bent upwards at the coding phase, to form the typical V shape. The reason for this is that for each of the design phases it was found that there is a counterpart in the testing phases which correlate to each other.

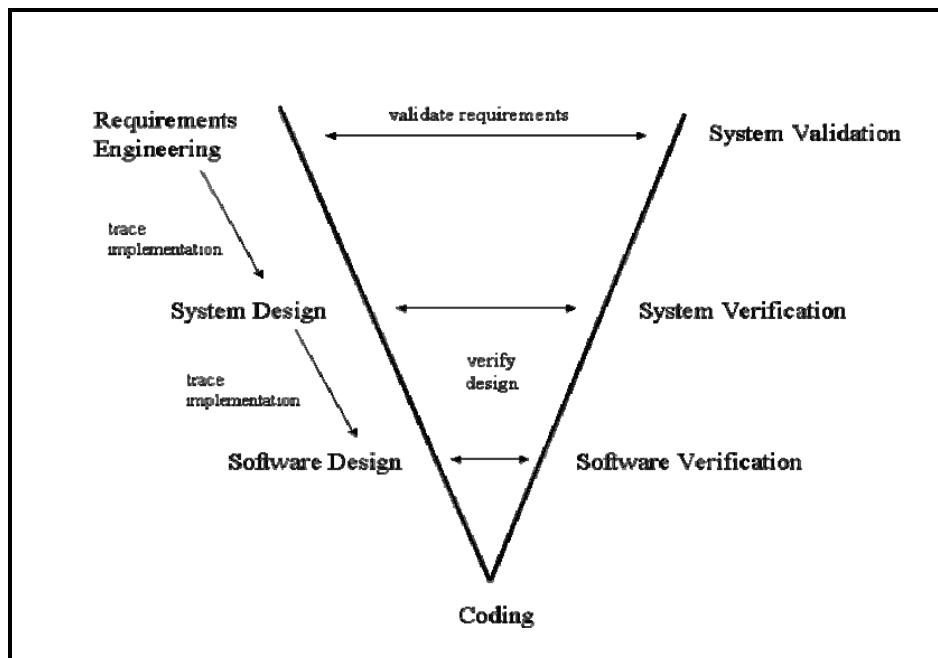

The time in which the V-model evolved was also the time in which software testing techniques were defined and various kinds of testing were clearly separated from each other. This new emphasis on software testing (of course along with improvements and new techniques in requirements engineering and design) led to the evolution of the waterfall model into the V-model. The tests are derived directly from their design or requirements counterparts. This made it possible to verify each of the design steps individually due to this correlation. Another idea evolved which was the **traceability** down the left side of the V. This means that the requirements have to be traced into the design of the system, thus verifying that they are implemented completely and correctly. Another feature can be observed when you compare the waterfall model to the V-model. The "Operation & Maintenance" phase was replaced in later

versions of the V-model with the validation of requirements. This means that not only the correct implementation of requirements has to be checked but also if the requirements are correct. In case there is the need of an update of the requirements and subsequently the design and coding, etc. there are two options. Either this has to be treated like in the waterfall model in a never ending maintenance phase, or in going over to another V-cycle. The earlier versions of V-models used the first option. For later versions a series of subsequent V-cycles was defined, as shown below:

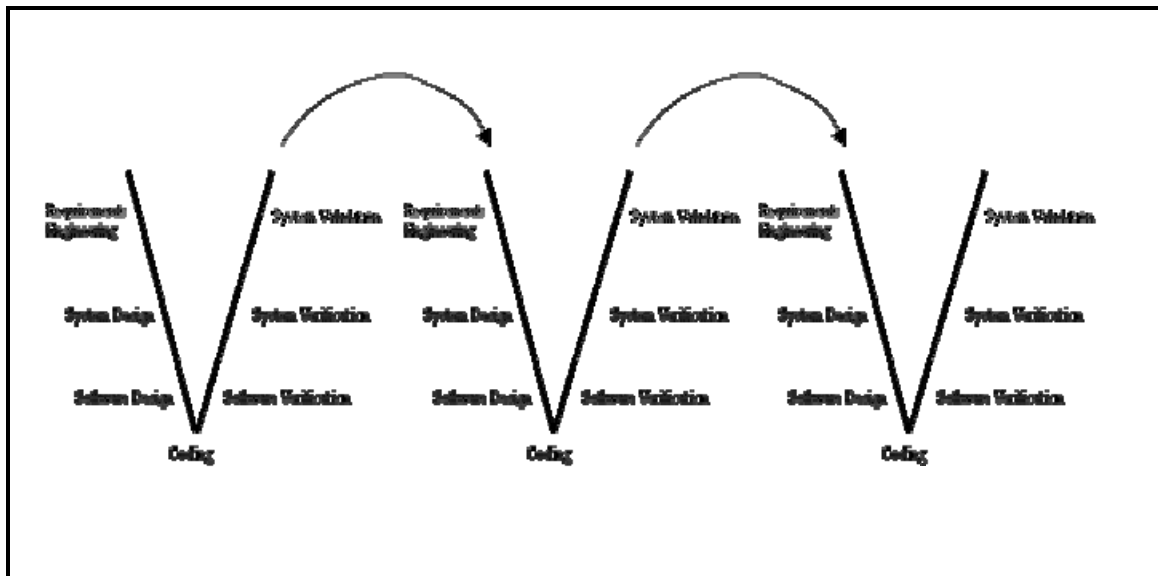

This idea also correlated with the established sample phases for products as it is present in many industries. One of the cascaded V-cycles became the V-cycle of a sample phase. In addition to this the V-cycles were tailored. This means that in earlier sample phases not all the intermediate work products and process step were established in their full beauty but it was simply reduced to what makes sense. By these measures the V-model became a usable process model. It does not consider every detail and possibility but evaluated over a multitude of projects in various industries it proved its usability.

LECTURE NO: 2

Objective:

This lecture will provide in depth knowledge of agile software processes and we will discuss Extreme Programming – An agile software processes in detail.

Standish Report in 2006:

- Studied **40,000** projects in 10 years
- That's more than a 100-percent improvement from the success rate in **1995**
- The primary reason is the projects have gotten a lot smaller. Doing projects with iterative processing as opposed to the **waterfall method**, which called for all project requirements to be defined up front, is a major step forward

Agile Processes:

Slogan: “Change is the only constant”

Software development can be equated to any other engineering task. We believe software development projects can be effectively managed by:

Understanding and writing specifications that define how the software will look and what it will do. We need to perform in-depth analysis and design work before estimating development costs. We should ensure software developers follow the specifications and then testing the software after implementation to make sure it works as specified, and Delivering the finished result to the user that is, if the specification is of sufficient detail, then the software will be written such that it will satisfy the customer, will be within budget, and will be delivered on time.

One of the most important differences between the agile and waterfall approaches is that waterfall features distinct phases with checkpoints and deliverables at each phase, while agile methods have iterations rather than phases. The output of each iteration is a working code that can be used

to evaluate and respond to changing and evolving user requirements. Waterfall assumes that it is possible to have perfect understanding of the requirements from the start. But in software development, stakeholders often don't know what they want and can't articulate their requirements. With waterfall, development rarely delivers what the customer wants even if it is what the customer asked for.

Agile methodologies embrace iterations. Small teams work together with stakeholders to define quick prototypes, proof of concepts (**POC**), or other visual means to describe the problem to be solved. The team defines the requirements for the iteration, develops the code, and defines and runs integrated test scripts, and the users verify the results. Verification occurs much earlier in the development process than it would with waterfall, allowing stakeholders to fine-tune requirements while they're still relatively easy to change. In agile processes we use a term **“Release”** which actually reflect a working and executable prototype of requirements which have finalized for a particular iteration as per customer agreement.

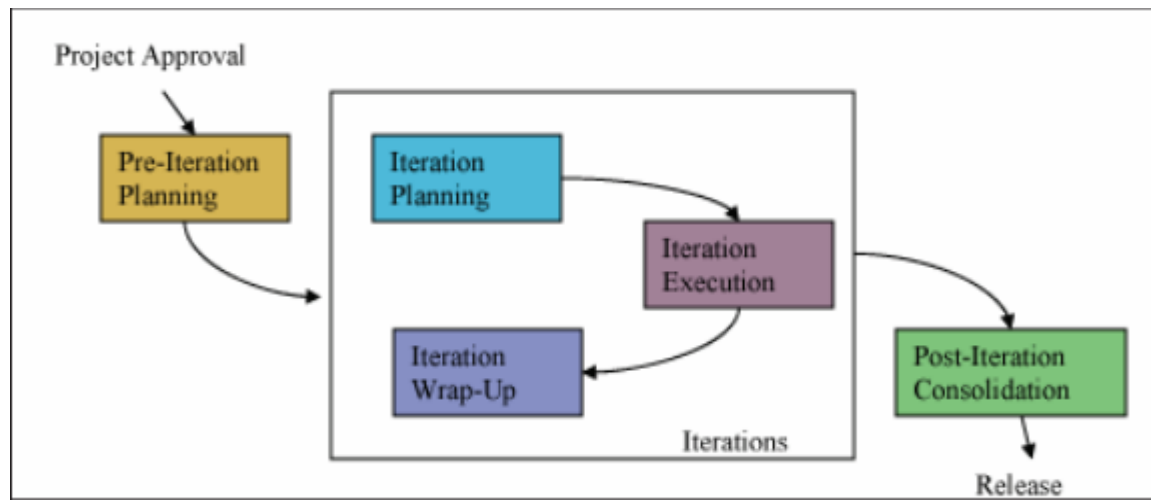

Extreme Programming (XP)

Extreme Programming was created by Kent Beck during his work on the Chrysler Comprehensive Compensation System (C3) payroll project. Beck became the C3 project leader in March 1996 and began to refine the development method used in the project and wrote a book on the method (in October 1999, *Extreme Programming Explained* was published). Chrysler cancelled the C3 project in February 2000, after the company was acquired by Daimler-Benz. Although extreme programming itself is relatively new, many of its practices have been around for some time; the methodology, after all, takes “best practices” to extreme levels. For example, the “practice of test-first development, planning and writing tests before each micro-increment” was used as early as NASA’s Project Mercury, in the early 1960s (Larman 2003). To shorten the total development time, some formal test documents (such as for acceptance testing) have been developed in parallel (or shortly before) the software is ready for testing. A NASA independent test group can write the test procedures, based on formal requirements and logical limits, before the software has been written and integrated with the hardware. In XP, this concept is taken to the extreme level by writing automated tests (**perhaps inside of software modules**) which validate the operation of even small sections of software coding, rather than only testing the larger features. Some other XP practices, such as refactoring, modularity, bottom-up design, and incremental design were described by Leo Brodie in his book published in 1984 *Extreme Programming, or XP*, is a lightweight discipline of software development based on principles of simplicity, communication, feedback, and courage. XP is designed for use with small teams who need to develop software quickly in an environment of rapidly-changing requirements. XP can be summed up in twelve **practices** as discussed below:

i. The Planning Process

The XP planning process allows the XP customer" to define the business value of desired features, and uses cost estimates provided by the programmers, to choose what needs to be done and what needs to be deferred. The effect of XP's planning process is that it is easy to steer the project to success.

ii. Small Releases

XP teams put a simple system into production early, and update it frequently on a very short cycle.

iii. Metaphor

XP teams use a common or system of names" and a common system description that guides development and communication.

iv. Simple Design

A program built with XP should be the simplest program that meets the current requirements. There is not much building for the future". Instead, the focus is on providing business value. Of course it is necessary to ensure that you have a good design, and in XP this is brought about through refactoring", discussed below.

v. Testing

XP teams focus on validation of the software at all times. Programmers develop software by writing tests cases, then software that full-fills the requirements in the tests. Customers provide acceptance tests that enable them to be certain that the features they need are provided.

vi. Refactoring

XP teams improve the design of the system throughout the entire development. This is done by keeping the software clean: without duplication, with high communication, simple, yet complete.

vii. Pair Programming

XP programmers write all production code in pairs, two programmers working together at one machine. Pair programming has been shown by many experiments to produce better software at similar or lower cost than programmers working alone.

viii. Collective Ownership

All the code belongs to all the programmers. This lets the team go at full speed, because when something needs changing, it can be changed without delay.

ix. Continuous Integration

XP teams integrate and build the software system multiple times per day. This keeps all the programmers on the same page, and enables very rapid progress. Perhaps surprisingly, integrating more frequently tends to eliminate integration problems that plague teams who integrate less often.

x. 40-hour Week

Tired programmers make more mistakes. XP teams do not work excessive overtime, keeping themselves fresh, healthy, and effective.

xi. On-site Customer

An XP project is steered by a dedicated individual who is empowered to determine requirements, set priorities, and answer questions as the programmers have them. The effect of being there is that communication improves, with less hard-copy documentation - often one of the most expensive parts of a software project.

xii. Coding Standard

For a team to work effectively in pairs, and to share ownership of all the code, all the programmers need to write the code in the same way, with rules that make sure the code communicates clearly.

XP Corners:

i. Communication

Building software systems requires communicating system requirements to the developers of the system. In formal software development methodologies, this task is accomplished through documentation. Extreme programming techniques can be viewed as methods for rapidly building and disseminating institutional knowledge among members of a development team. The goal is to give all developers a shared view of the system which matches the view held by the users of the system. To this end, extreme programming favors simple designs, common metaphors, collaboration of users and programmers, frequent verbal communication, and feedback.

ii. Simplicity

Extreme Programming encourages starting with the simplest solution. Extra functionality can then be added later. The difference between this approach and more conventional system development methods is the focus on designing and coding for the needs of today instead of those of tomorrow, next week, or next month. Coding and designing for uncertain future requirements implies the risk of spending resources on something that might not be needed. Related to the "communication" value, simplicity in design and coding should improve the quality of communication. A simple design with very simple code could be easily understood by most programmers in the team.

iii. Feedback

Within extreme programming, feedback relates to different dimensions of the system development:

Feedback from the system: by writing unit tests,[5] or running periodic integration tests, the programmers have direct feedback from the state of the system after implementing changes.

Feedback from the customer: The functional tests (aka acceptance tests) are written by the customer and the testers. They will get concrete feedback about the current state of their system. This review is planned once in every two or three weeks so the customer can easily steer the development.

Feedback from the team: When customers come up with new requirements in the planning game the team directly gives an estimation of the time that it will take to implement.

Feedback is closely related to communication and simplicity. Flaws in the system are easily communicated by writing a unit test that proves a certain piece of code will break. The direct feedback from the system tells programmers to recode this part. A customer is able to test the

system periodically according to the functional requirements, known as user stories. To quote Kent Beck, "**Optimism is an occupational hazard of programming. Feedback is the treatment.**"

iv. Courage

Several practices embody courage. One is the commandment to always design and code for today and not for tomorrow. This is an effort to avoid getting bogged down in design and requiring a lot of effort to implement anything else. Courage enables developers to feel comfortable with refactoring their code when necessary.^[5] This means reviewing the existing system and modifying it so that future changes can be implemented more easily. Another example of courage knows when to throw code away: courage to remove source code that is obsolete, no matter how much effort was used to create that source code. Also, courage means persistence: A programmer might be stuck on a complex problem for an entire day, then solve the problem quickly the next day, if only they are persistent.

Principles of XP:

The principles that form the basis of XP are based on the values just described and are intended to foster decisions in a system development project. The principles are intended to be more concrete than the values and more easily translated to guidance in a practical situation.

i. Feedback

Extreme programming sees feedback as most useful if it is done rapidly and expresses that the time between an action and its feedback is critical to learning and making changes. Unlike traditional system development methods, contact with the customer occurs in more frequent iterations. The customer has clear insight into the system that is being developed. He or she can give feedback and steer the development as needed.

Unit tests also contribute to the rapid feedback principle. When writing code, the unit test provides direct feedback as to how the system reacts to the changes one has made. If, for instance, the changes affect a part of the system that is not in the scope of the programmer who made them, that programmer will not notice the flaw. There is a large chance that this bug will appear when the system is in production.

ii. Assuming simplicity

This is about treating every problem as if its solution were "extremely simple". Traditional system development methods say to plan for the future and to code for reusability. Extreme programming rejects these ideas.

The advocates of extreme programming say that making big changes all at once does not work. Extreme programming applies incremental changes: for example, a system might have small releases every three weeks. When many little steps are made, the customer has more control over the development process and the system that is being developed.

iii. Embracing change

The principle of embracing change is about not working against changes but embracing them. For instance, if at one of the iterative meetings it appears that the customer's requirements have changed dramatically, programmers are to embrace this and plan the new requirements for the next iteration.

Extreme Programming Project

From practical view point, the following steps are performed as shown in below:

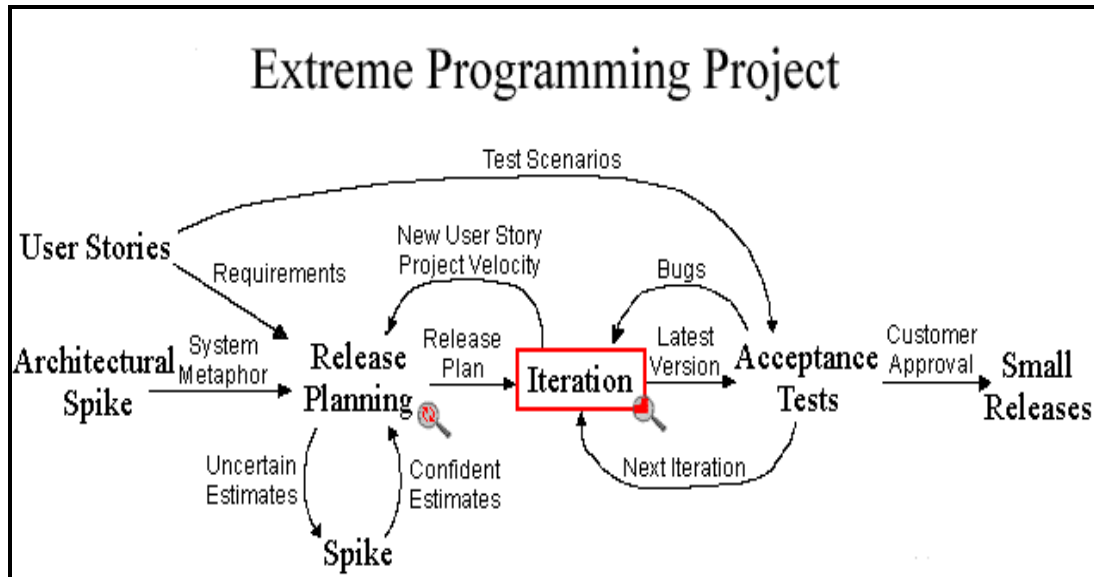

i. User Stories

User stories serve the same purpose as use cases but are not the same. They are used to create time estimates for the **release planning meeting**. They are also used instead of a large requirements document. User Stories are written by the customers as things that the system needs to do for them. They are similar to usage scenarios, except that they are not limited to describing a user interface. They are in the format of about three sentences of text written by the customer in the customer's terminology without techno-syntax.

User stories also drive the creation of the acceptance tests. One or more automated acceptance tests must be created to verify the user story has been correctly implemented. One of the biggest misunderstandings with user stories is how they differ from traditional requirements specifications. The biggest difference is in the level of detail. User stories should only provide enough detail to make a reasonably low risk estimate of how long the story will take to implement. When the time comes to implement the story developers will go to the customer and receive a detailed description of the requirements face to face. Developers estimate how long the stories might take to implement. Each story will get a 1, 2 or 3 week estimate in "ideal development time". This ideal development time is how long it would take to implement the story in code if there were no distractions, no other assignments, and you knew exactly what to do. Longer than 3 weeks means you need to break the story down further. Less than 1 week and you

are at too detailed a level, combine some stories. About 80 user stories plus or minus 20 is a perfect number to create a release plan during release planning. Another difference between stories and a requirements document is a focus on user needs. You should try to avoid details of specific technology, data base layout, and algorithms. You should try to keep stories focused on user needs and benefits as opposed to specifying GUI layouts.

There is no specific format for writing the user stories; user story should contain user story number, 2-3 sentence requirement, priority of the requirement; each of these components are to be filled by the user (customer) and then developer write the estimated time in weeks to complete the user story. A sample user story is as below:

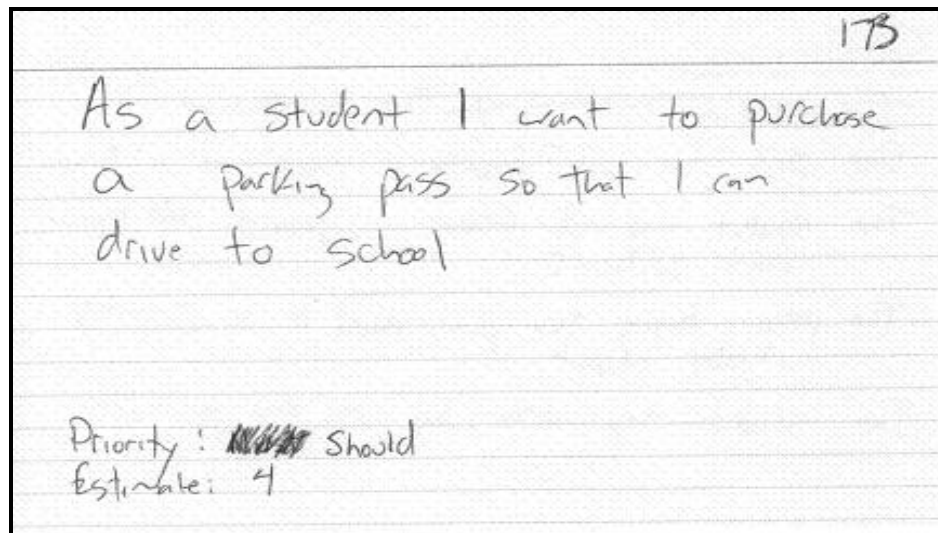

ii. Release Planning

A release planning meeting is used to create a release plan, which lays out the overall project. The release plan is then used to create iteration plans for each individual iteration. It is important for technical people to make the technical decisions and business people to make the business decisions. Release planning has a set of rules that allows everyone involved with the project to make their own decisions. The rules define a method to negotiate a schedule everyone can commit to. The essence of the release planning meeting is for the development team to estimate each user story in terms of ideal programming weeks. An ideal week is how long you imagine it would take to implement that story if you had absolutely nothing else to do. No dependencies, no extra work, but do include tests. The customer then decides what story is the most important or has the highest priority to be completed. User stories are printed or written on cards as shown in the above section. Together developers and customers move the cards around on a large table to create a set of stories to be implemented as the first (or next) release. A useable, testable system that makes good business sense delivered early is desired. You may plan by time or by scope. The project velocity is used to determine either how many stories can be implemented before a given date (time) or how long a set of stories will take to finish (scope). When planning by time multiply the number of iterations by the project velocity to determine how many user stories can be completed. When planning by scope divide the total weeks of estimated user stories by the project velocity to determine how many iteration till the release is ready. Individual iterations are planned in detail just before each iteration begins and not in advance. When the final release plan is created and is displeasing to management it is tempting to just change the estimates for the user stories. You must not do this. The estimates are valid and will be required as-is during the iteration planning meetings. Underestimating now will cause problems later. Instead negotiate an acceptable release plan. Negotiate until the developers, customers, and managers can all agree to the release plan. The base philosophy of release planning is that a project may be quantified by four variables; scope, resources, time, and quality.

iii. Release Plan

After user stories have been written you can use a release planning meeting to create a release plan. The release plan specifies which user stories are going to be implemented for each system release and dates for those releases. This gives a set of user stories for customers to choose from during the iteration planning meeting to be implemented during the next iteration. These selected stories are then translated into individual programming tasks to be implemented during the iteration to complete the stories. Stories are also translated into acceptance tests during the iteration. These acceptance tests are run during this iteration and subsequent iterations to verify when the stories are finished correctly and continue to work correctly.

iv. Acceptance Test

Acceptance tests are created from user stories. During iteration the user stories selected during the iteration planning meeting will be translated into acceptance tests. The customer specifies scenarios to test when a user story has been correctly implemented. A story can have one or many acceptance tests, whatever it takes to ensure the functionality works. Acceptance tests are black box system tests. Each acceptance test represents some expected result from the system. Customers are responsible for verifying the correctness of the acceptance tests and reviewing test scores to decide which failed tests are of highest priority. Acceptance tests are also used as regression tests prior to a production release. A user story is not considered complete until it has passed its acceptance tests. This means that new acceptance tests must be created each iteration or the development team will report zero progress. Quality assurance (QA) is an essential part of the XP process. On some projects QA is done by a separate group, while on others QA will be an integrated into the development team itself. In either case XP requires development to have much closer relationship with QA. Acceptance tests should be automated so they can be run often. It is the team's responsibility to schedule time each iteration to fix any failed tests. The name acceptance tests were changed from functional tests. This better reflects the intent, which is to guarantee that customer's requirements have been met and the system is acceptable.

v. Small Releases

The development team needs to release iterative versions of the system to the customers often. Some teams deploy new software into production every day. At the very least you will want to get new software into production every week or two. At the end of every iteration you will have

tested, working, production ready software to demonstrate to your customers. The decision to put it into production is theirs. The release planning meeting is used to plan small units of functionality that make good business sense and can be released into the customer's environment early in the project. This is critical to getting valuable feedback in time to have an impact on the system's development. The longer you wait to introduce an important feature to the system's users the less time you will have to fix it.

LECTURE NO: 3

Objective:

This lecture will simulate the XP – Planning game. There will be two teams and each team will be required to perform given task as per XP- Planning game rules.

XP – Planning Game:

- There are 2 teams which consists of following roles:
 - i. Customer (3)
 - ii. Developer(3)
 - iii. Each team member will play the role of Customer and Developer
 - iv. Acceptance test will be conducted by Host

Phases

- I. Sample User story to be shown and Sample Tasks.
- II. Estimation of Stories by Developer
- III. Selecting the stories for implementation -Customer
- IV. Implementation – by Developer
- V. Total iterations: 2

Game Rules

i. Step – 1 :

Each team will estimate the “User Stories” along with task by performing the following activities:

- a. Look at the contents of the envelope
- b. Take the cards for iteration 1
- c. Read all the stories
- d. Ask questions
- e. Order the stories: how long does this story take?
- f. Circle the estimation-units on the story cards

ii. Step – 2 :

- a. Choose story cards for your budget (time)
- b. Order the cards in order of implementation
- c. Write the plan on the score sheet

iii. Step -3 : Implementation

- a. Take the first card of the plan
- b. Think. Talk. How are you going to do this story?
- c. Time Starts
- d. Implement the story
- e. Mark the story on the score sheet after implementation
- f. Take the next story until end of time

How Score will be calculated

- Business values will be awarded only complete implementation of requirements on Game Score Sheet
- Deduction of half business points if planned story not finished
- Finish Unplanned story will count half business value
- Project Velocity** i-e sum of all the completed business points; will be calculated using Game Score Sheet for each iteration.
- Team with more Velocity will be the winner

Total Iterations: 2

Iteration -1 Schedule

Task	Time (minute)
Iteration -1 (Total Time)	35
Estimation	10
Planning	5
Implementation - Explanation	15
Debriefing	5

Iteration -2 Schedule

Task	Time
Iteration -1	25
Estimation	5
Planning	5
Implementation	5
Debriefing	5

LECTURE NO: 4

Objective:

In this lecture we will discuss Rational Unified Processes (RUP) in detail along with its phases in both dimensions and deliverables.

What is the Rational Unified Process?

The Rational Unified Process is a process product, developed and maintained by Rational Software. The development team for the Rational Unified Process is working closely with customers, partners, Rational's product groups as well as Rational's consultant organization, to ensure that the process is continuously updated and improved upon to reflect recent experiences and evolving and proven best practices. The Rational Unified Process enhances team productivity, by providing every team member with easy access to a knowledge base with guidelines, templates and tool mentors for all critical development activities. By having all team members accessing the same knowledge base, no matter if you work with requirements, design, test, project management, or configuration management, we ensure that all team members share a common language, process and view of how to develop software. The Rational Unified Process activities create and maintain models. Rather than focusing on the production of large amount of paper documents, the Unified Process emphasizes the development and maintenance of models—semantically rich representations of the software system under development.

The Rational Unified Process is a guide for how to effectively use the Unified Modeling Language (UML). The UML is an industry-standard language that allows us to clearly communicate requirements, architectures and designs. The UML was originally created by Rational Software, and is now maintained by the standards organization Object Management Group (OMG).

The Rational Unified Process is supported by tools, which automate large parts of the process. They are used to create and maintain the various artifacts—models in particular—of the software engineering process: visual modeling, programming, testing, etc. They are invaluable in supporting all the bookkeeping associated with the change management as well as the configuration management that accompanies each iteration. The Rational Unified Process is a configurable process. No single process is suitable for all software development. The Unified Process fits small development teams as well as large development organizations. The Unified

Process is founded on a simple and clear process architecture that provides commonality across a family of processes. Yet, it can be varied to accommodate different situations. It contains a Development Kit, providing support for configuring the process to suit the needs of a given organization. The Rational Unified Process captures many of the best practices in modern software development in a form that is suitable for a wide range of projects and organizations. The fundamental practices are discussed in next section.

Effective Deployment of 6 Best Practices:

The Rational Unified Process describes how to effectively deploy commercially proven approaches to software development for software development teams. These are called “**best practices**” not so much because you can precisely quantify their value, but rather, because they are observed to be commonly used in industry by successful organizations. The Rational Unified Process provides each team member with the guidelines, templates and tool mentors necessary for the entire team to take full advantage of among others the following best practices:

1. Develop software iteratively
2. Manage requirements
3. Use component-based architectures
4. Visually model software
5. Verify software quality
6. Control changes to software

1. Develop Software Iteratively:

Given today’s sophisticated software systems, it is not possible to sequentially first define the entire problem, design the entire solution, build the software and then test the product at the end. An iterative approach is required that allows an increasing understanding of the problem through successive refinements, and to incrementally grow an effective solution over multiple iterations. The Rational Unified Process supports an iterative approach to development that addresses the highest risk items at every stage in the lifecycle, significantly reducing a project’s risk profile. This iterative approach helps you attack risk through demonstrable progress frequent, executable releases that enable continuous end user involvement and feedback, because each iteration ends with an executable release, the development team stays focused on producing results, and

frequent status checks help ensure that the project stays on schedule. An iterative approach also makes it easier to accommodate tactical changes in requirements, features or schedule.

2. Manage Requirements

The Rational Unified Process describes how to elicit, organize, and document required functionality and constraints; track and document tradeoffs and decisions; and easily capture and communicate business requirements. The notions of use case and scenarios proscribed in the process has proven to be an excellent way to capture functional requirements and to ensure that these drive the design, implementation and testing of software, making it more likely that the final system fulfills the end user needs. They provide coherent and traceable threads through both the development and the delivered system.

3. Use Component-based Architectures

The process focuses on early development and base lining of a robust executable architecture, prior to committing resources for full-scale development. It describes how to design a resilient architecture that is flexible, accommodates change, is intuitively understandable, and promotes more effective software reuse. The Rational Unified Process supports component-based software development. Components are non-trivial modules, subsystems that fulfill a clear function. The Rational Unified Process provides a systematic approach to defining an architecture using new and existing components. These are assembled in a well-defined architecture, either ad hoc, or in a component infrastructure such as the Internet, CORBA, and COM, for which an industry of reusable components is emerging.

4. Visually Model Software

The process shows you how to visually model software to capture the structure and behavior of architectures and components. This allows you to hide the details and write code using “graphical building blocks.” Visual abstractions help you communicate different aspects of your software; see how the elements of the system fit together; make sure that the building blocks are consistent with your code; maintain consistency between a design and its implementation; and promote unambiguous communication. The industry standard Unified Modeling Language (UML), created by Rational Software, is the foundation for successful visual modeling.

5. Verify Software Quality

Poor application performance and poor reliability are common factors which dramatically inhibit the acceptability of today's software applications. Hence, quality should be reviewed with respect to the requirements based on reliability, functionality, application performance and system performance. The Rational Unified Process assists you in the planning, design, implementation, execution, and evaluation of these test types. Quality assessment is built into the process, in all activities, involving all participants, using objective measurements and criteria, and not treated as an afterthought or a separate activity performed by a separate group.

6. Control Changes to Software

The ability to manage change is making certain that each change is acceptable, and being able to track changes is essential in an environment in which change is inevitable. The process describes how to control, track and monitor changes to enable successful iterative development. It also guides you in how to establish secure workspaces for each developer by providing isolation from changes made in other workspaces and by controlling changes of all software artifacts (e.g., models, code, documents, etc.). And it brings a team together to work as a single unit by describing how to automate integration and build management.

Process Overview

Two Dimensions

The process can be described in two dimensions, or along two axis:

- The horizontal axis represents time and shows the dynamic aspect of the process as it is enacted, and it is expressed in terms of cycles, phases, iterations, and milestones.

- The vertical axis represents the static aspect of the process: how it is described in terms of activities, artifacts, workers and workflows.

The Iterative Model graph shows how the process is structured along two

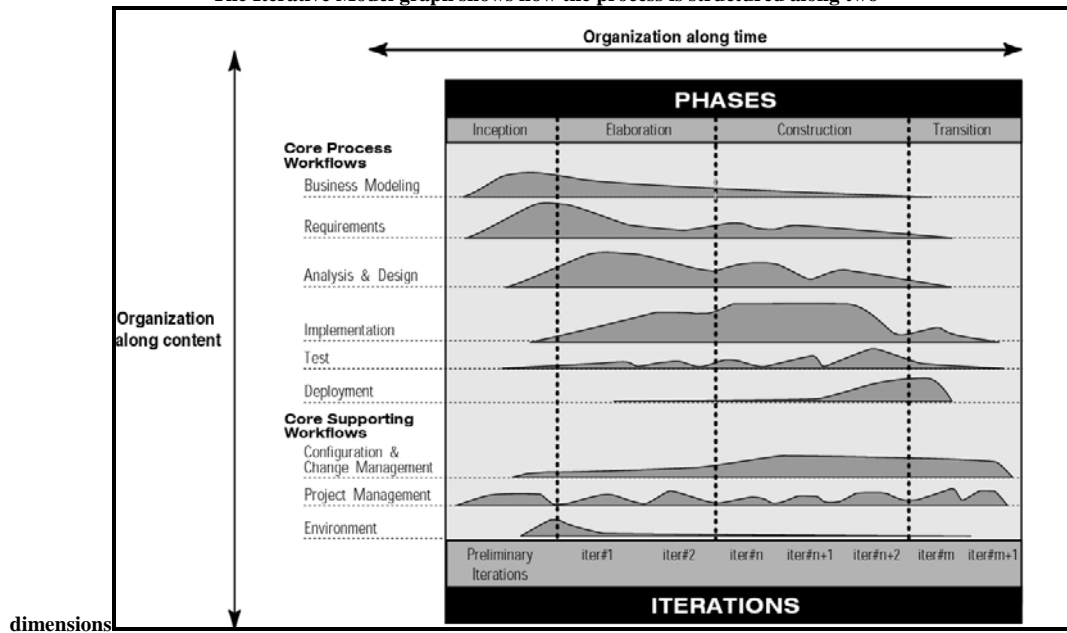

Phases and Iterations - The Time Dimension

This is the dynamic organization of the process along time. The software lifecycle is broken into *cycles*, each cycle working on a new generation of the product. The Rational Unified Process divides one development cycle in four consecutive *phases*.

- i. Inception phase
- ii. Elaboration phase
- iii. Construction phase
- iv. Transition phase

Each phase is concluded with a well-defined *milestone*—a point in time at which certain critical decisions must be made and therefore key goals must have been achieved

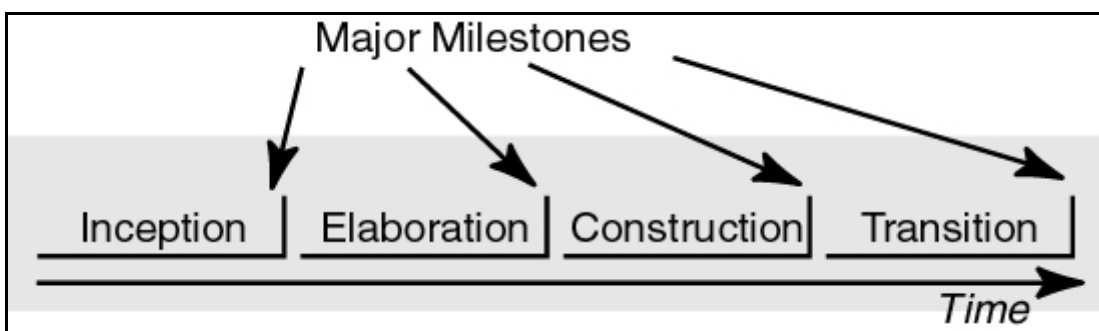

i. Inception Phase

During the inception phase, you establish the business case for the system and delimit the project scope. To accomplish this you must identify all external entities with which the system will interact (actors) and define the nature of this interaction at a high-level. This involves identifying all use cases and describing a few significant ones. The business case includes success criteria, risk assessment, and estimate of the resources needed, and a phase plan showing dates of major milestones.

The outcome of the inception phase is:

- A vision document: a general vision of the core project's requirements, key features, and main constraints.
- A initial use-case model (10% -20%) complete).
- An initial project glossary (may optionally be partially expressed as a domain model).
- An initial business case, which includes business context, success criteria (revenue projection, market recognition, and so on), and financial forecast.
- An initial risk assessment.
- A project plan, showing phases and iterations.
- A business model, if necessary.
- One or several prototypes.

Milestone: Lifecycle Objectives

At the end of the inception phase is the first major project milestone: **the Lifecycle Objectives Milestone.**

The evaluation criteria for the inception phase are:

- Stakeholder concurrence on scope definition and cost/schedule estimates.
- Requirements understanding as evidenced by the fidelity of the primary use cases.
- Credibility of the cost/schedule estimates, priorities, risks, and development process.
- Depth and breadth of any architectural prototype that was developed.
- Actual expenditures versus planned expenditures.

- The project may be cancelled or considerably re-thought if it fails to pass this milestone.

ii. Elaboration Phase

The purpose of the elaboration phase is to analyze the problem domain, establish a sound architectural foundation, develop the project plan, and eliminate the highest risk elements of the project. To accomplish these objectives, you must have the “mile wide and inch deep” view of the system. Architectural decisions have to be made with an understanding of the whole system: its scope, major functionality and nonfunctional requirements such as performance requirements. It is easy to argue that the elaboration phase is the most critical of the four phases. At the end of this phase, the hard “engineering” is considered complete and the project undergoes its most important day of reckoning: the decision on whether or not to commit to the construction and transition phases. For most projects, this also corresponds to the transition from a mobile, light and nimble, low-risk operation to a high-cost, high-risk operation with substantial inertia. While the process must always accommodate changes, the elaboration phase activities ensure that the architecture, requirements and plans are stable enough, and the risks are sufficiently mitigated, so you can predictably determine the cost and schedule for the completion of the development. Conceptually, this level of fidelity would correspond to the level necessary for an organization to commit to a fixed-price construction phase.

In the elaboration phase, an executable architecture prototype is built in one or more iterations, depending on the scope, size, risk, and novelty of the project. This effort should at least address the critical use cases identified in the inception phase, which typically expose the major technical risks of the project. While an evolutionary prototype of a production-quality component is always the goal, this does not exclude the development of one or more exploratory, throwaway prototypes to mitigate specific risks such as design/requirements trade-offs, component feasibility study, or demonstrations to investors, customers, and end-users.

The outcome of the elaboration phase is:

- A use-case model (at least 80% complete) — all use cases and actors have been identified, and most use-case descriptions have been developed.
- Supplementary requirements capturing the non functional requirements and any requirements that are not associated with a specific use case.
- A Software Architecture Description.
- An executable architectural prototype.

- A revised risk list and a revised business case.
- A development plan for the overall project, including the coarse-grained project plan, showing iterations” and evaluation criteria for each iteration.
- An updated development case specifying the process to be used.
- A preliminary user manual (optional).

Milestone: Lifecycle Architecture

At the end of the elaboration phase is the second important project milestone, the Lifecycle Architecture Milestone. At this point, you examine the detailed system objectives and scope, the choice of architecture, and the resolution of the major risks.

The main evaluation criteria for the elaboration phase involve the answers to these questions:

- Is the vision of the product stable?
- Is the architecture stable?
- Does the executable demonstration show that the major risk elements have been addressed and credibly resolved?
- Is the plan for the construction phase sufficiently detailed and accurate? Is it backed up with a credible basis of estimates?
- Do all stakeholders agree that the current vision can be achieved if the current plan is executed to develop the complete system, in the context of the current architecture?
- Is the actual resource expenditure versus planned expenditure acceptable?
- The project may be aborted or considerably re-thought if it fails to pass this milestone

iii. Construction Phase

During the construction phase, all remaining components and application features are developed and integrated into the product, and all features are thoroughly tested. The construction phase is, in one sense, a manufacturing process where emphasis is placed on managing resources and controlling operations to optimize costs, schedules, and quality. In this sense, the management mindset undergoes a transition from the development of intellectual property during inception and elaboration, to the development of deployable products during construction and transition. Many

projects are large enough that parallel construction increments can be spawned. These parallel activities can significantly accelerate the availability of deployable releases; they can also increase the complexity of resource management and workflow synchronization. A robust architecture and an understandable plan are highly correlated. In other words, one of the critical qualities of the architecture is its ease of construction. This is one reason why the balanced development of the architecture and the plan is stressed during the elaboration phase. The outcome of the construction phase is a product ready to put in hands of its end-users. At minimum, it consists of:

- The software product integrated on the adequate platforms.
- The user manuals.
- A description of the current release.

Milestone: Initial Operational Capability

At the end of the construction phase is the third major project milestone (Initial Operational Capability Milestone).

- At this point, you decide if the software, the sites, and the users are ready to go operational, without exposing the project to high risks. This release is often called a **“beta” release**.
- The evaluation criteria for the construction phase involve answering these questions:
 - Is this product release stable and mature enough to be deployed in the user community?
 - Are all stakeholders ready for the transition into the user community?
 - Are the actual resource expenditures versus planned expenditures still acceptable?
 - Transition may have to be postponed by one release if the project fails to reach this milestone.

iv. Transition Phase

The purpose of the transition phase is to transition the software product to the user community. Once the product has been given to the end user, issues usually arise that require you to develop new releases, correct some problems, or finish the features that were postponed. The transition phase is entered when a baseline is mature enough to be deployed in the end-user domain. This typically requires that some usable subset of the system has been completed to an acceptable level of quality and that user documentation is available so that the transition to the user will provide positive results for all parties. This includes:

- **“Beta testing”** to validate the new system against user expectations
- Parallel operation with a legacy system that it is replacing conversion of operational databases
- Training of users and maintainers
- roll-out the product to the marketing, distribution, and sales teams

The transition phase focuses on the activities required to place the software into the hands of the users. Typically, this phase includes several iterations, including beta releases, general availability releases, as well as bug-fix and enhancement releases. Considerable effort is expended in developing user-oriented documentation, training users, supporting users in their initial product use, and reacting to user feedback. At this point in the lifecycle, however, user feedback should be confined primarily to product tuning, configuring, installation, and usability issues. The primary objectives of the transition phase include:

- Achieving user self-supportability
- Achieving stakeholder concurrence that deployment baselines are complete and consistent with the evaluation criteria of the vision
- Achieving final product baseline as rapidly and cost effectively as practical
- This phase can range from being very simple to extremely complex, depending on the type of product. For example, a new release of an existing desktop product may be very simple, whereas replacing a nation's air-traffic control system would be very complex.

Milestone: Product Release

At the end of the transition phase is the fourth important project milestone, the Product Release Milestone. At this point, you decide if the objectives were met, and if you should start another development cycle. In some cases, this milestone may coincide with the end of the inception phase for the next cycle. The primary evaluation criteria for the transition phase involve the answers to these questions:

- Is the user satisfied?
- Are the actual resources expenditures versus planned expenditures still acceptable?

Iterations

Each phase in the Rational Unified Process can be further broken down into iterations. An *iteration* is a complete development loop resulting in a release (internal or external) of an executable product, a subset of the final product under development, which grows incrementally from iteration to iteration to become the final system.

Benefits of an iterative approach

Compared to the traditional waterfall process, the iterative process has the following advantages:

- Risks are mitigated earlier
- Change is more manageable
- Higher level of reuse
- The project team can learn along the way
- Better overall quality

Static Structure of the Process

A process describes *who* is doing *what*, *how*, and *when*. The Rational Unified Process is represented using four primary modeling elements:

- Workers, the ‘who’
- Activities, the ‘how’
- Artifacts, the ‘what’
- Workflows, the ‘when’

Activities, Artifacts, and Workers

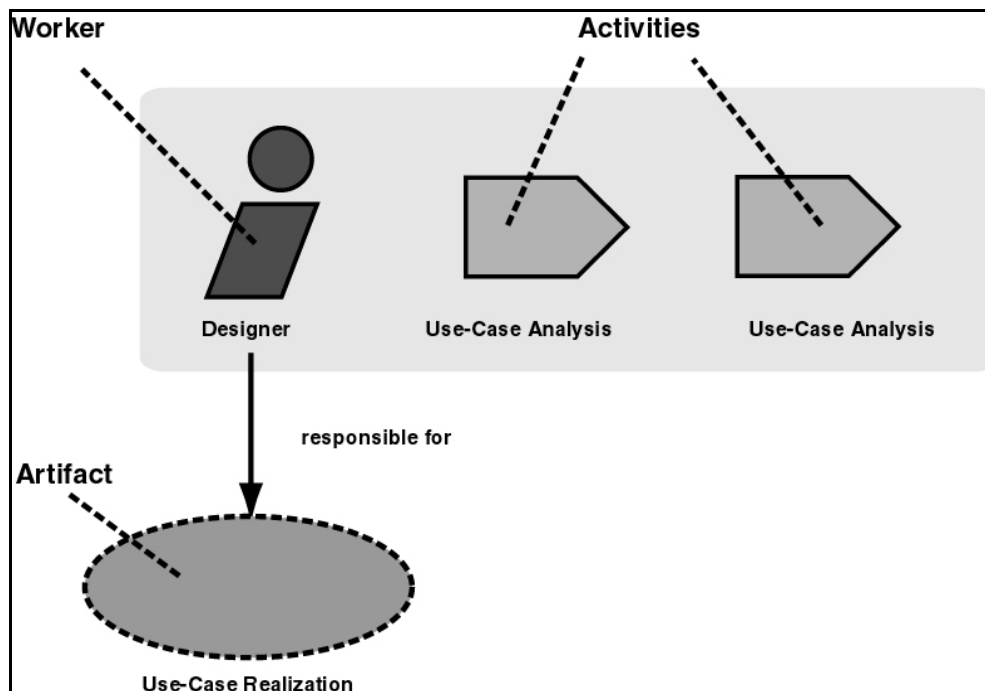

Workers, activities, and artifacts.

Worker

A *worker* defines the behavior and responsibilities of an individual, or a group of individuals working together as a team. You could regard a worker as a "hat" an individual can wear in the project. One individual may wear many different hats. This is an important distinction because it is natural to think of a worker as the individual or team itself, but in the Unified Process the worker is more the role defining how the individuals should carry out the work. The responsibilities we assign to a worker include both to perform a certain set of activities as well as being owner of a set of artifacts.

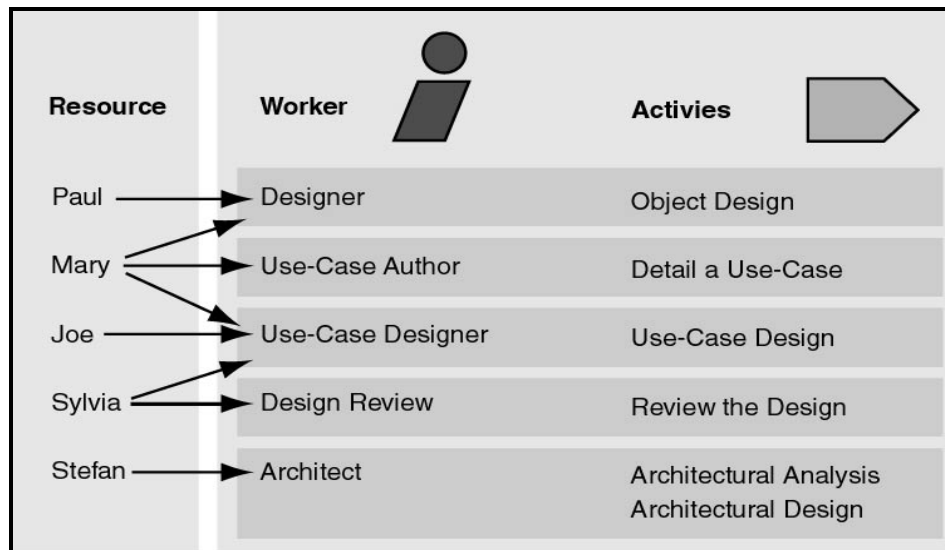

People and Workers

Activity

An **activity** of a specific worker is a unit of work that an individual in that role may be asked to perform. The activity has a clear purpose, usually expressed in terms of creating or updating some artifacts, such as a model, a class, a plan. Every activity is assigned to a specific worker. The granularity of an activity is generally a few hours to a few days; it usually involves one worker, and affects one or only a small number of artifacts. An activity should be usable as an element of planning and progress; if it is too small, it will be neglected, and if it is too large, progress would have to be expressed in terms of an activity's parts.

Example of activities:

- **Plan an iteration**, for the Worker: Project Manager
- **Find use cases and actors**, for the Worker: System Analyst
- **Review the design**, for the Worker: Design Reviewer
- **Execute performance test**, for the Worker: Performance Tester

Artifact

An artifact is a piece of information that is produced, modified, or used by a process. Artifacts are the tangible products of the project, the things the project produces or uses while working towards the final product. Artifacts are used as input by workers to perform an activity, and are the result or output of such activities. In object-oriented design terms, as activities are operations on an active object (the worker), artifacts are the parameters of these activities.

- Artifacts may take various shapes or forms:
 - A model, such as the Use-Case Model or the Design Model
 - A model element, i.e. an element within a model, such as a class, a use case or a subsystem
 - A document, such as Business Case or Software Architecture Document
 - Source code
 - Executables

Workflows

A mere enumeration of all workers, activities and artifacts does not quite constitute a process. We need a way to describe meaningful sequences of activities that produce some valuable result, and to show interactions between workers. A *workflow* is a sequence of activities that produces a result of observable value.

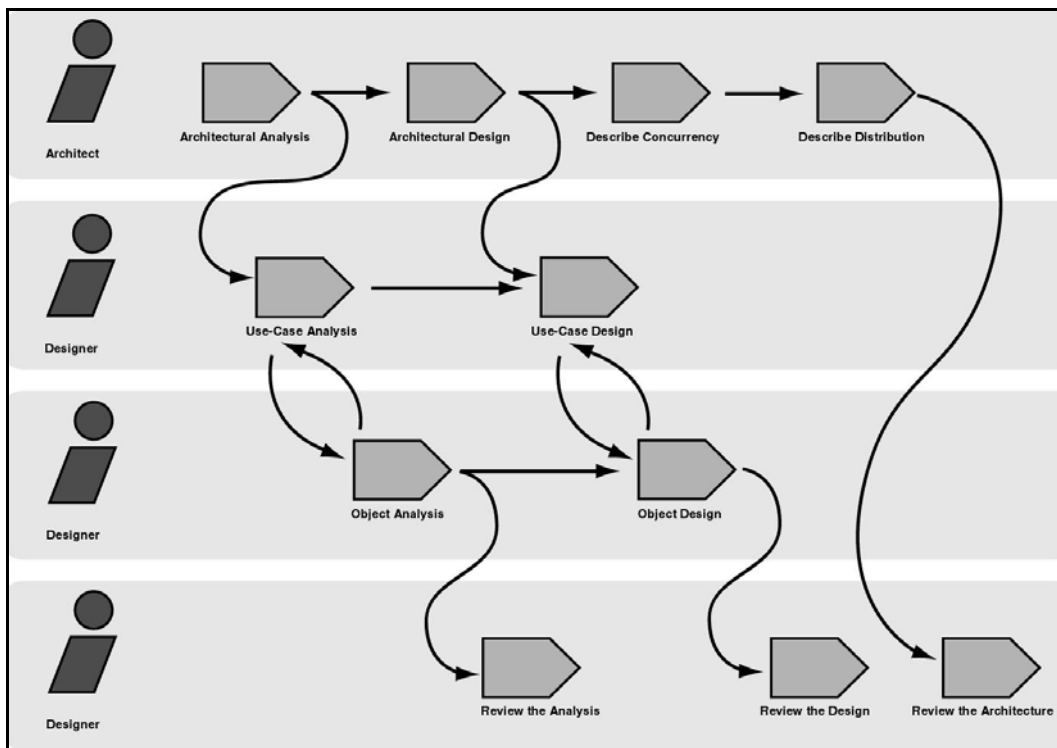

Example of workflow

Note that it is not always possible or practical to represent all of the dependencies between activities. Often two activities are more tightly interwoven than shown, especially when they involve the same worker or the same individual. People are not machines, and the workflow cannot be interpreted literally as a program for people, to be followed exactly and mechanically.

LECTURE NO: 5

Objective:

This chapter will provide the motivation for software design in a structured manner; software design life cycle will be discussed in detail.

Motivation for Software Design

A little story

The US standard railroad gauge (distance between the rails) is 4 feet, 8.5 inches. That's an exceedingly odd number. *Why was that gauge used?* Because that's the way they built them in England, and English expatriates built the US Railroads. ***Why did the English build them like that?*** Because the first rail lines were built by the same people who built the pre-railroad tramways, and that's the gauge they used. ***Why did "they" use that gauge then?*** Because the people who built the tramways used the same jigs and tools that they used for building wagons, which used that wheel spacing. ***Okay! Why did the wagons have that particular odd wheel spacing?*** Well, if they tried to use any other spacing, the wagon wheels would break on some of the old long distance roads in England, because that's the spacing of the wheel ruts. ***So who built those old rutted roads?*** Imperial Rome built the first long distance roads in Europe (and England) for their legions. The roads have been used ever since. ***And the rut in the roads?*** Roman war chariots formed the initial ruts, which everyone else had to match for fear of destroying their wagon wheels. Since the chariots were made for Imperial Rome, they were all alike in the matter of wheel spacing. ***So the United States standard railroad gauge of 4 feet, 8.5 inches is derived from the original specifications for an Imperial Roman war chariot.***

Lesson learn: design usually stay for years

Introduction to Software Design

As the size and complexity of software systems increases, the design problem goes beyond the algorithms and data structures of the computation: designing and specifying the overall system structure emerges as a new kind of problem. Structural issues include gross organization and

global control structure; protocols for communication, synchronization, and data access; assignment of functionality to design elements; physical distribution; composition of design elements; scaling and performance; and selection among design alternatives. This is the software architecture level of design. There is a considerable body of work on this topic, including module interconnection languages, templates and frameworks for systems that serve the needs of specific domains, and formal models of component integration mechanisms. In addition, an implicit body of work exists in the form of descriptive terms used informally to describe systems. And while there is not currently a well-defined terminology or notation to characterize architectural structures, good software engineers make common use of architectural principles when designing complex software. Many of the principles represent rules of thumb or idiomatic patterns that have emerged informally over time. Others are more carefully documented as industry and scientific standards. It is increasingly clear that effective software engineering requires facility in architectural software design. First, it is important to be able to recognize common paradigms so that high-level relationships among systems can be understood and so that new systems can be built as variations on old systems. Second, getting the right architecture is often crucial to the success of a software system design; the wrong one can lead to disastrous results. Third, detailed understanding of software architectures allows the engineer to make principled choices among design alternatives. Fourth, an architectural system representation is often essential to the analysis and description of the high level properties of a complex system.

Software design and SDLC

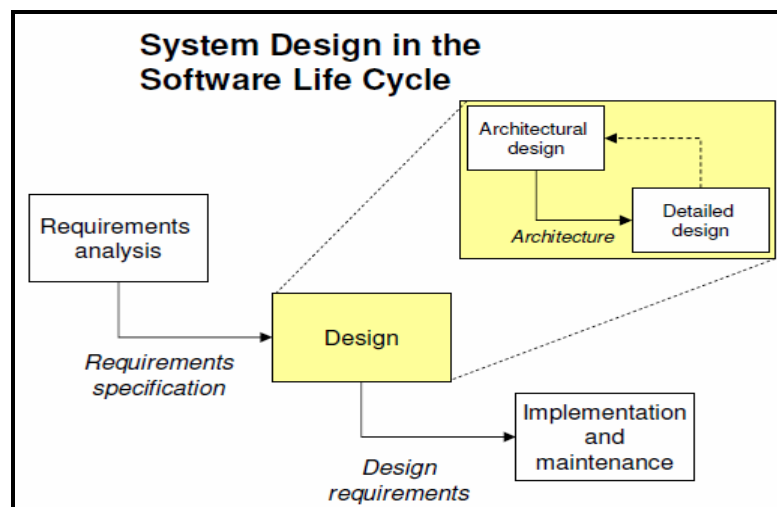

Structures are the most stable things in your system and they have to hold even after years. Software design lays down a structure for the system and divides the future system in parts which can be managed. If we do it right, we are awarded with further abstraction. The goals of software design are to understand the different interrelationships between requirements and design so that classification at different higher-level architectural patterns and their interrelationship to design patterns can be achieved. It will enable us to decide on the adequacy of a specific architectural pattern for a certain problem and will enable us know how and when to apply architectural patterns to make a certain system design. Structured software design will help us in making the transition from a logical design to a physical design by using UML to document a system design and then we will be able to validate if a specific implementation is compliant with the intended architecture.

The fact about software as compare to design of the other things in the world is if we able to implement the requirement correctly or not we will be able to know it by the end of the project but how stable is our design from maintenance view point? We will be able to know this after many years. As shown below software without proper software design will lead to unstable design and will be a maintenance nightmare as opposite to software with proper design process.

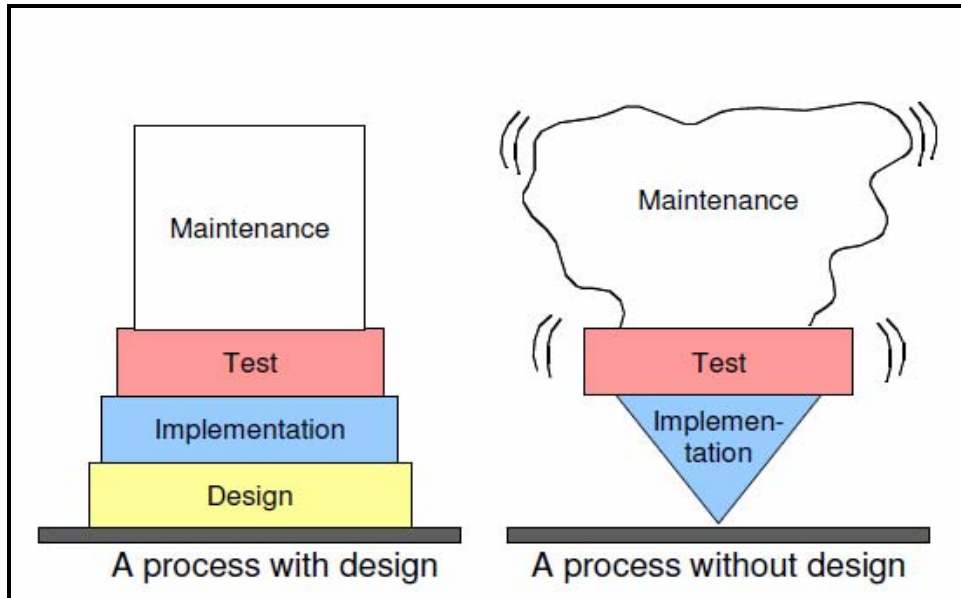

This is also a fact about software that software development is for once but software maintenance is forever and it depend on design of the software how easier software maintenance would be both in term of cost and time.

Software design Defined:

“The process of defining the architecture, components, interfaces, and other characteristics of a system or component”

Architectural design:

“The process of defining a collection of hardware and software components and their interfaces to establish the framework for the development of a computer system”

Software design is an iterative process which keeps on improving as we understand the problem domain as we design more; it is a complicated process so therefore it needed to be modeled Similar to an architect’s blueprint. Architectural design of the software is the highest level of software design from which detail level of design emerges as we further grilled the requirements to develop an architectural model. A model is an abstraction of the underlying problem. Software designs should be modeled, and expressed as a series of views by using modeling language such as UML

Architectural Design Activities:

- i. Hierarchical decomposition of the system into subsystems
- ii. Determine components and assign to subsystems
- iii. Determine relationships between components
- iv. Define communication between components (Model of the system) architecture

Detailed Design

“The process of analyzing design alternatives and defining the architecture, components, interfaces, and timing and sizing estimates for a system or component”

Detailed Design Activities:

- i. Determine the components’ interfaces
- ii. Determine the usage between components Specification of components

Software Architecture:

According to Shaw and Garlan:

“The Software Architecture of a system consists of a description of the system elements, interactions between the system elements, patterns that guide the system elements and constraints on the relationships between system elements”

OR

“The software architecture of a program or computing system is the structure or *structures of the system*, which comprise software *elements*, the *externally visible properties of those elements*, and the *relationships among them*”

Architectural design provide us with a more abstract view of the overall software design, and its helpful for communication and complexity management.

Problem: There is no standard definition

And another problem is the fact that “Change is the only constant” so it might happen that initial architecture of the software may be changed drastically with the passage of time and may become useless in the end.

Lehman’s First Law of Software Evolution

“A program that is used as an implementation of software specification reflects some reality undergoes continual change or becomes progressively less useful.”

Result:

The System will change (or it will vanish)

Modeling as a Design Technique

Designs are too complicated to develop from scratch; good designs tend to be build using model:

- 1) Abstract different views of the system
- 2) Build models using precise notations (e.g., UML)
- 3) Verify that the models satisfy the requirements
- 4) Gradually add details to transform the models into the design

LECTURE NO: 6 && 7

Objectives:

In these two lectures we will discuss principles of the software design using design taxonomy as discussed in lecture no 5

Software Design Components

When we design the design of the software, we have to deal with three types of components that make up the design of the software, these components are as follow:

- i. Principle
- ii. Criteria
- iii. Techniques

i. Principle

This component of the software design has multiple sub-components and out of these subcomponents we have to decide and design the problem under discussion depending upon the nature of the problem.

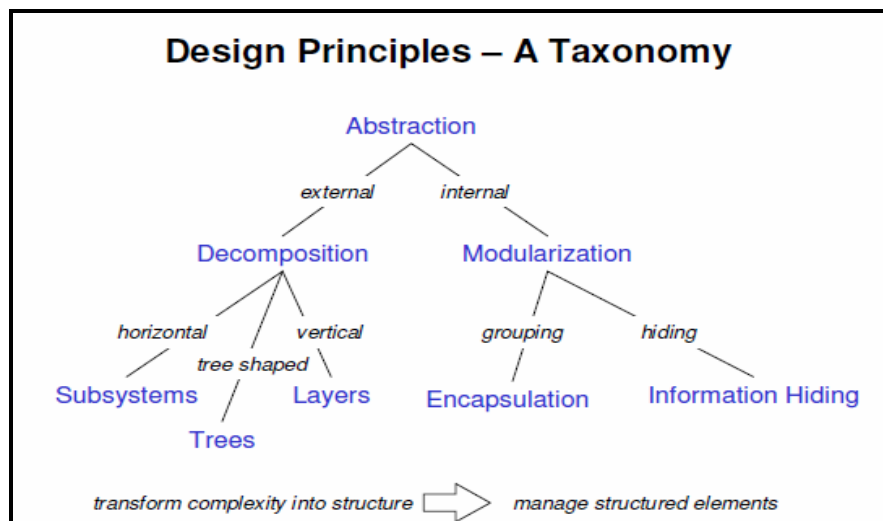

a. Abstraction

As seen in the diagram above, abstraction is the root of the design principle so before actually starting discussion let us try to find its practical meaning first using an example.

Myth about Abstraction

- Our task is to design a management information system for a hospital; it should include patient management, doctor's management, laboratory management, inventory of equipment and medicines.

i. Programmers Approach:

Let us first discuss the approach which will be followed by a typical programmer:

Typically programmer will start by saying and thinking about the technology aspect for implementation without going into the details of design component of the system. This will engage the programmer with technology aspect earlier in the design cycle where there will be a not needed discussion between technological implications on to be **designed software design!!**

ii. System Architect Approach

The approach of System architect would be to forget the technology, first understand what to do in detail then generate Requirement Specification (RS) and from RS generate Functional specification (FS) and design document (DD) – This is **“Abstraction”**

Abstraction Defined:

“A view of an object that focuses on the information relevant to a particular purpose and ignores the remainder of the information”

IEEE Standard 610.12-1990

The abstraction notion is central to understanding the representational requirements of Design activities. Put very simply, the use of abstractions during design gives the designer freedom to ignore certain details, for the time being, and to determine or design the "big picture" aspects of his design. The use of abstractions allows the designer to freely shift its focus from one part of the design to another or from one Level of Detail (LoD) to a different one. An abstraction is simply an entity's representation with some of the details omitted. The omitted details can be attributes, relationships among sub-entities or sub-entities. Abstraction is simply removal of unnecessary details which will help to design a complex system, we must focus on identifying what **about that part other parts should know in order to design their part**. Abstraction is the process or result of generalization by reducing the information content of a concept or an observable phenomenon, typically in order to retain only information which is relevant for a particular purpose. It is a process by which higher concepts are derived from the usage and classification of literal ("real" or "concrete") concepts, first principles (defined below), or other methods. An "abstraction" (noun) is a concept that acts as super-categorical noun for all subordinate concepts, and connects any related concepts as a *group*, *field*, or *category*. It may be formed by reducing the information content of a concept or an observable phenomenon, typically to retain only information which is relevant for a particular purpose. For example, abstracting a leather soccer ball to the more general idea of a ball retains only the information on general ball attributes and behavior, eliminating the characteristics of that particular ball.

First Principle

In philosophy, a **first principle** is a basic, foundational proposition or assumption that cannot be deduced from any other proposition or assumption. In mathematics, first principles are referred to as axioms or postulates. Gödel's incompleteness theorems have been taken to prove, among other things, that no system of axioms that describe the set of natural numbers can prove its own validity - nor perhaps can it prove every truth about the natural numbers.

There are two levels of abstraction which is desired to be achieved to have a stable software design of the system or problem under discussion.

i. External

ii. Internal

i. External Abstraction

In this type of abstraction we try to apply techniques and principles which help us to have a system which include a stable communication mechanism between the different components of the system, it will help the software architectures to transform complexity into structures to form the basic design component of the system.

Decomposition:

To achieve external abstraction rule of “**Divide and Conquer**” is usually applied so that the systems should be reduced to minimal information required to represent a system. We split one system into smaller components so that designing the components independently of each other can be achieved. For the outside world the components are reduced to their interfaces. We don't design components to correspond to execution steps since design decisions usually transcend execution time. We decompose so as to limit the effect of any one design decision on the rest of the system because anything that soaks the system will be expensive to change. Decomposition suggests that components should be specified by all information needed to use the component and nothing more! The rule of “**Keep it Simple**” is to be followed.

There are 3 different types of decomposition which are discussed as below:

I. Subsystems - Horizontal

II. Layers – Vertical

III. Tree – Tree Shaped

I. Subsystems – Horizontal Decomposition

“A Subsystem is a secondary or subordinate system within a system”

IEEE Standard 610.12-1990

This is most commonly used component to achieve external abstraction using decomposition. A subsystem is a functionally cohesive grouping of classes that is a major part of a larger aggregate system. They can be independently ordered, configured, or delivered and are related to each other via dependency relations, and communicate with each other via well-defined interfaces. The rule of thumb is to decompose a system by functional services i-e Database Subsystem, User Interface Subsystem etc; so that related services are combined under one component. We try to transform the set of requirement into a structured design in which there is no relationship of parent / child or master detail etc; subsystem basically defines the executable components typically represented by interfaces at implementation level for communication, the essence of the subsystem is that logically related requirements are combined under one component so that efficiency can be achieved as we move forward in software design process. Identifying subsystems usually involves backtracking, evaluation and revision of various solutions and it is important to get the decomposition right. The main advantage of subsystem is that it subsystems implemented by different teams depending upon components but this should be kept in mind that bad decomposition can lead to unworkable designs. The graphical representation of Subsystem is shown below:

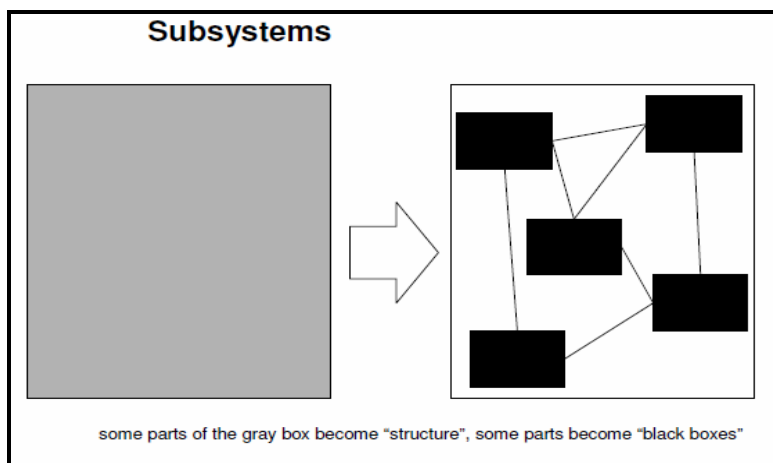

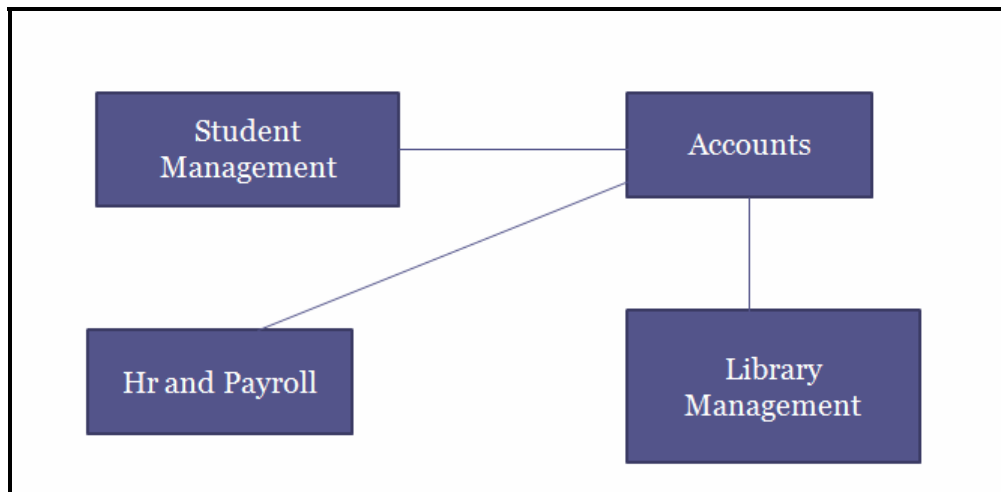
Sample Subsystem:**II. Layers – Vertical Decomposition**

Decomposition of the system into smaller, more manageable units, that are layered hierarchically. Each layer supplies one level of abstraction. A layer only uses services of the next underlying layer. A layer supplies services to the next top layer as each layer can be tested independently and can be substituted (machine independence). Layers help to structure applications that can be decomposed into groups of subtasks in which each group of subtasks is at a particular level of abstraction. Imagine that you are designing a system whose dominant characteristic is a mix of low- and high-level issues, where high-level operations rely on the lower-level ones. Some parts of the system handle low-level issues such as hardware traps, sensor input, reading bits from a file or electrical signals from a wire. At the other end of the spectrum there may be user-visible functionality such as the interface of a multi-user game or high-level policies such as telephone billing tariffs. A typical pattern of communication flow consists of requests moving from high to low level, and answers to requests, incoming data or notification about events traveling in the opposite direction. Such systems often also require some horizontal structuring that is orthogonal to their vertical subdivision. This is the case where several operations are on the same level of abstraction but are largely independent of each other.

- **OSI 7-layer model is a typical example of it.**

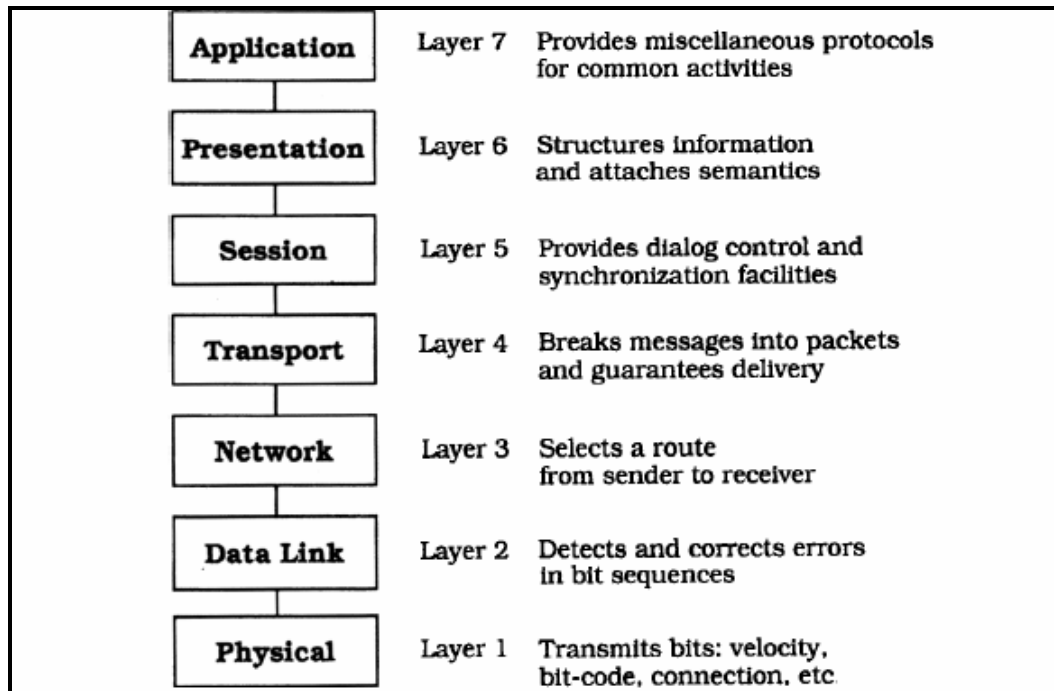

The system specification provided describes the high-level tasks to some extent, and specifies the target platform. Portability to other platforms is desired. Several external boundaries of the system are specified a priority such as a functional interface to which your system must adhere. The mapping of high-level tasks onto the platform is not straightforward mostly because they are too complex to be implemented directly using services provided by the platform. In such a case you need to balance the following forces:

- i. Late source code changes should not ripple through the system. They should be confined to one component and not affect others. Interfaces should be stable, and may even be prescribed by a standards body.
- ii. Parts of the system should be exchangeable. Components should be able to be replaced by alternative implementations without affecting the rest of the system. A low-level platform may be given but may be subject to change in the future. While such fundamental changes usually require code changes and recompilation, reconfiguration of the system can also be done at run-time using an administration interface. Adjusting cache or buffer sizes are examples of such a change. An extreme

form of exchangeability might be a client component dynamically switching to a different implementation of a service that may not have been available at start-up. Design for change in general is a major facilitator of graceful system evolution.

- iii. It may be necessary to build other systems at a later date with the same low-level issues as the system you are currently designing.
- iv. Similar responsibilities should be grouped to help understandability and maintainability. Each component should be coherent, if one component implements divergent issues its integrity may be lost. Grouping and coherence are conflicting at times.
- v. There is no 'standard' component granularity.
- vi. Complex components need further decomposition.
- vii. Crossing component boundaries may impede performance, for example when a substantial amount of data must be transferred over several boundaries, or where there are many boundaries to cross.

The system will be built by a team of programmers, and work has to be subdivided along clear boundaries and requirement that is often overlooked at the architectural design stage. Graphical representation of Layered Architecture is as below:

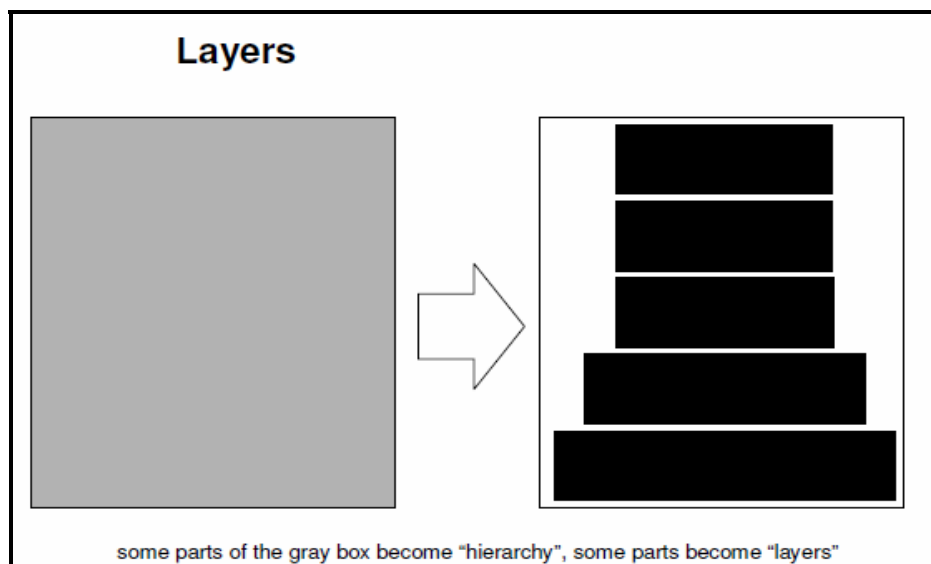

Layer Rule

From a high-level viewpoint the solution is extremely simple. Structure your system into an appropriate number of layers and place them on top of each other. Start at the lowest level of abstraction-call it Layer 1. This is the base of your system. Work your way up the abstraction ladder by putting Layer J on top of Layer $J - 1$ until you reach the top level of functionality-call it Layer N . Note that this does not prescribe the order in which to actually design layers, it just gives a conceptual view. It also does not prescribe whether an individual Layer J should be a complex subsystem that needs further decomposition, or whether it should just translate requests from Layer $J + 1$ to requests to Layer $J - 1$ and make little contribution of its own. It is however essential that within an individual layer all constituent components work at the same level of abstraction. Most of the services that Layer J provides are composed of services provided by Layer $J - 1$. In other words, the services of each layer implement a strategy for combining the services of the layer below in a meaningful way. In addition, Layer J 's services may depend on other services in Layer J . Layer J can request for services from exactly one layer below it and can respond to a request of a layer exactly one layer above it. The main structural characteristic of the Layers pattern is that the services of Layer J are only used by Layer $J + 1$ -there are no further direct dependencies between layers. This structure can be compared with a stack, or even an onion. Each individual layer shields its lower layers from direct access by higher layers.

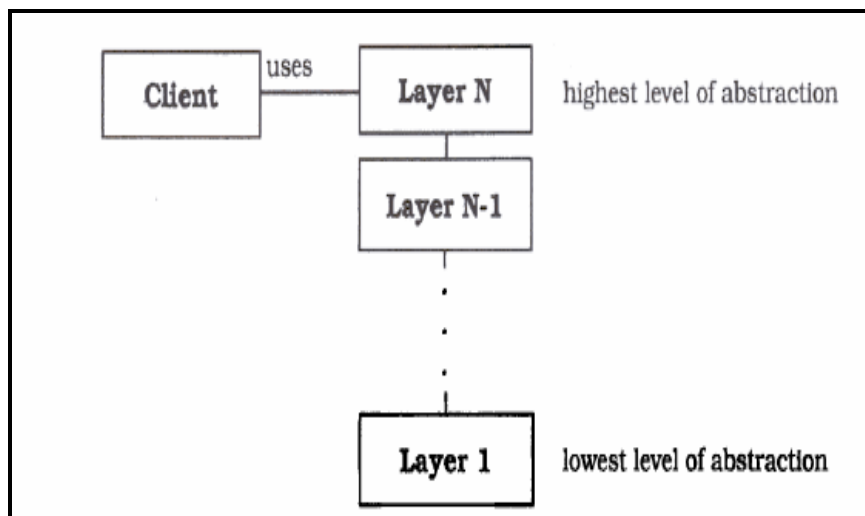

For example:

- **Total Layers = N = 3**
- **Legal Request = N-1**
- **Legal Response = N+ 1**

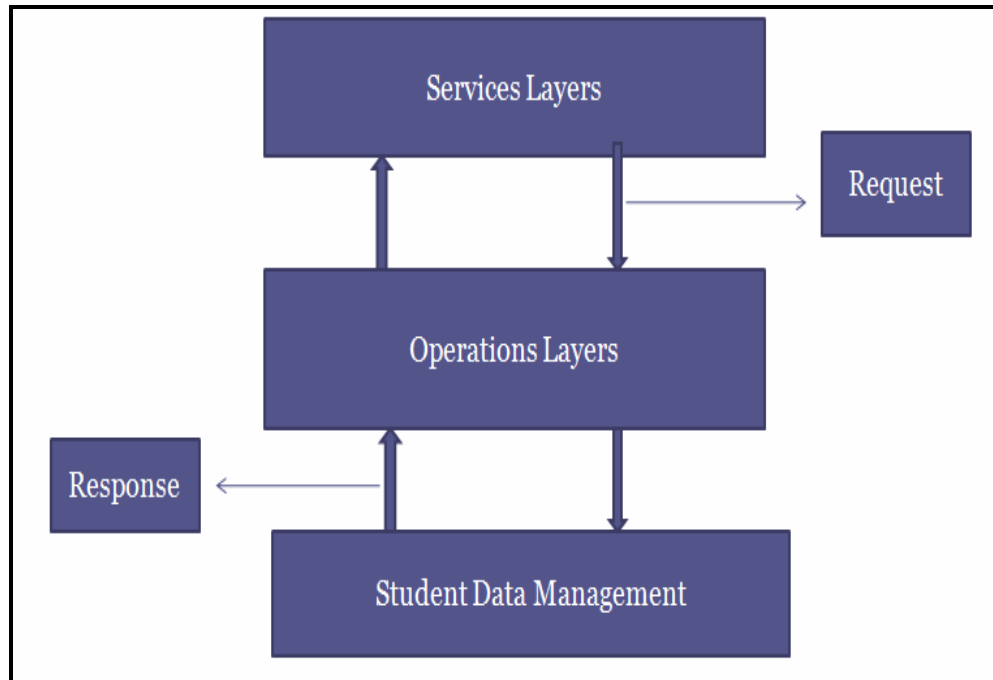

Dynamics:

The following scenarios are classic examples for the dynamic behavior of layered applications. This does not mean that you will encounter every scenario in every architecture. In simple layered architectures you will only see the first scenario, but most layered applications involve Scenarios I and II. Due to space limitations we do not give object message sequence charts in this pattern.

Scenario I is probably the best-known one. A client issues a request to Layer N. Since Layer N cannot carry out the request on its own, it calls the next Layer N -1 for supporting subtasks. Layer N -1 provides these, in the process sending further requests to Layer N -2, and so on until Layer 1 is reached. Here, the lowest-level services are finally performed. If necessary, replies to the different requests are passed back up from Layer 1. A characteristic of such top-down communication is that Layer J often translates a single request from Layer J+ 1 into several

requests to Layer J -1. This is due to the fact that Layer J is on a higher level of abstraction than Layer J-1 and has to map a high-level service onto more primitive ones.

Scenario II illustrates bottom-up communication—a chain of actions starts at Layer 1, for example when a device driver detects input. The driver translates the input into an internal format and reports it to Layer 2, which starts interpreting it, and so on. In this way data moves up through the layers until it arrives at the highest layer. While top-down information and control flow are often described as 'requests', bottom-up calls can be termed 'notifications'. As mentioned in Scenario I, one top-down request often fans out to several requests in lower layers. In contrast, several bottom-up notifications may either be condensed into a single notification higher in the structure, or remain in a 1: 1 relationship.

Scenario III describes the situation where requests only travel through a subset of the layers. A top-level request may only go to the next lower level N -1 if this level can satisfy the request. An example of this is where level N -1 acts as a cache and a request from level N can be satisfied without being sent all the way down to Layer 1 and from here to a remote server. Note that such caching layers maintain state information, while layers that only forward requests are often stateless. Stateless layers usually have the advantage of being simpler to program, particularly with respect to reentrancy.

Scenario IV describes a situation similar to Scenario III. An event is detected in Layer 1, but stops at Layer 3 instead of traveling all the way up to Layer N. In a communication protocol, for example, a resend request may arrive from an impatient client who requested data some time ago. In the meantime the server has already sent the answer, and the answer and the re-send request cross. In this case, Layer 3 of the server side may notice this and intercept the re-send request without further action.

Scenario V involves two stacks of N layers communicating with each other. This scenario is well-known from communication protocols where the stacks are known as 'protocol stacks'. In the following diagram, Layer N of the left stack issues a request. The request moves down through the layers until it reaches Layer 1, is sent to Layer 1 of the right stack, and there moves up through the layers of the right stack. The response to the request follows the reverse path until it arrives at Layer N of the left stack.

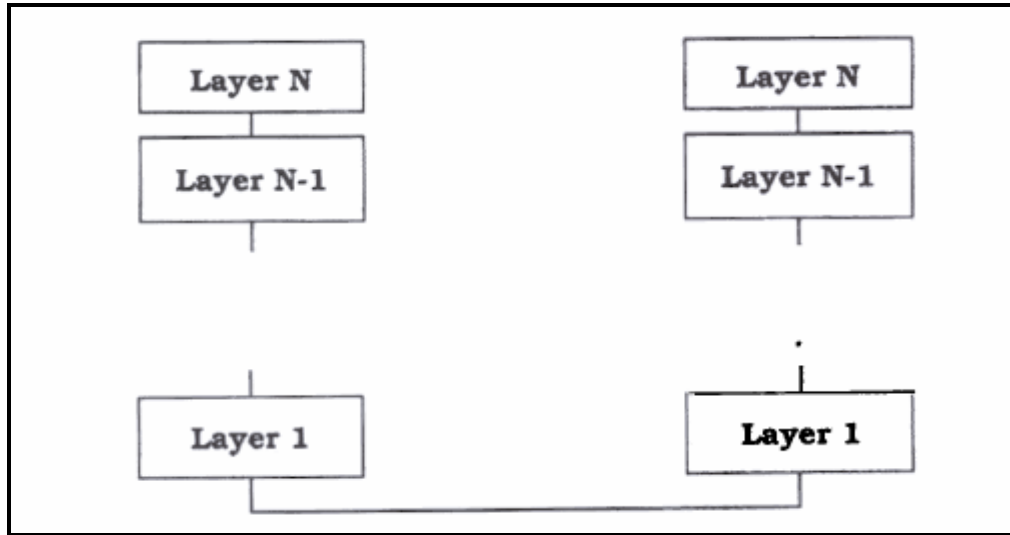

III. Tree-Structures – Tree Shaped Decomposition

This is a hybrid decomposition which is a combination of subsystem and layers in which we can start at the root node and each node can be reached in exactly one way. This type of decomposition follows a tree structure in which there is always one fixed starting point as opposed to subsystems in which there was no fixed starting point; and each root node can have either a child node or leaf node (terminal node). Usually the nodes can be placed in different layers a node can be considered as the representative of his sub tree. This is a bit tricky decomposition because decision to opt for this is not very clear because we need to identify the need for it by critically analyzing the requirement because some portion of the requirements will be converted into subsystems and subsystems will be placed in different layers but subsystems in the layers will communicate to components of subsystems of next layer, what we need to understand is that it will have properties of layers and subsystems in it as shown graphically below:

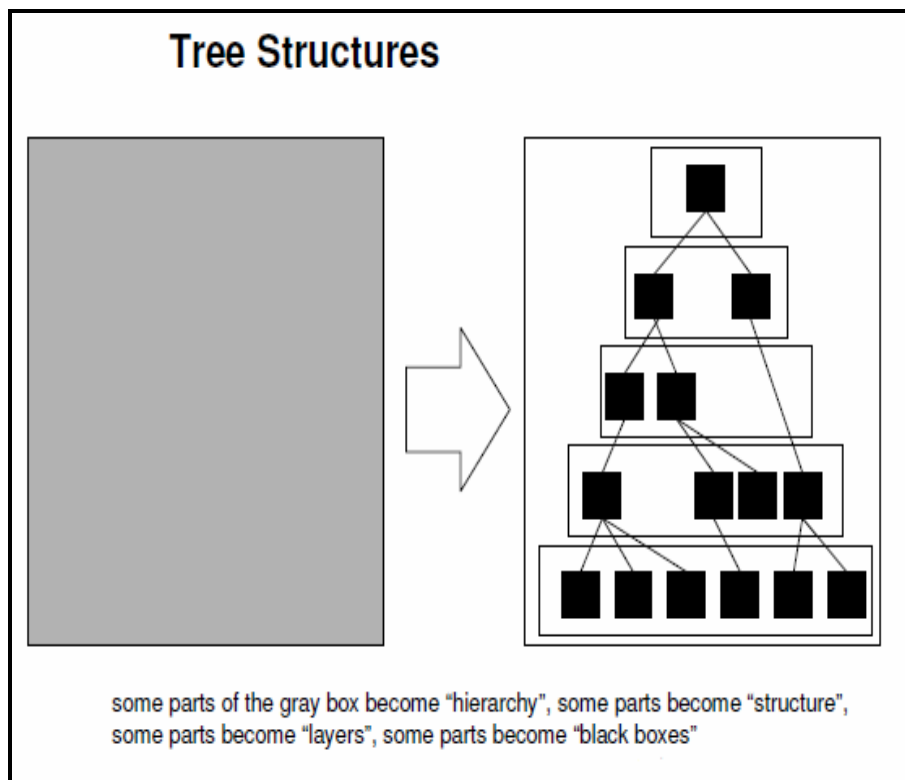

Problem Statement:

An automated ticket issuing system is used by passengers at a railway station for multiple purposes. The System should also allow reservation of seats and give some route information. The passenger should be able to pay for the ticket at the counter also.

To Do Task: We have to design the architecture of the above system after selecting a specific principle and proper assumptions.

Possible Solution: Subsystem

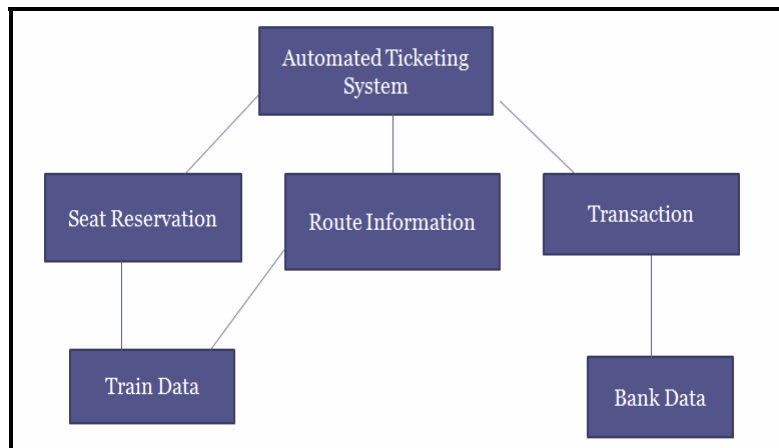

Possible Solution: Layered Architecture

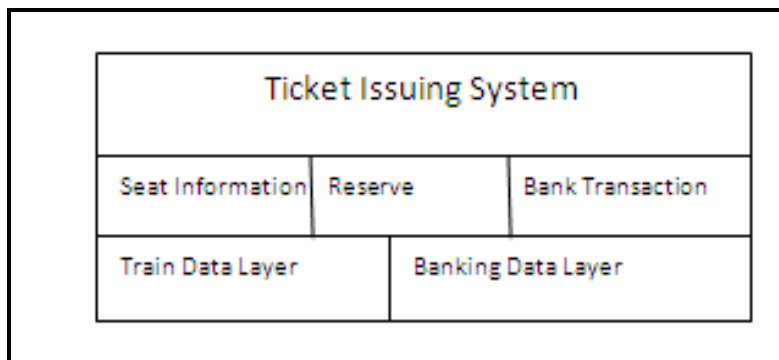

ii. Internal Abstraction:

a. Modularization

Software architecture embodies modularity; that is, software is divided into separately named and addressable components, often called *modules* that are integrated to satisfy problem requirements. It has been stated that "modularity is the single attribute of software that allows a program to be intellectually manageable". Monolithic software (i.e., a large program composed of a single module) cannot be easily grasped by a reader.

Modularization Defined:

“The process of breaking a system into components to facilitate design and development; an element of modular programming”

This is very common and basic rule of programming and software design in which we break the software requirements in such a way that the components can be identified so to promote reusability and to localize the error. We need to achieve modularity because this will provide us with the facility of identifying and rectifying the error without looking in the whole software design / code rather we will look into a particular module to fix it. In software design, **modular design** — or "modularity in design" — is an approach that subdivides a system into smaller parts (modules) that can be independently created and then used in different systems to drive multiple functionalities. A modular system can be characterized by the following:

- "(1) Functional partitioning into discrete scalable, reusable modules consisting of isolated, self-contained functional elements;
- (2) Rigorous use of well-defined modular interfaces, including object-oriented descriptions of module functionality;
- (3) Ease of change to achieve technology transparency and, to the extent possible, make use of industry standards for key interfaces."

Besides reduction in cost (due to lesser customization, and less learning time), and flexibility in design, modularity offers other benefits such as augmentation (adding new solution by

merely plugging in a new module), and exclusion. Examples of modular systems are cars, computers and high rise buildings. Earlier examples include railroad signaling systems, telephone exchanges, pipe organs and electric power distribution systems. Computers use modularity to overcome changing customer demands and to make the manufacturing process more adaptive to change. Modular design is an attempt to combine the advantages of standardization (high volume normally equals low manufacturing costs) with those of customization. A downside to modularity (and this depends on the extent of modularity) is that modular systems are not optimized for performance. This is usually due to the cost of putting up interfaces between modules

i. Encapsulation

“A view of a problem that extracts the essential information relevant to a particular purpose and ignores the remainder of the information”

[IEEE, 1983]

Encapsulation is the grouping of related ideas into one unit, which can thereafter be referred to by a single name. This is achieved by isolating a system function or a set of data and operations on those data within a module by providing precise specifications for the modules. Common elements of an abstraction are grouped together and separated from other components; e.g. an Abstract Data Type.

Example – I

Simple digital alarm clock is a real-world object that a layman can use and understand. They can understand what the alarm clock does, and how to use it through the provided interface (buttons and screen), without having to understand every part inside of the clock. Similarly, if you replaced the clock with non-digital model, the layman could continue to use it in the same way, provided that the interface works the same.

Example –II

A relational database is encapsulated in the sense that its only public interface is a Query language (SQL for example), which hides all the internal machinery and data structures of the database management system.

ii. Information Hiding – It is not Encapsulation:

The concept of modularity leads every software designer to a fundamental question: "How do we decompose a software solution to obtain the best set of modules?"

The principle of *information hiding* suggests that modules be "characterized by design decisions that (each) hides from all others." In other words, modules should be specified and designed so that information (procedure and data) contained within a module is inaccessible to other modules that have no need for such information. Hiding implies that effective modularity can be achieved by defining a set of independent modules that communicate with one another only that information necessary to achieve software function. Abstraction helps to define the procedural (or informational) entities that make up the software. Hiding defines and enforces access constraints to both procedural detail within a module and any local data structure used by the module. The use of information hiding as a design criterion for modular systems provides the greatest benefits when modifications are required during testing and later, during software maintenance. Because most data and procedure are hidden from other parts of the software, inadvertent errors introduced during modification are less likely to propagate to other locations within the software.

Information Hiding is software design technique to achieve internal abstraction using modularization in which each module's interfaces reveal as little as possible about the module's inner workings and other modules are prevented from using information about the module that is not in the module's interface specification. Every module is characterized by its knowledge of a design decision which it hides from all others. Its interface or definition was chosen to reveal as little as possible about its inner workings. Information hiding gives the designer the freedom to *modify* how the responsibility is fulfilled by a module/object. This is helpful when design decisions are likely to change. Design decisions that are subject to change should be hidden behind abstract interfaces. Components should communicate only through well-defined interfaces. Each component is specified by as little information as possible. If internal details change, client components should be minimally affected (it may not even require recompilation).

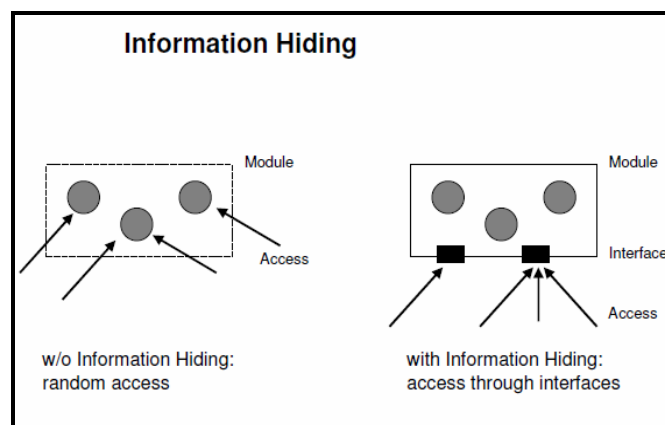

LECTURE NO: 8 and 9

Objective:

This chapter will cover related concepts of lecture 8 and 9. We will start our discussion on criteria **component** of the software design and will be discussing different criteria's of software design excluding cohesion and extensible.

Software Design Criteria:

When we design a software design, we need to understand the criteria beside principles which should be followed to achieve a good software design. As shown in the diagram below Criteria and Techniques are software design components which we will be discussing.

i. Complete

This software design criteria refer to the view that each component has all relevant features within the abstraction; a general interface can be reused.

ii. Sufficient

Each component has all the features needed for a sensible and efficient usage within the abstraction. The interface is as small as possible. Minimum possible interface is to be selected

iii. Plausible

The decomposition of modules can be easily and intuitively be understood. Complexity is not a criterion for a good software design.

iv. Homogeneous:

All the layers / subsystems should focus in same problem set. A minimal set of required information should be included; the principle of information hiding is to be implemented

Example:

- While calculating the annual interest on savings bank should not include details about customer Education!!!

v. Focused

Separation of concerns Principle (SOC)

When designing software, there are usually certain requirements or considerations to be carried out so that the software comes up to the expectations placed on it. These requirements or considerations are called **concerns**. As an example of different concerns, a CRM system may have concerns such as managing customers and their contacts, managing events, persistence of data, reporting, security, logging, comprehensibility, maintainability and integration to existing systems. Some of the concerns will be implemented as simple business logic; others may be related with the quality of the software.

Type of Concerns:

If we think of our CRM system, concerns such as managing customers, their contacts and events are the core functionality of the system. They are called **core concerns**. In object oriented systems, the core concerns can be separated of each other in their respective objects. On the other hand, concerns like security and logging span multiple objects. Logging has to be done in methods all over the system. These concerns that crosscut multiple modules are called **crosscutting concerns**. In object-oriented systems, crosscutting concerns break the separation of concerns: the crosscutting concerns cannot be studied in isolation of other concerns, and while studying core concerns the crosscutting concerns are always present.

There may be tight coupling between core concerns and crosscutting concerns. One of the symptoms of the tight coupling is that if there is a change in some crosscutting concern, many little changes have to be made to many objects. This is because the crosscutting concern is scattered in multiple core modules. There are two kinds of code scattering, duplicating and complementary scattering. In duplicating scattering, identical piece of code is added to many different modules. In complementary scattering, several modules implement complementary parts of the concern. In addition to code scattering, when a module handles multiple concerns simultaneously, code tangling arises. The nature of crosscutting concerns is inherent. Crosscutting concerns cannot be handled well with an object-oriented language, not even by improving the design. Object-oriented programming is just not sufficient for managing crosscutting concerns

SOC is a general principle in software engineering introduced by Dijkstra and Parnas as an answer to control the complexity of ever-growing programs. In a nutshell, it promotes the separation of different interests in a problem, solving them separately without requiring detailed knowledge of the other parts, and finally combining them into one result. In practice, this

principle actually corresponds with finding the right decomposition or modularization of a problem. Hereby, allowing for the modules to be expressed in different representations (even within the same application) might help to facilitate their solution. Over the years, the quest for better and more advanced representations has led to different technologies, among which the well-established modularization techniques such as functional decomposition and object-orientation. While the principle formerly typically served to structure the functionality of programs, it has lately also been applied to separate functional and nonfunctional requirements. Examples of such non-functional requirements are distribution, fault-tolerance and security. Such concerns are often hard to factor out in separate modules using classical object oriented techniques. The code responsible for fault-tolerant behavior for instance is not well-separated in one class or method, but cuts across many classes and methods. To separate such crosscutting concerns, new separation or modularization techniques are necessary. This principle is recognition of the need for human beings to work within a limited context. As described by G. A. Miller the human mind is limited to dealing with approximately seven units of data at a time. A unit is something that a person has learned to deal with as a whole - a single abstraction or concept. Although human capacity for forming abstractions appears to be unlimited, it takes time and repetitive use for an abstraction to become a useful tool; that is, to serve as a unit. When specifying the behavior of a data structure component, there are often two concerns that need to be dealt with: **basic functionality and support for data integrity**. A data structure component is often easier to use if these two concerns are divided as much as possible into separate sets of client functions. It is certainly helpful to clients if the client documentation treats the two concerns separately. Further, implementation documentation and algorithm descriptions can profit from separate treatment of basic algorithms and modifications for data integrity and exception handling. There is another reason for the importance of separation of concerns. Software engineers must deal with complex values in attempting to optimize the quality of a product. From the study of algorithmic complexity, we can learn an important lesson. There are often efficient algorithms for optimizing a single measurable quantity, but problems requiring optimization of a combination of quantities are almost always NP-complete. Although it is not a proven fact, most experts in complexity theory believe that NP-complete problems cannot be solved by algorithms that run in polynomial time. In view of this, it makes sense to separate handling of different values. This can be done either by dealing with different values at different times in the software development process, or by structuring the design so that responsibility for achieving different values is assigned to different components.

.Applying SOC principle:

Applying the principle of separation of concerns to software design can result in a number of residual benefits. First, the lack of duplication and singularity of purpose of the individual

components render the overall system easier to maintain. Second, the system as a whole becomes more stable as a byproduct of the increased maintainability. Third, the strategies required to ensure each component only concerns itself with a single set of cohesive responsibilities often result in natural extensibility points. Fourth, the decoupling which results from requiring components to focus on a single purpose leads to components which are more easily reused in other systems, or different contexts within the same system. Fifth, the increase in maintainability and extensibility can have a major impact on the marketability and adoption rate of the system. The principle of separation of concerns can also be of benefit when applied to business organizations. Within large companies, ensuring that groups and sub-organizations are assigned a unique set of cohesive responsibilities helps to facilitate overall business goals by minimizing the coordination necessary between teams and maximizing the potential of each team to focus on their collective responsibility and center of competency. The principle of separation of concerns can also improve problem resolution in enterprise wide systems. When responsibilities are properly delineated, problem identification becomes easier, resolution becomes faster, and personal accountability is increased. Each of these areas in turn contributes to an improved quality control process. Whether organizations of people or software systems are in view, applying the principle of separation of concerns can aid in the management of complexity by eliminating unnecessary duplication and proper responsibility allocation.

Example:

i. Web Content Management

There are number of classes, html pages, and css files grouped as a presentation layer concern, then those classes, files, etc should only change for UI reasons and never need to change for other concerns such as a change in databases. On a more granular level within the presentation layer, you could separate content, format, and style concerns by grouping them into resource, html, and css files.

- ii. If you have a class that gets a person's name from the database and arranges the order of the first, last, and middle names, then there are two reasons to change this component. You would need to change the class to change how it got data from the database and you would need to change the class to change the order of the names. If you separated these two purposes into a data access class that fetched the data and a presentation class that arranged the name order,

vi. Coupling / Cohesion

Coupling - Degree of dependence among components

Coupling refers to how many dependencies there are between modules and the nature of the links. A module which is highly coupled means that it has to use many other modules for its own functionality to work. A highly coupled module is difficult to test on its own and since it uses many other modules, there are interfaces between them which increases the likelihood of defects

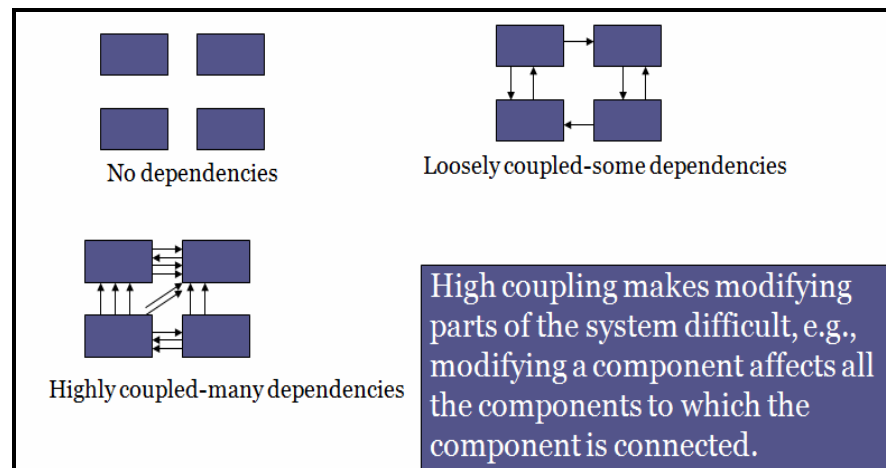

Desired Coupling

The Components should **“Loosely Coupled”**. Loose Coupling promotes **“Separation of concern”**. Loose coupling means designing so that you hold connections among different parts of a program to a minimum. This means encapsulation, information hiding and good abstractions in class interfaces. This also makes the stuff easier to test, which is a Good Thing. Coupling is easier to measure and understand, because it is more mechanical in nature and requires less interpretation. Suppose there are three components A, B, and C. A’s behavior depends upon B in some way (any way), A’s behavior depends upon C in some way, and the behavior of B and C do not appear to depend upon anything else. That’s pretty much it, that’s the coupling of the system according to our definition, and it’s the sort of thing that a machine can figure out by simple measurement as shown in the diagram below:

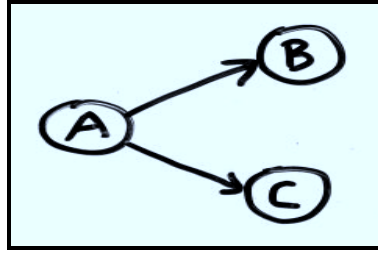

Dependencies

If module A requires module B before it can be tested, but module B also requires module C, we might think that developing C first is the answer. Often though, these dependencies are interrelated so perhaps C also requires elements of A. For this reason, designing the modules can be complex and requires us to think about how the modules are related together. We want to reduce the dependencies but not at the expense of reproducing the functionality in two or more places. For example, if there are 2 components A and B; and both of them need to access a database, it would be sensible to put the functionality to handle a database in a single module and allow A and B to use it, rather than building in that functionality to both A and B.

Level of Coupling:

Level of coupling refers to depth of dependency between components, we can estimate the level of coupling for a set of modules by considering each of the "kinds" of coupling listed below, one at a time. It's not important that you determine the precise level of coupling for a given set of modules - but it *is* important to decide whether this is "unacceptably high," "high but unavoidable," "acceptable," or "ideal."

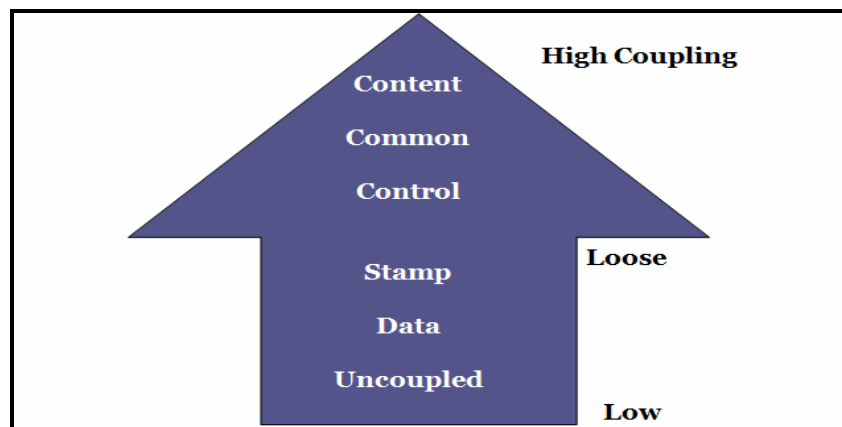

i. Content Coupling

This is highest level of coupling and occurs if there are two (or more) modules and if one refers to the **``inside'' - the ``internal'' or ``private'' part** - of the other in some way.

- i. Module A **``branches''** or **``falls through''** into Module B (by containing a GOTO statement that transfers control somewhere into the middle of Module B);
- ii. Module A refers to, or changes, Module B's internal (and, again, **``private''**) data
- iii. Module A changes one of the statements in Module B's object code.

This is also known as **``Pathological Coupling''** - and it could said with some justification that the above examples do involve **``sick programming practices.**" Fortunately, high level programming languages make these difficult - though you can certainly do these things using assembly languages (or C). Optimization" is sometimes cited as an excuse for these. This is the *only* plausible excuse for these that one might think of - you might consider resorting to some of these only after every other sensible strategy has failed to produce a program that meets the system's performance requirements (long after you've re-implemented critical sections, used hardware components instead of software where possible, etc.) However, optimization is often unnecessary, and there are less troublesome things you can do to improve program efficiency. Since the above practices make proper testing difficult, and program maintenance almost impossible, programming practices that introduce **``content coupling''** should be regarded as a last resort (and ideally, never be used).

Example:

If there is a software program and part of program handles lookup for customer based on the data provided by the client. One component (function or method) is handling data lookup feature and another component is handling the property of adding new customer as of when needed. In new customer component data structure is processed in which data is stored of the new customer.

- When we are searching the customer data and customer is not found, lookup component adds customer by directly modifying the contents of the data structure containing customer data (new customer). This is a very high level of coupling in which one component is directly modifying the content of another component and this is not wanted in any software design.

Improvement:

When customer not found, component calls the AddCustomer () method that is responsible for maintaining customer data rather than directly modifying data structure.

ii. Common Coupling

Common coupling occurs when modules communicate using global data areas (i.e., universal common data areas). For example, programming allows the developer to declare a data element as external, enabling it to be accessed by all modules. Common coupling is also known as “**Global coupling**”. We can say that two components share data using **Global data structures** and **Common blocks**.

Example:

Process control component maintains current data about state of operation. It gets data from multiple sources and then supplies data to multiple sink. Each source process writes directly to global data store. Each sink process reads directly from global data store. The diagrammatic representation is as below:

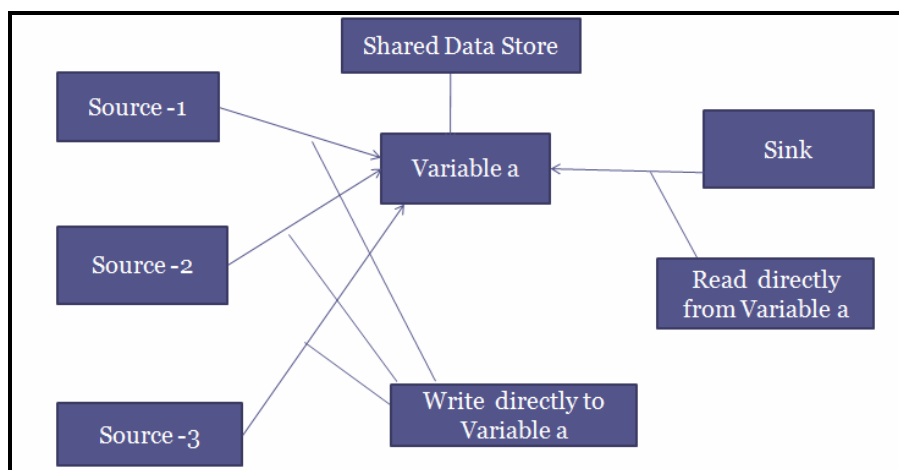

In the above scenario there can be a situation where sink might see the inconsistent value of **variable a**, if one source is writing the value of variable a and sink read it and while sink is reading the values another source may change it so it implies that sink is having inconsistent value of shared variable a. We want to avoid such a situation so that sink should have consistent value of variable a

An improvement is suggested to reduce the level of coupling that exists between the components, due to high level of coupling that is a danger of inconsistent data in the application. The improved solution suggest that there should a component responsible for reading the value of the shared variable, rather than any component directly reading the value of shared variable and it will be the responsibility of the data manager to maintain the consistent view of the shared variable. The suggested solution is shown below:

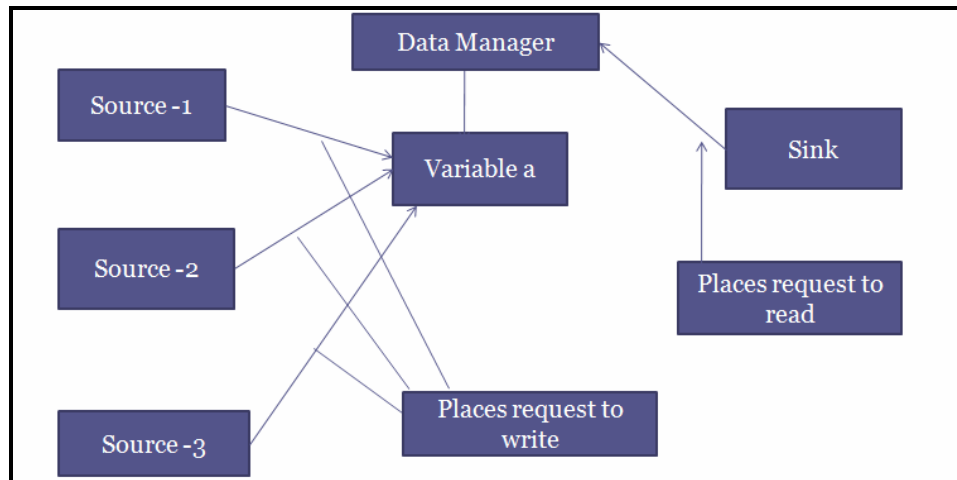

iii. Control Coupling – Moderate Coupling

Two modules exhibit *control coupling* if one ("module A") passes to the other ("module B") a piece of information that is intended to control the internal logic of the other. This will often be a value used in a test for a case statement, if-then statement, or while loop, in module B's source code. This is perfectly acceptable. However, the program architecture (as shown by the structure chart) should make it clear that module A *does* control module B in this way - preferably by having module A call module B directly, or vice-versa. Then, when the system is combined together ("integrated") and tested, the two modules will be combined together, and tested as one unit, relatively early in the process - so that any problems arising from this control coupling" will be detected early on. This may be either good or bad, depending on situation. It is bad when component must be aware of internal structure and logic of another module and it is good if parameters allow factoring and reuse of functionality.

Example of Control Coupling

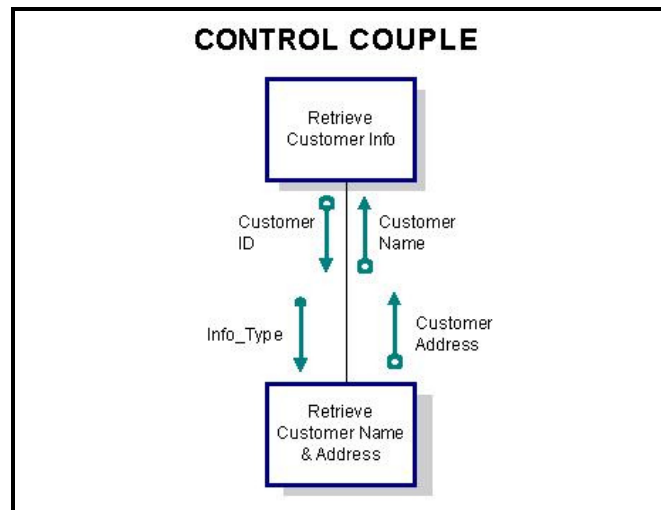

In an example of control coupling, a module that retrieves either a customer name or an address depending on the value of a flag is illustrated. As a rule of thumb, use descriptive flags (i.e., a flag that describes a situation or condition, such as end-of-file or invalid-acct-num). Do not use control flags (i.e., a flag that tells a module what to do, such as write-err-message).

iv. Stamp Coupling – Low Level Coupling

Stamp coupling is when modules share a composite data structure and use only a part of it, possibly a different part (e.g., passing a whole record to a function that only needs one field of it)

OR Two modules ("A" and "B") exhibit *stamp coupling* if one passes directly to the other a "composite" piece of data - that is, a piece of data with meaningful internal structure - such as a record (or structure), array, or (pointer to) a list or tree.

Example -1

The print routine of the customer billing accepts a customer data structure (cid, customer name, address, phone no, email address, NIC, cell no, passport no) as an argument, parses it, and prints the **name, address, and billing amount**. The billing amount is retrieved on the basis of cid which is passed as an argument in the module. Only cid, customer name and address is used other attributes are not used or in other word they are not needed.

Improvement

The print routine takes the customer name, address, and billing information as an argument rather than taking the whole structure as input.

Example –II

An example of stamp coupling illustrates a module that retrieves customer address using only customer id which is extracted from a parameter named customer details.

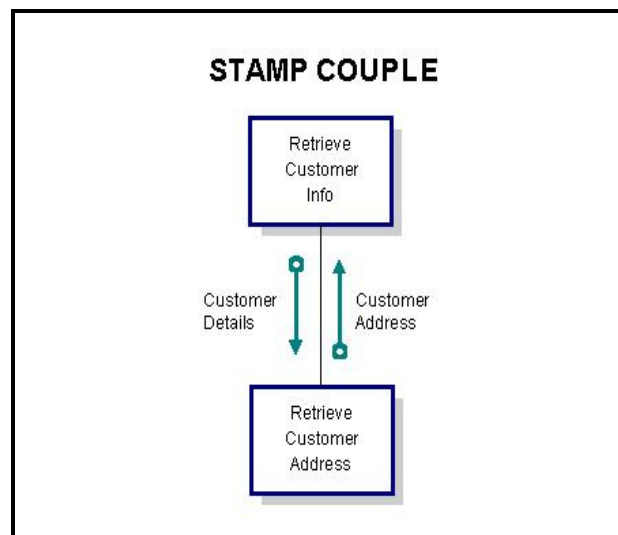

As a rule of thumb, never pass a data structure containing many fields to a module that only needs a few. Some of the practitioners of structured design do not make a distinction between the passing of parameters in an unstructured format (as described under data coupling) and the passing of parameters in a data structure (stamp coupling). The distinction between data and stamp coupling is not relevant in object-oriented systems. Stamp coupling promotes the creation of artificial data structures (i.e., bundling of unrelated data elements together in a structure). Although this bundling is meant to reduce coupling between modules, it in fact increases the coupling between modules. Data structures are appropriate as long as the data bundled together is meaningful and related.

v. Data Coupling – Low Level of Coupling

Data coupling occurs between two modules when data are passed by parameters using a simple argument list and every item in the list is used.

OR

Two modules exhibit *data coupling* if one calls the other directly and they communicate using "parameters" - a simple list of inputs and outputs (and inputs that are modified) --- with each parameter being an "elementary" piece of data, such as an integer, floating point number, boolean value, member of an enumerated set, character, or (maybe) character string. The modules exhibit stamp coupling if "composite" data types are used for parameters as well. Ideally, this ("data coupling") is the usual type of interaction between modules that need to communicate at all: Modules with higher levels of coupling this are only used "when necessary." A module sees only the data elements it requires. It is the best (i.e., loosest) form of coupling.

Example:

An example of data coupling is illustrated as a module which retrieves customer address using customer id and only customer id is passed as an argument in the retrieve customer address module. There is no extra attributes passed to the customer address module.

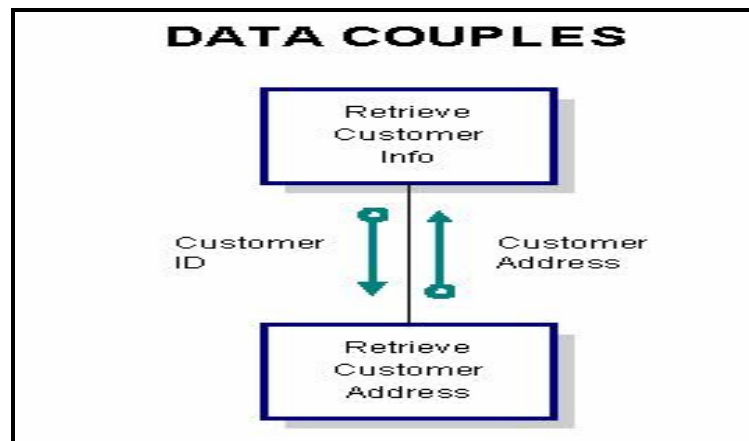

A module can be difficult to maintain if many data elements are passed. Too many parameters can also indicate that a module has been poorly partitioned.

LECTURE 10 and 11

Objectives:

In this chapter we will continue our discussion on design criteria and will be discussion concept of cohesion in detail along with other software design criteria's.

Cohesion:

Principle of cohesion states that

“Things that belong together should be kept together”.

OR

“A measure of the closeness of the relationships between elements of a component or "module" of a system”

The classic software design involves grouping data and the functions that act on it. We can understand cohesion as a measure of how exclusively a methods interact with its data and how exclusively the data is used by its methods. Cohesion has been extremely violated when a method does not use any of the own data, when a method contains data that is not used by its own functional elements, or when we have a function that deals only with the data of some other method. Less egregious violations are common, where a function deals with some of its object's data but deals also with the data or functions exposed by another object. Lack of cohesion can also be apparent from an **external perspective**: If you find that approaching any system behavior via one path (command, screen, or web page) produces different results than approaching the same behavior from a different path, you've been bitten by duplication as an effect of poor cohesion. Good cohesion makes it possible to find functions easily. If methods dealing with an address are located in the Address class, someone working with an address can easily find the method they need and call it, instead of re-implementing it from scratch. If functions that deal with an address are buried inside a mail-authoring component, a programmer working outside of that component is unlikely to find them. He may end up rewriting the needed behavior into the function he is working on so that afterward it is *still* not in the Address class. Later his coworkers will re-implement it again. Without cohesion, duplication propagates. Cohesion describes the focus of an individual software component. When a component has only

one responsibility, and therefore only one reason to change, then it has high cohesion. When a component has many responsibilities, and therefore many reasons to change, then it has low cohesion. Low cohesion is also noticeable when common responsibilities are spread throughout unrelated components.

Desired Cohesion:

From software design view point always **“High cohesion”** is desirable because: it simplifies correction, change and extension process. Components with high cohesion are more robust than components with low cohesion. If a component representing an engine is responsible for both accelerating and decelerating, then a change to the acceleration implementation could inadvertently effect the deceleration implementation. If, however, the engine component is responsible for acceleration and a separate brake component is responsible for deceleration, then a change to the acceleration implementation in the engine component is unlikely to effect the deceleration implementation in the brake component. Maintaining highly cohesive components is easy. If all the logic dealing with deceleration is in the brake component, and that logic is not spread throughout your system, then you won’t have to go hunting around your system whenever you make changes to the deceleration logic. You only need to look at your break component. Hence it simply reduces testing and it localizes the error to be detected easy as compared to low cohesion.

Level or Range of Cohesion

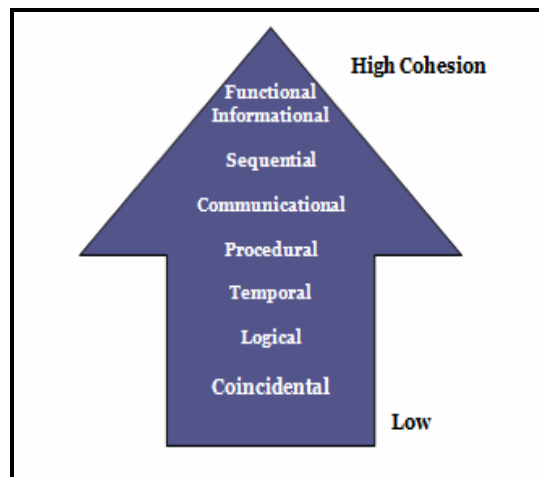

i. Coincidental Cohesion – Lowest Cohesion

Modules with ``low'' levels of cohesion are highly undesirable and should be modified or replaced. Coincidental cohesion occurs when parts of the component are only related by their location in source code. A coincidentally cohesive module is one whose activities have no meaningful relationship to one another. Coincidental cohesion is considered the **worst level of cohesion**. Its activities are not related by flow of data or by flow of control. It is even less cohesive than a logically cohesive module because its activities are not even in the same category. Coincidental cohesion is very difficult to maintain. It requires the programmer to know the internal details of the modules.

Example-I:

There is a mythological story associated with coincidental cohesion, a manager who is responsible for maintaining a largish (say, 10000 line of code) C program reads about modularity and how helpful it is in improving programming understanding of programs. The manager tells his chief programmer to restructure the program (which is a one large subprogram) into modules. He's going to get those benefits. The chief programmer, who thinks he has better uses for his time, decides the fastest way to make modules out of the program is to take a ruler, measure down every **6 inches** in the program listing and draw a line. At each line, he inserts a call to a new subprogram, and after that call creates the header for the new subprogram. These **"modules"** exhibit ultimate coincidental cohesion because the line of code in the module is present mere due to by incidence not by any logic or rule.

Example – II

Suppose we have a module with multiple arguments, the module is performing the following processing:

- i. Print next line
- ii. Reverse string of characters in second argument
- iii. Add 7 to 5th argument
- iv. Convert 4th argument to float

→ **All the above functions have no relationship but they are there in the same module by chance!!**

ii. Logical Cohesion

In this level of cohesion elements of component are related logically and not functionally. Several logically related elements are in the same component and one of the elements is selected by the client component. A logically cohesive module performs several activities of the same general category in which the activity or activities to be executed are selected by the invoking module.

“A *logically cohesive* module is one whose elements contribute to activities of the same general category in which the activity or activities to be executed are selected from outside the module.”

A logically cohesive module contains a number of activities of the same general kind. To use the module, we pick out just the piece(s) we need. Thus, a logically cohesive module is a grab bag of activities. The activities, although different, are forced to share the one and only interface to the module. The meaning of each parameter depends on which activity is being used; for certain activities, some of the parameters will even be left blank (although the calling module still needs to use them and to know their specific types).”

Example –I

Someone contemplating a journey might compile the following list:

- a. Go by Car
- b. Go by Train
- c. Go by Boat
- d. Go by Plane

What relates these activities? They're all means of transport, of course. But a crucial point is that for any journey, a person must choose a specific subset of these modes of transport. It's unlikely anyone would use them *all* on any particular journey.

Example- II

In performing an I/O operation a component reads inputs from tape, disk, and network. All the code for these functions is in the same component. It is to note that operations are related, but the functions are significantly different i-e the way to execute each function is different by the different ways of performing I/O belong to same category that's why they are in same module.

iii. TEMPORAL COHESION

A temporally cohesive module is one which performs several activities that are related in time. Temporally cohesive modules typically consist of partial activities whose only relationship to one another is that they are all carried out at a specific time. A *temporally cohesive* module is one supporting tasks that are all related in time. Often the activities in a temporally cohesive module are more closely related to other modules than they are to each other. This type of cohesion also results in tight coupling of data. It makes maintenance of a system more difficult. For example, if a module requires only one piece of data to be initialized, it cannot call the global initialization routine because that would reset data for the entire system. Instead, the developer has to decide whether to remove the initialization code for the data it wants initialized to create a separate initialization routine or to pass a parameter to the initialization routine indicating the piece of data that is to be initialized. In either case, the existing code that invokes the initialization routine must be modified. A better approach would have been to separate the temporally cohesive initialization routine into functionally cohesive modules that initialize related data. Maintenance is made more difficult because often the developer is tempted to share code among activities within the module that are only related in time. As with procedurally cohesive modules, changes made to one activity may affect another activity and it is more difficult to re-use a temporally cohesive module.

Example – I

Consider a module called "**On_Really_Bad_Failure**" that is invoked when a **Really_Bad_Failure** happens. The module performs several tasks that are not functionally similar or logically related, but all tasks need to happen at the moment when the failure occurs. The module might

- i. Cancel all outstanding requests for services
- ii. Cut power to all assembly line machines
- iii. Notify the operator console of the failure
- iv. Make an entry in a database of failure records

Example -II

One of the most common examples of a temporally cohesive module is an initialization routine that initializes data used by many modules throughout a system. All the parameter which require

initialization are set to their starting values irrespective of their functional relationship but due to the fact they are related in term of time in which they should get initialized, they are knitted together.

iv. Procedural Cohesion

Elements of a component are related only to ensure a particular order of execution. Module with (only) procedural cohesion is one supporting different and possibly unrelated activities, in which control passes from one activity to the next. In this type of cohesion the elements are arranged together in the module but with a condition that there is particular sequence to be followed to execute them. Activities in a procedurally cohesive module are related by flow of execution rather than by one problem-related function. They often contain a group of functions which make up part of a larger function, but as a group perform no real function. Procedural cohesion may result from an attempt to modularize some part of a flow chart. It is common in a procedurally cohesive module for the input and output data to be unrelated. It is also common for such a module to pass around partially edited data, switches, or flags. Because a procedurally cohesive module performs no real function in itself, it is generally not a black box and not re-usable. Procedurally cohesive modules are not as easily maintained as the modules using the high and middle levels of cohesion

Example:

Suppose there is a module which intends to repair the damaged record of the database and then update the maintenance file. In this kind of application we can't repair the damaged record without reading it from the database; we can only repair the record after reading it from the database. So the order the execution may be:

- i. Read part number from data base
- ii. Update repair record on maintenance file.

v. Communicational Cohesion

In communicational cohesion, module performs a series of actions related by a sequence of steps to be followed by the product and all actions are performed on the same data. A communication ally cohesive module is one which performs several functions on the same input or output data. Communicational cohesion is an acceptable level of cohesion although it is not as good as functional or sequential cohesion. Communicationally cohesive modules are easy to maintain. In

this type of cohesion other modules may require only part of the input or output data of the communicationally cohesive module, making the unnecessary data redundant. The designer must decide whether to discard the redundant data or create a second module passing only the necessary data. But creating a second module causes duplication of code, making maintenance more difficult. It is easier to share code within a communicationally cohesive module. This may make it more difficult to make changes in one part of the code without affecting the functionality of another part of the code.

Example:

There is a student record in the database and from the student record multiple data is derived as shown below:

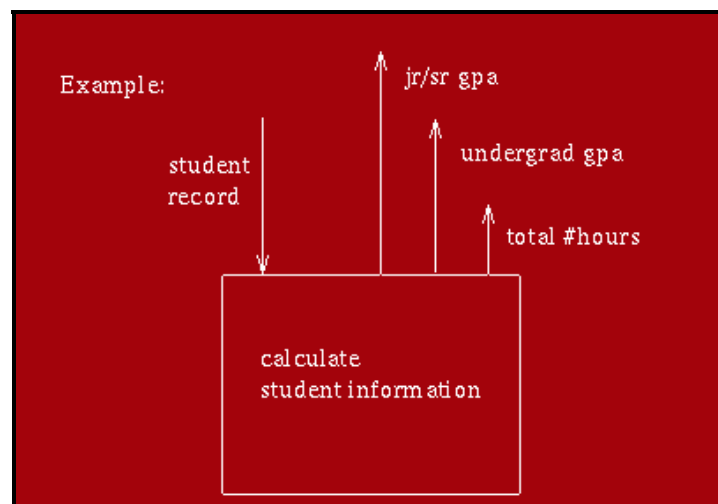

vi. Sequential Cohesion

A sequentially cohesive module contains activities where output data from one activity serves as input data to the next activity. In general, a sequentially cohesive module has good coupling and is easy to maintain. Sequentially cohesive modules are not as good candidates for re-use as are functionally cohesive modules. This is because the activities contained within the sequentially cohesive module generally only meet the requirements of that one module.

Example:

Suppose we want to edit the customer data we need to perform the following tasks in sequence:

- i. Retrieve customer Data
- ii. Retrieve customer order

- iii. Generate invoice
- iv. Get and edit input data.

vii. Functional Cohesion – Highly cohesive

A functionally cohesive module performs one and only one problem related task and every essential element to a single computation is contained in the component. A functionally cohesive module performs one and only one problem related task. This is ideal situation. Functionally cohesive modules may be simple and perform one task, such as Read Customer Record. However, a complex module with numerous sub modules may still be functionally cohesive if all of its subordinate modules are only performed to carry out the task of the parent module. Functionally cohesive modules are good candidates for re-use and systems built with functionally cohesive modules are easily understood and, therefore, easier to maintain.

Example:

- i. Drag Drop – an event triggered when a dragged object is dropped on a window,
- ii. Sum Elements in Array,
- iii. Read Customer Record,
- iv. Calculate Net Pay
- v. Assign Account Number

A complex module with numerous sub modules may still be functionally cohesive if all of its subordinate modules are only performed to carry out the task of the parent module. For example, Calculate Net Pay is functionally cohesive although it contains many different functions (e.g., calculate taxable deductions, calculate tax, and calculate CPP deduction).

Scale of Cohesion Vs Maintainability

Functional	BEST MAINTAINABILITY	Black box
Sequential		Not-quite-so-black box
Communicational		Gray box
Procedural		White or transparent box
Temporal		
Logical		
Coincidental		WORST MAINTAINABILITY

Problem Statement

In the electric subsystem of the house where there are electric wires and appliances running. Each appliance is having its own functionality and working. Each appliance is having its own clear boundary into which it works.

To do Tasks:

- i. **Task is to identify level of coupling and cohesion in the scenario.**

Solution:

The given scenario is having no interdependency and each appliance is encapsulated within its own boundary so the system is having low or no coupling but high level of cohesion.

Extensibility:

As change is the only constant in the software, extendibility is the ease of adapting software products to changes of specification. **Extensibility** (sometimes confused with forward compatibility) is a software design principle where the implementation takes into consideration future growth. It is a systemic measure of the ability to extend a system and the level of effort required to implement the extension. Extensions can be through the addition of new functionality or through modification of existing functionality. The central theme is to provide for change - atypically enhancements - while minimizing impact to existing system functions. Although forward compatibility and extensibility are similar, they are not the same. A forward compatible system can accept data from a future version of itself and pick out the "known" part of the data. An example is a text-only word processor ignoring picture data from a future version. An extensible system is one that can be upgraded to fully handle the new data in the newer input format. An example is the above mentioned word processor that can be upgraded to handle picture data or a browser that needs added functionality to successfully load and display certain document or file formats. In systems architecture, extensibility means the system is designed to include hooks and mechanisms for expanding/enhancing the system with new capabilities without having to make major changes to the system infrastructure. A good architecture provides the design principles to ensure this—a roadmap for that portion of the road yet to be built. Note that this usually means that capabilities and mechanisms must be built into the final delivery which will not be used in that delivery and, indeed, may never be used. These excess capabilities are *not add-ons*, but are necessary for maintainability and for avoiding early obsolescence.

Extensibility can also mean that a software system's behavior is modifiable at runtime, without recompiling or changing the original source code. For example, a software system may have a public Application Programming Interface that allows its behavior to be extended or modified by people who don't have access to the original source code. The extra functionality can be provided through either internally or externally coded extensions. A good software design is extensible **and** is “open-ended”. It should solve a class of problems rather than a single instance. We should try not to introduce what is immaterial and do not restrict what is irrelevant.

When is code extensible?

There are three points at which code may be extended:

- i. **Compile time:** change our source code to pick up new functionality; this may mean adding new objects in new source code files and changing a factory function.
- ii. **Link time:** arrange for changes to be picked up by the linker only; this may involve some magic for new objects to be found, this can be self defeating as it inevitably adds some obscurity to the code and possibly the makefiles too.
- iii. **Run time:** dynamically loaded libraries were invented for this sort of thing. This can also lead to obscurity in the code and usually makes debugging more complex because you may have to wait for a library to be loaded before you can set break points.

Although run time extension is truest to the idea of extendable code (because you don't change any of the existing code) I don't think this buys much over a good compile-time extension system. Run-time extension has its uses, such as in very dynamic systems, or non-stop applications but it also complicates version tracking and configuration management. Sometimes the simplest thing is to actually change some of the existing code. What is simplest and best depends on your circumstances. Actually adding a line and recompiling will be the simplest solution.

How does extensibility work?

Extensibility forces an approach to problems based on:

i. An upfront design which allows for addition

This is not to make a case for big up front design - quite the opposite in fact. Big up front design assumes you can design the entire system up front. An extensible design accepts you can't design everything in advance, instead it provides a light framework which can allow for changes.

ii. Additions to be made in small, incremental steps

It is possible to produce an extensible system where the increments are big. We can give command to execute a task, the commands could be small, "Put the kettle on", rather than big: "Take over the world." If we make our commands too big we lose the element of extensibility, the original problem is relocated inside a single command, which is effectively the entire system.

iii. Work elements to be separated into comprehensible units

Computers may run programs and source code may be compiled by a tool, but it is humans who

have to read and understand the system. There is a human factor to all of this, just because we can write an immensely complex piece of code doesn't mean we should. Anyone who has tried to maintain by hand code that was originally produced by a code generator will have seen this problem

How does extensibility help?

To achieve these objectives we need to emphasize traditional software development issues: high cohesion, low coupling, interface-implementation separation, minimize dependencies, and develop build procedures to perform constant integration. This imposes a discipline on our development. Extensible design fits well with the principles advocated by the agile methodologies and iterative development. It allows functionality to be implemented in small steps as required, thus it dovetails with the minimal implementation, iterative development and frequent re-prioritization often advocated by Agile development. In an extensible design we cannot afford for one chunk to be too closely coupled with other chunks. The very essence of the system is embracing change, it is accepted that additions will be continual, if one chunk of the system resists such change it will make the whole design unworkable. Thus, we have placed the friction of change centre stage. Normally we would rather not think about friction, it is a problem we want to go away. By elevating the issue we are directly addressing it, the whole system is designed around the idea of change through addition. If you are the kind of person who likes new, green-field, system development this may sound pretty horrid. Basically, I'm suggesting lay minimal foundations of specification, design and framework coding and making a quick dash for the maintenance phase where you actually fit the functionality.

Extensibility is not “reuse”

Extensibility a no magic bullet, it is just another technique in our toolbox for tackling software development. Nor is it a code word for “reuse”. True, many of the properties emphasized by extensibility is the same ones preached for reusable code: low coupling, high cohesion, modularity, but these properties are advocated by most software engineering themes. Indeed, who would argue for tightly coupled systems? It may be that, having an extensible system, with malleable code allows your technology to be transferred to another project – many of the properties required of an extensible system make transfer easier. One could easily imagine a word processor system which offered a standard system and a *beginner* version with fewer options, plus a *professional* version with more – But, such platform transfer is deriving from the minimalist camp - “less is more” is the starting point. Extensible software development is no license to add bells and whistles to your code in the hope that someone may use them. Quite the opposite,

extendable software should be free of bells and whistles; it should be minimal while allowing itself to be extended. Striving for extensibility should impose a discipline on development leading to fewer, cleaner, dependencies, well defined interfaces and abstractions with corresponding reduction in coupling and higher cohesion.

LECTURE NO: 12 and 13

Objectives:

In this chapter we will briefly review the object oriented programming concepts from programming view point and we will implement these concepts in Java programming language using Eclipse IDE.

Object Oriented Programming Concepts:

To execute the sample programs below you need to download the following software's from the mentioned websites:

i. Java Runtime Environment (JRE)

URL:

<http://www.oracle.com/technetwork/java/javase/downloads/jre-6u25-download-346243.html>

ii. Eclipse IDE

URL: <http://www.eclipse.org/>

After downloading the mentioned software, install JRE and unzip Eclipse and place it on any drive like C or D. To execute eclipse click on the Eclipse icon available in the folder.

i. Objects:

Objects are key to understanding *object-oriented* technology. Look around right now and you'll find many examples of real-world objects: your dog, your desk, your television set, your bicycle. Real-world objects share two characteristics: They all have *state* and *behavior*. Human have state (name, color, race) and behavior (walk, eat, talk). Bicycles also have state (current gear, current pedal cadence, and current speed) and behavior (changing gear, changing pedal cadence, applying brakes). Identifying the state and behavior for real-world objects is a great way to begin thinking in terms of object-oriented programming. If we observe the real-world objects that are in our immediate area. For each object that you see, ask yourself two questions: "What possible states can this object be in?" and "What possible behavior can this object perform?". Make sure to write down your observations. As you do, you'll notice that real-world objects vary in complexity; your desktop lamp may have only two possible states (on and off) and two possible behaviors (turn on, turn off), but your desktop radio might have additional states (on, off, current volume, current

station) and behavior (turn on, turn off, increase volume, decrease volume, seek, scan, and tune).

You may also notice that some objects, in turn, will also contain other objects. These real-world observations all translate into the world of object-oriented programming.

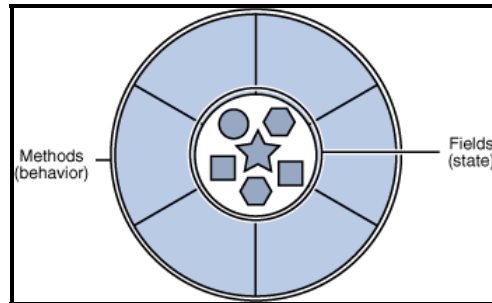

Software objects are conceptually similar to real-world objects: they too consist of state and related behavior. An object stores its state in *fields* (variables in some programming languages) and exposes its behavior through *methods* (functions in some programming languages). Methods operate on an object's internal state and serve as the primary mechanism for object-to-object communication. Hiding internal state and requiring all interaction to be performed through an object's methods is known as *data encapsulation* — a fundamental principle of object-oriented programming.

i. Class

In the real world, you'll often find many individual objects all of the same kind. A *class* is the blueprint from which individual objects are created. A class contains variables to represent the properties of the class and methods which are used for processing the different business logic for that particular class.

For example, there may be thousands of other bicycles in existence, all of the same make and model. Each bicycle was built from the same set of blueprints and therefore contains the same components. In object-oriented terms, we say that your bicycle is an *instance* of the *class* of *objects* known as bicycles. The following Bicycle class is one possible implementation of a bicycle:

Sample Code in Java

```
class Bicycle {
    int cadence = 0;
    int speed = 0;
    int gear = 1;
    void changeCadence(int newValue) {
        cadence = newValue;
    }
}
```

```
}  
void changeGear(int newValue)  
{  
    gear = newValue;  
}  
  
void speedUp(int increment) {  
    speed = speed + increment;  
}  
void applyBrakes(int decrement) {  
    speed = speed - decrement;  
}  
  
void printStates() {  
    System.out.println("cadence:"+cadence+" speed:"+speed+" gear:"+gear);  
}  
}
```

The field's cadence, speed, and gear represent the object's state, and the methods (changeCadence, changeGear, speedUp etc.) define its interaction with the outside world.

You may have noticed that the Bicycle class does not contain a main method. That's because it's not a complete application; it's just the blueprint for bicycles that might be used in an application. The responsibility of creating and using new Bicycle objects belongs to some other class in your application.

Here's a BicycleDemo class that creates two separate Bicycle objects and invokes their methods:

```
class BicycleDemo {  
    public static void main(String[] args) {  
  
        // Create two different Bicycle objects  
        Bicycle bike1 = new Bicycle();  
        Bicycle bike2 = new Bicycle();  
  
        // Invoke methods on those objects  
        bike1.changeCadence(50);  
    }  
}
```

```
bike1.speedUp(10);  
bike1.changeGear(2);  
bike1.printStates();  
  
bike2.changeCadence(50);  
bike2.speedUp(10);  
bike2.changeGear(2);  
bike2.changeCadence(40);  
bike2.speedUp(10);  
bike2.changeGear(3);  
bike2.printStates();  
}  
}
```

The output of this test prints the ending pedal cadence, speed, and gear for the two bicycles:

```
cadence:50 speed:10 gear:2  
cadence:40 speed:20 gear:3
```

ii. Inheritance

It implies the functionality of data sharing between super and sub class. All the data members and methods of super class are available for use in sub class but not vice-versa. Subclass extends the functionality of super class to use the base class methods. Different kinds of objects often have a certain amount in common with each other. Mountain bikes, road bikes, and tandem bikes, for example, all share the characteristics of bicycles (current speed, current pedal cadence, current gear). Yet each also defines additional features that make them different: tandem bicycles have two seats and two sets of handlebars; road bikes have drop handlebars; some mountain bikes have an additional chain ring, giving them a lower gear ratio. Object-oriented programming allows classes to *inherit* commonly used state and behavior from other classes. In this example, Bicycle now becomes the *superclass* of MountainBike, RoadBike, and TandemBike. In the Java programming language, each class is allowed to have one direct superclass, and each superclass has the potential for an unlimited number of *subclasses*.

The syntax for creating a subclass is simple. At the beginning of your class declaration, use the **extends** keyword, followed by the name of the class to inherit from:

```
public class MountainBike extends Bicycle {
```

```
// the MountainBike subclass has one field
public int seatHeight;

// the MountainBike subclass has one constructor
public MountainBike(int startHeight, int startCadence, int startSpeed, int startGear) {
    super(startCadence, startSpeed, startGear);
    seatHeight = startHeight;
}

// the MountainBike subclass has one method
public void setHeight(int newValue) {
    seatHeight = newValue;
}
}

MountainBike inherits all the fields and methods of Bicycle and adds the field seatHeight and
a method to set it
```

iii. Abstract Classes

An *abstract class* is a class that is declared `abstract`—it may or may not include abstract methods. Abstract classes cannot be instantiated, but they can be subclassed.

An *abstract method* is a method that is declared without an implementation (without braces, and followed by a semicolon), like this:

```
abstract void moveTo(double deltaX, double deltaY);
```

If a class includes abstract methods, the class itself *must* be declared `abstract`, as in:

```
public abstract class GraphicObject {
    // declare fields
    // declare non-abstract methods
    abstract void draw();
}
```

When an abstract class is subclassed, the subclass usually provides implementations for all of the abstract methods in its parent class. However, if it does not, the subclass must also be declared abstract.

Example:

In an object-oriented drawing application, you can draw circles, rectangles, lines, Bezier curves, and many other graphic objects. These objects all have certain states (for example: position, orientation, line color, fill color) and behaviors (for example: moveTo, rotate, resize, draw) in common. Some of these states and behaviors are the same for all graphic objects—for example: position, fill color, and moveTo. Others require different implementations—for example, resize or draw. All GraphicObjects must know how to draw or resize themselves; they just differ in how they do it. This is a perfect situation for an abstract superclass. You can take advantage of the similarities and declare all the graphic objects to inherit from the same abstract parent object—for example, GraphicObject, as shown in the following figure.

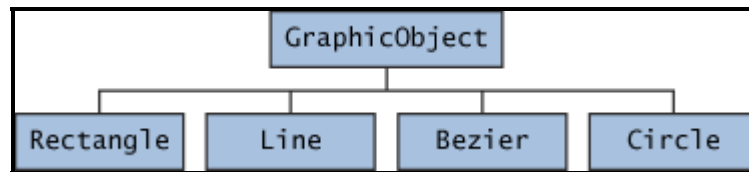

First, you declare an abstract class, GraphicObject, to provide member variables and methods that are wholly shared by all subclasses, such as the current position and the moveTo method. GraphicObject also declares abstract methods for methods, such as draw or resize, that need to be implemented by all subclasses but must be implemented in different ways. The GraphicObject class can look something like this:

```
abstract class GraphicObject {
    int x, y;
    ...
    void moveTo(int newX, int newY) {
        ...
    }
    abstract void draw();
    abstract void resize();
}
```

```
}
```

Each non-abstract subclass of `GraphicObject`, such as `Circle` and `Rectangle`, must provide implementations for the `draw` and `resize` methods:

```
class Circle extends GraphicObject {
    void draw() {
        ...
    }
    void resize() {
        ...
    }
}

class Rectangle extends GraphicObject {
    void draw() {
        ...
    }
    void resize() {
        ...
    }
}}
```

iv. Overriding and Hiding Methods

Instance Methods

An instance method in a subclass with the same signature (name, plus the number and the type of its parameters) and return type as an instance method in the superclass *overrides* the superclass's method. The ability of a subclass to override a method allows a class to inherit from a superclass whose behavior is "close enough" and then to modify behavior as needed. The overriding method has the same name, number and type of parameters, and return type as the method it overrides. An overriding method can also return a subtype of the type returned by the overridden method. This is called a *covariant return type*. When overriding a method, you might want to use the `@Override` annotation that instructs the compiler that you intend to override a method in the superclass. If, for some reason, the compiler detects that the method does not exist in one of the superclasses, it will generate an error.

Class Methods

If a subclass defines a class method with the same signature as a class method in the superclass, the method in the subclass *hides* the one in the superclass. The distinction between hiding and

overriding has important implications. The version of the overridden method that gets invoked is the one in the subclass. The version of the hidden method that gets invoked depends on whether it is invoked from the superclass or the subclass. Let's look at an example that contains two classes. The first is `Animal`, which contains one instance method and one class method:

```
public class Animal {
    public static void testClassMethod() {
        System.out.println("The class method in Animal.");
    }
    public void testInstanceMethod() {
        System.out.println("The instance method in Animal.");
    }
}
```

The second class, a subclass of `Animal`, is called `Cat`:

```
public class Cat extends Animal {
    public static void testClassMethod() {
        System.out.println("The class method in Cat.");
    }
    public void testInstanceMethod() {
        System.out.println("The instance method in Cat.");
    }

    public static void main(String[] args) {
        Cat myCat = new Cat();
        Animal myAnimal = myCat;
        Animal.testClassMethod();
        myAnimal.testInstanceMethod();
    }
}
```

The `Cat` class overrides the instance method in `Animal` and hides the class method in `Animal`. The main method in this class creates an instance of `Cat` and calls `testClassMethod()` on the class and `testInstanceMethod()` on the instance.

The output from this program is as follows:

The class method in Animal.

The instance method in Cat.

As discussed, the version of the hidden method that gets invoked is the one in the superclass, and the version of the overridden method that gets invoked is the one in the subclass.

Modifiers

The access specifier for an overriding method can allow more, but not less, access than the overridden method. For example, a protected instance method in the superclass can be made public, but not private, in the subclass. You will get a compile-time error if you attempt to change an instance method in the superclass to a class method in the subclass, and vice versa.

v. Polymorphism

The dictionary definition of *polymorphism* refers to a principle in biology in which an organism or species can have many different forms or stages. This principle can also be applied to object-oriented programming and languages like the Java language. Subclasses of a class can define their own unique behaviors and yet share some of the same functionality of the parent class. Polymorphism can be demonstrated with a minor modification to the Bicycle class. For example, printDescription method could be added to the class that displays all the data currently stored in an instance.

```
public void printDescription(){  
  
    System.out.println("\nBike is in gear " + this.gear + " with a cadence of " + this.cadence + " and  
    travelling at a speed of " + this.speed + ".");  
  
}
```

To demonstrate polymorphic features in the Java language, extend the Bicycle class with a MountainBike and a RoadBike class. For MountainBike, add a field for suspension, which is a String value that indicates if the bike has a front shock absorber, Front. Or, the bike has a front and back shock absorber, Dual.

Here is the updated class:

```
public class MountainBike extends Bicycle{  
    private String suspension;
```

```
public MountainBike(int startCadence, int startSpeed, int startGear, String suspensionType){
    super(startCadence, startSpeed, startGear);
    this.setSuspension(suspensionType);
}

public String getSuspension(){
    return this.suspension;
}

public void setSuspension(String suspensionType){
    this.suspension = suspensionType;
}

public void printDescription(){
    super.printDescription();
    System.out.println("The MountainBike has a " + getSuspension() + " suspension.");
}}
```

Note the overridden printDescription method. In addition to the information provided before, additional data about the suspension is included to the output. Next, create the RoadBike class. Because road or racing bikes have skinny tires, add an attribute to track the tire width. Here is the RoadBike class:

```
public class RoadBike extends Bicycle{
    private int tireWidth; // In millimeters (mm)

    public RoadBike(int startCadence, int startSpeed, int startGear, int newTireWidth){
        super(startCadence, startSpeed, startGear);
        this.setTireWidth(newTireWidth);
    }

    public int getTireWidth(){
        return this.tireWidth;
    }

    public void setTireWidth(int newTireWidth){
        this.tireWidth = newTireWidth;
    }
}
```

```
}  
  
public void printDescription(){  
    super.printDescription();  
    System.out.println("The RoadBike has " + getTireWidth() + " MM tires.");  
}}
```

Note that once again, the printDescription method has been overridden. This time, information about the tire width is displayed. To summarize, there are three classes: Bicycle, MountainBike, and RoadBike. The two subclasses override the printDescription method and print unique information.

Here is a test program that creates three Bicycle variables. Each variable is assigned to one of the three bicycle classes. Each variable is then printed.

```
public class TestBikes {  
    public static void main(String[] args){  
        Bicycle bike01, bike02, bike03;  
  
        bike01 = new Bicycle(20, 10, 1);  
        bike02 = new MountainBike(20, 10, 5, "Dual");  
        bike03 = new RoadBike(40, 20, 8, 23);  
  
        bike01.printDescription();  
        bike02.printDescription();  
        bike03.printDescription();  
  
    }  
}
```

The following is the output from the test program:

Bike is in gear 1 with a cadence of 20 and travelling at a speed of 10.

Bike is in gear 5 with a cadence of 20 and travelling at a speed of 10.

The MountainBike has a Dual suspension.

Bike is in gear 8 with a cadence of 40 and travelling at a speed of 20.

The RoadBike has 23 MM tires.

The Java virtual machine (JVM) calls the appropriate method for the object that is referred to in each variable. It does not call the method that is defined by the variable's type. This behavior is referred to as *virtual method invocation* and demonstrates an aspect of the important polymorphism features in the Java language.

vi. Interface

As we've already learned, objects define their interaction with the outside world through the methods that they expose. Methods form the object's *interface* with the outside world; the buttons on the front of your television set, for example, are the interface between you and the electrical wiring on the other side of its plastic casing. You press the "power" button to turn the television on and off. In its most common form, an interface is a group of related methods with empty bodies.

An interface declaration consists of modifiers, the keyword `interface`, the interface name, a comma-separated list of parent interfaces (if any), and the interface body. For example:

```
public interface GroupedInterface extends Interface1,Interface2, Interface3 {  
  
    // constant declarations  
    double E = 2.718282; // base of natural logarithms  
  
    // method signatures  
    void doSomething (int i, double x);  
    int doSomethingElse(String s);  
  
}
```

The public access specifier indicates that the interface can be used by any class in any package. If you do not specify that the interface is public, your interface will be accessible only to classes defined in the same package as the interface.

An interface can extend other interfaces, just as a class can extend or subclass another class. However, whereas a class can extend only one other class, an interface can extend any number of interfaces. The interface declaration includes a comma-separated list of all the interfaces that it extends.

The Interface Body

The interface body contains method declarations for all the methods included in the interface. A method declaration within an interface is followed by a semicolon, but no braces, because an

interface does not provide implementations for the methods declared within it. All methods declared in an interface are implicitly public, so the public modifier can be omitted. An interface can contain constant declarations in addition to method declarations. All constant values defined in an interface are implicitly public, static, and final. Once again, these modifiers can be omitted. To declare a class that implements an interface, you include an implements clause in the class declaration. Your class can implement more than one interface, so the implements keyword is followed by a comma-separated list of the interfaces implemented by the class. By convention, the implements clause follows the extends clause, if there is one.

A Sample Interface, Relatable

Consider an interface that defines how to compare the size of objects.

```
public interface Relatable {  
  
    // this (object calling isLargerThan) and  
    // other must be instances of the same class  
    // returns 1, 0, -1 if this is greater  
    // than, equal to, or less than other  
    public int isLargerThan(Relatable other);  
}
```

If you want to be able to compare the size of similar objects, no matter what they are, the class that instantiates them should implement Relatable. Any class can implement Relatable if there is some way to compare the relative "size" of objects instantiated from the class. For strings, it could be number of characters; for books, it could be number of pages; for students, it could be weight; and so forth. For planar geometric objects, area would be a good choice (see the RectanglePlus class that follows), while volume would work for three-dimensional geometric objects. All such classes can implement their isLargerThan() method. If you know that a class implements Relatable, then you know that you can compare the size of the objects instantiated from that class.

Implementing the Relatable Interface

Here is the Rectangle class written to implement Relatable.

```
public class RectanglePlus implements Relatable {  
    public int width = 0;  
    public int height = 0;
```

```
public Point origin;

// four constructors
public RectanglePlus() {
    origin = new Point(0, 0);
}
public RectanglePlus(Point p) {
    origin = p;
}
public RectanglePlus(int w, int h) {
    origin = new Point(0, 0);
    width = w;
    height = h;
}
public RectanglePlus(Point p, int w, int h) {
    origin = p;
    width = w;
    height = h;
}

// a method for moving the rectangle
public void move(int x, int y) {
    origin.x = x;
    origin.y = y;
}

// a method for computing the area of the rectangle
public int getArea() {
    return width * height;
}

// a method required to implement the Relatable interface
public int isLargerThan(Relatable other) {
    RectanglePlus otherRect = (RectanglePlus)other;
    if (this.getArea() < otherRect.getArea())
        return -1;
    else if (this.getArea() > otherRect.getArea())
```

```
        return 1;
    else
        return 0;
}
}
```

Because RectanglePlus implements Relatable, the size of any two RectanglePlus objects can be compared.

Likewise another example of A bicycle's behavior, if specified as an interface, might appear as follows:

```
interface Bicycle {

    void changeCadence(int newValue); // wheel revolutions per minute

    void changeGear(int newValue);

    void speedUp(int increment);

    void applyBrakes(int decrement);
}
```

To implement this interface, the name of your class would change (to a particular brand of bicycle, for example, such as ACMEBicycle), and you'd use the implements keyword in the class declaration:

```
class ACMEBicycle implements Bicycle {

    // remainder of this class implemented as before

}
```

Implementing an interface allows a class to become more formal about the behavior it promises to provide. Interfaces form a contract between the class and the outside world, and this contract is enforced at build time by the compiler. If your class claims to implement an interface, all methods defined by that interface must appear in its source code before the class will successfully compile.

vii. Interface vs Abstract Classes

Unlike interfaces, abstract classes can contain fields that are not static and final, and they can contain implemented methods. Such abstract classes are similar to interfaces, except that they provide a partial implementation, leaving it to subclasses to complete the implementation. If an abstract class contains *only* abstract method declarations, it should be declared as an interface instead. Multiple interfaces can be implemented by classes anywhere in the class hierarchy, whether or not they are related to one another in any way. By comparison, abstract classes are most commonly subclassed to share pieces of implementation. A single abstract class is subclassed by similar classes that have a lot in common (the implemented parts of the abstract class), but also have some differences (the abstract methods).

viii. Writing Final Classes and Methods

You can declare some or all of a class's methods *final*. You use the final keyword in a method declaration to indicate that the method cannot be overridden by subclasses. The Object class does this—a number of its methods are final. You might wish to make a method final if it has an implementation that should not be changed and it is critical to the consistent state of the object. For example, you might want to make the `getFirstPlayer` method in `thisChessAlgorithm` class final:

```
class ChessAlgorithm {
    enum ChessPlayer { WHITE, BLACK }
    ...
    final ChessPlayer getFirstPlayer() {
        return ChessPlayer.WHITE;
    }
    ...
}
```

Methods called from constructors should generally be declared final. If a constructor calls a non-final method, a subclass may redefine that method with surprising or undesirable results. Note that you can also declare an entire class final — this prevents the class from being subclassed. This is particularly useful, for example, when creating an immutable class like the String class.

ix. Using this keyword

Within an instance method or a constructor, `this` is a reference to the *current object* — the object whose method or constructor is being called. You can refer to any member of the current object from within an instance method or a constructor by using `this`.

Using this with a Field

The most common reason for using the `this` keyword is because a field is shadowed by a method or constructor parameter.

For example, there is a `Point` class written like this

```
public class Point {
    public int x = 0;
    public int y = 0;

    //constructor
    public Point(int a, int b) {
        x = a;
        y = b;
    }
}
```

but it could have been written like this:

```
public class Point {
    public int x = 0;
    public int y = 0;

    //constructor
    public Point(int x, int y) {
        this.x = x;
        this.y = y;
    }
}
```

Each argument to the constructor shadows one of the object's fields — inside the constructor `x` is a local copy of the constructor's first argument. To refer to the `Point` field `x`, the constructor must use `this.x`.

Using this with a Constructor

From within a constructor, you can also use the `this` keyword to call another constructor in the same class. Doing so is called an *explicit constructor invocation*.

```
public class Rectangle {
    private int x, y;
```

```
private int width, height;

public Rectangle() {
    this(0, 0, 0, 0);
}
public Rectangle(int width, int height) {
    this(0, 0, width, height);
}
public Rectangle(int x, int y, int width, int height) {
    this.x = x;
    this.y = y;
    this.width = width;
    this.height = height;
}
...
}
```

This class contains a set of constructors. Each constructor initializes some or all of the rectangle's member variables. The constructors provide a default value for any member variable whose initial value is not provided by an argument. For example, the no-argument constructor calls the four-argument constructor with four 0 values and the two-argument constructor calls the four-argument constructor with two 0 values. As before, the compiler determines which constructor to call, based on the number and the type of arguments. If present, the invocation of another constructor must be the first line in the constructor.

x. Static methods

A Static method in Java is one that belongs to a class rather than an object of a class. Normal methods of a class can be invoked only by using an object of the class but a Static method can be invoked directly without object. In java we have two types of methods, **instance methods** and **static methods**. Instance methods can be called by the object of a Class whereas static method are called by the Class. When objects of a Class are created, they have their own copy of instance methods and variables, stored in different memory locations. Static Methods and variables are shared among all the objects of the Class, stored in one fixed location in memory. Static methods *cannot* access instance variables or instance methods directly-they must use an object reference. Also, class methods cannot use the `this` keyword as there is no instance for `this` to refer to. Static methods can't use any instance variables. The `this` keyword can't be used in a static methods. You can find it difficult to understand when to use a static method and when

not to use. If you have a better understanding of the instance methods and static methods then you can know where to use instance method and static method. A static method can be accessed without creating an instance of the class. If you try to use a non-static method and variable defined in this class then the compiler will say that non-static variable or method cannot be referenced from a static context. Static method can call only other static methods and static variables defined in the class. The concept of static method will get more clear after this program. First of all create a class **HowToAccessStaticMethod**. Now define two variables in it, one is instance variable and other is class variable. Make one static method named **staticMethod()** and second named as **nonStaticMethod()**. Now try to call both the method without constructing a object of the class. You will find that only static method can be called this way.

```
public class HowToAccessStaticMethod{
    int i;
    static int j;
    public static void staticMethod() {
        System.out.println("you can access a static method this way");
    }
    public void nonStaticMethod() {
        i=100;
        j=1000;
        System.out.println("Don't try to access a non static method");
    }
    public static void main(String[] args) {
        //i=100;

        j=1000;
        //nonStaticMethod();
        staticMethod();
    }
}
```

LECTURE 14:

Motivation for Open Close Principle (OCP)

A clever application design and the code writing part should take care of the frequent changes that are done during the development and the maintaining phase of an application. Usually, many changes are involved when a new functionality is added to an application. Those changes in the existing code should be minimized, since it's assumed that the existing code is already unit tested and changes in already written code might affect the existing functionality in an unwanted manner. The **Open Close Principle** states that the design and writing of the code should be done in a way that new functionality should be added with minimum changes in the existing code. The design should be done in a way to allow the adding of new functionality as new classes, keeping as much as possible existing code unchanged.

Open Close Principle (OCP):

There are many heuristics associated with object oriented design. For example, “all member variables should be private”, or “global variables should be avoided”, or “using run time type identification (RTTI) is dangerous”. What is the source of these heuristics? What makes them true? Are they *always* true? This column investigates the design principle that underlies these heuristics -- the open-closed principle. As Ivar Jacobson said:

“All systems change during their life cycles. This must be borne in mind when developing systems expected to last longer than the first version.”

How can we create designs that are stable in the face of change and that will last longer than the first version?

Bertrand Meyer gave us guidance as long ago as 1988 when he coined the now famous open-closed principle. To paraphrase him:

“Software entities like classes, modules and functions should be open for extension but closed for modifications”

Meyer’s used inheritance to solve the apparent dilemma of the principle. His idea was that once completed, the implementation of a class could only be modified to correct errors, but new or changed features would require that a different class be created. When a single change to a program results in a cascade of changes to dependent modules, that program exhibits the undesirable attributes that we have come to associate with “bad” design. The program becomes fragile, rigid, unpredictable and un-reusable. The open closed principle attacks this in a very straightforward way. It says that you should design modules that *never change*. When requirements change, you extend the behavior of such modules by adding new code, not by changing old code that already works.

Modules that conform to the open-closed principle have two primary attributes:

I. They are “Open For Extension”

This means that the behavior of the module can be extended. That we can make the module behave in new and different ways as the requirements of the application change, or to meet the needs of new applications.

II. They are “Closed for Modification”

The source code of such a module is inviolate. No one is allowed to make source code changes to it.

It would seem that these two attributes are at odds with each other. The normal way to extend the behavior of a module is to make changes to that module. A module that cannot be changed is normally thought to have a fixed behavior. How can these two opposing attributes be resolved?

The answer is *abstraction*. In Java or any other object-oriented programming language (OOPL), it is possible to create abstractions that are fixed and yet represent an unbounded group of possible behaviors. The abstractions are abstract base classes, and the unbounded group of possible behaviors is represented by all the possible derivative classes.

It is not possible to have all the modules of a software system satisfy the OCP, but we should attempt to minimize the number of modules that do not satisfy it. The Open-Closed Principle is really the heart of OO design, conformance to this principle yields the greatest level of reusability and maintainability.

Applying Open Close Principle (OCP):

OCP is about arranging encapsulation in such a way that it's effective, yet open enough to be extensible. This is a compromise, i.e. **“expose only the moving parts that need to change, hide everything else”**. The Open/Closed principle can be applied in object oriented paradigms with the help of **inheritance** and **polymorphism**:

- i. The interface of the module becomes an abstract class A
- ii. If needed new Subclasses of A can be derived; these subclasses may extend A

These two steps are shown graphically below:

Before Applying OCP

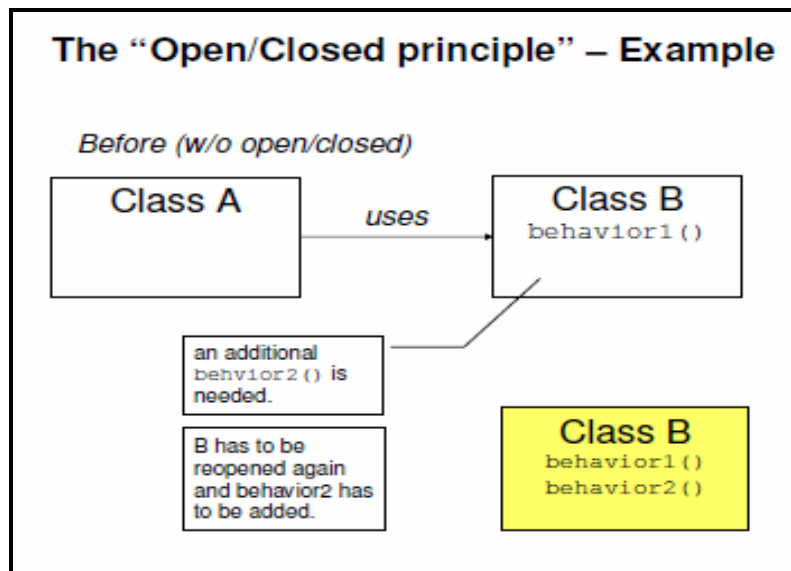

After Applying OCP

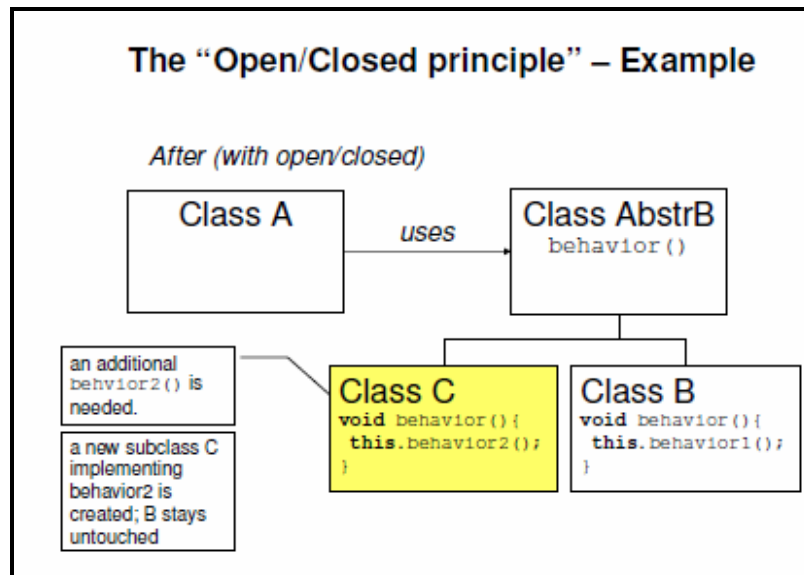

Example - 1:

We have to implement the banking system such that there will be an interface for the customer and the bank will be handling different type of accounts in it like savings, current, Giro etc; each type of account is having its own business logic to implement and policy. Bank foresees the emergence of new type of accounts, we have to design the system which should take into consideration the current requirements and should be able to adapt to future changes.

To Do Task:

- We have to design the system using Open / Close Principle

Proposed Solution

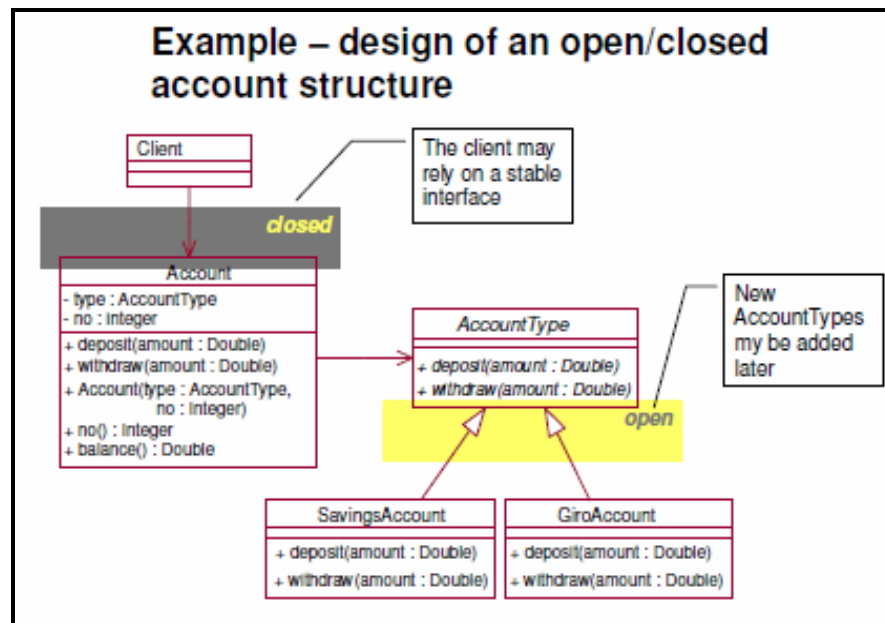

Example - 2:

- **Given the Java code below, we need to identify whether it confirm to OCP or not.**

Java Code:

```
public interface Shape
{
    void Draw();
}
public class Square extends Shape
{
    public void Draw()
    {
        // draw a square
    }
}

public class Circle extends Shape
{
    public void Draw()
    {
        // draw a circle
    }
}

public void DrawAllShapes(IList shapes)
{
    foreach(Shape shape in shapes)
        shape.Draw();
}
```

Solution:

Note that if we want to extend the behavior of the DrawAllShapes function above to draw a new kind of shape, all we need do is add a new derivative of the Shape class. The DrawAllShapes function does not need to change. Thus, DrawAllShapes conforms to OCP. Its behavior can be extended without modifying it. Indeed, adding a triangle class has absolutely no effect on any of the modules shown here. Clearly, some part of the system must change in order to deal with the triangle class, but all the code shown here is immune to the change.

In a real application, the Shape class would have many more methods. Yet adding a new shape to the application is still quite simple, since all that is required is to create the new derivative and implement all its functions. There is no need to hunt through all the application, looking for places that require changes. *This solution is not fragile.*

Nor is the solution rigid. No existing source modules need to be modified, and no existing binary modules need to be rebuilt – with one exception. The module that creates instances of the new derivative of Shape must be modified. Typically, this is done by main, in some function called by main, or in the method of some object created by main.

Finally, *the solution is not immobile.* DrawAllShapes can be reused by any application without the need to bring Square or Circle along for the ride. Thus, the solution exhibits none of the attributes of bad design mentioned.

This program conforms to OCP. *It is changed by adding new code rather than by changing existing code.* Therefore, the program does not experience the cascade of changes exhibited by nonconforming programs.

But consider what would happen to the DrawAllShapes function if we decided that all Circles should be drawn before any Squares. The DrawAllShapes function is not closed against a change, like this. To implement that change, we'll have to go into DrawAllShapes and scan the list first for Circles and then again for Squares.

Anticipation and “Natural” Structure

Had we anticipated this kind of change, we could have invented an abstraction that protected us from it. The abstractions we chose above are more of a hindrance to this kind of change than a help. You may find this surprising; after all, what could be more natural than a Shape base class with Square and Circle derivatives? Why isn't that natural, real-world model the best one to use? Clearly, the answer is that model is not natural in a system in which ordering is coupled to shape type.

This leads us to a disturbing conclusion. In general, no matter how “closed” a module is, there will always be some kind of change against which it is not closed. *There is no model that is natural to all contexts! Since closure cannot be complete, it must be strategic.* That is, the designer must choose the kinds of changes against which to close the design, must guess at the kinds of changes that are most likely, and then construct abstractions to protect against those changes. This takes a certain amount of prescience derived from experience. Experienced designers hope that they know the users and the industry well enough to judge the probability of various kinds of changes. These designers then invoke OCP against the most probable changes.

LECTURE NO: 15

Objective:

In this lecture we will have discussion on basics of Unified Modeling Language (UML) from historical view point and on a broader spectrum we will discuss Use Case Diagram of UML which will form the basis for other diagrams of UML.

An historical Perspective of Unified Modeling Language (UML):

Identifiable object-oriented modeling languages began to appear between mid-1970 and the late 1980s as various methodologists experimented with different approaches to object-oriented analysis and design. The number of identified modeling languages increased from less than 10 to more than 50 during the period between **1989-1994**. Many users of OO methods had trouble finding complete satisfaction in any one modeling language, fueling the "**method wars.**" By the mid-1990s, new iterations of these methods began to appear and these methods began to incorporate each other's techniques, and a few clearly prominent methods emerged. The development of UML began in late 1994 when Grady Booch and Jim Rumbaugh of Rational Software Corporation began their work on unifying the Booch and OMT (Object Modeling Technique) methods. In the Fall of 1995, Ivar Jacobson and his Objectory company joined Rational and this unification effort, merging in the OOSE (Object-Oriented Software Engineering) method.

Reason for creating Unified Modeling Language:

There were three main reasons for creating Unified Modeling Language (UML):

- i. These methods (Booch, OMT, and OOSE methods) were already evolving toward each other independently. It made sense to continue that evolution together rather than apart, eliminating the potential for any unnecessary and gratuitous differences that would further confuse users.
- ii. By unifying the semantics and notation, they could bring some stability to the object-oriented marketplace, allowing projects to settle on one mature modeling language and letting tool builder's focus on delivering more useful features.

- iii. They expected that their collaboration would yield improvements in all three earlier methods, helping them to capture lessons learned and to address problems that none of their methods previously handled well.

The efforts of Booch, Rumbaugh, and Jacobson resulted in the release of the UML 0.9 and 0.91 documents in June and October of 1996. During 1996, the UML authors invited and received feedback from the general community. While Rational was bringing UML together, efforts were being made on achieving the broader goal of an industry standard modeling language. In early 1995, Ivar Jacobson (then Chief Technology Officer of Objectory) and Richard Soley (then Chief Technology Officer of OMG) decided to push harder to achieve standardization in the methods marketplace. In June 1995, an OMG-hosted meeting of all major methodologists (or their representatives) resulted in the first worldwide agreement to seek methodology standards, under the aegis of the OMG process. During 1996, it became clear that several organizations saw UML as strategic to their business. A Request for Proposal (RFP) issued by the Object Management Group (OMG) provided the catalyst for these organizations to join forces around producing a joint RFP response. Rational established the UML Partners consortium with several organizations willing to dedicate resources to work toward a strong UML 1.0 definition. Those contributing most to the UML 1.0 definition included: Digital Equipment Corp., HP, i-Logix, IntelliCorp, IBM, ICON Computing, MCI Systemhouse, Microsoft, Oracle, Rational Software, TI, and Unisys. This collaboration produced UML 1.0, a modeling language that was well defined, expressive, powerful, and generally applicable. This was submitted to the OMG in January 1997 as an initial RFP response. January 1997 IBM, ObjecTime, Platinum Technology, Ptech, Taskon, Reich Technologies and Softeam also submitted separate RFP responses to the OMG. These companies joined the UML partners to contribute their ideas, and together the partners produced the revised UML 1.1 response. The focus of the UML 1.1 release was to improve the clarity of the UML 1.0 semantics and to incorporate contributions from the new partners. It was submitted to the OMG for their consideration and adopted in the fall of 1997. UML has matured significantly since UML 1.1. Several minor revisions (UML 1.3, 1.4, and 1.5) fixed shortcomings and bugs with the first version of UML, followed by the UML 2.0 major revision that was adopted by the OMG in 2005. Although UML 2.1 was never released as a formal specification, versions 2.1.1 and 2.1.2 appeared in 2007, followed by UML 2.2 in February 2009. UML 2.3 was formally released in May 2010. UML 2.4 is in the beta stage as of today i-e May -2011

What is UML

The Unified Modeling Language (UML) is a standard language for specifying, visualizing, constructing, and documenting the artifacts of software systems, as well as for business modeling

and other non-software systems. The UML represents a collection of best engineering practices that have proven successful in the modeling of large and complex systems.¹ The UML is a very important part of developing objects oriented software and the software development process. The UML uses mostly graphical notations to express the design of software projects. Using the UML helps project teams communicate, explore potential designs, and validate the architectural design of the software.

Goals of UML

1. Provide users with a ready-to-use, expressive visual modeling language so they can develop and exchange meaningful models.
2. Provide extensibility and specialization mechanisms to extend the core concepts.
3. Be independent of particular programming languages and development processes.
4. Provide a formal basis for understanding the modeling language.
5. Encourage the growth of the OO tools market.
6. Support higher-level development concepts such as collaborations, frameworks, patterns and components.
7. Integrate best practices.

UML is not a development methodology rather it's a collection of standard set of diagrams which represents the state the system under consideration in graphical form from different view point. This is collection of performing Object Oriented Analysis and Design of the system with the support of a graphical representation of each phase of Software Development life cycles.

Diagrams overview:

There are total of 14 diagrams in UML and these diagrams are broadly classified into two main groups

- i. Structure
- ii. Behavior

As shown in Figure 15.1 below:

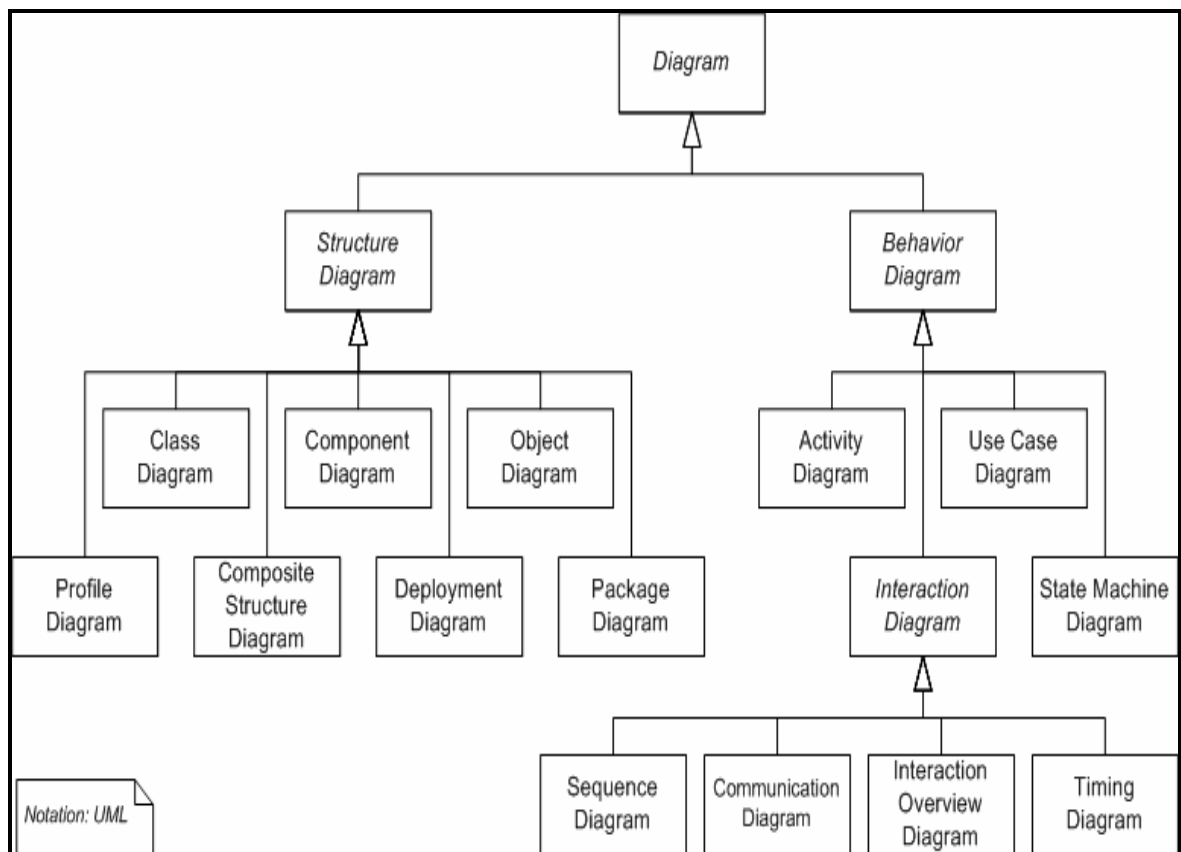

Figure 15.1

As already mention in this chapter, UML provide different viewpoint of same system under consideration, from view point perspective we can divide the diagrams in the UML as shown in Figure 15.1 in 3 main categories:

i. Static

- a. **Use case diagram**
- b. **Class diagram**

ii. Dynamic

- a. **Activity diagram**
- b. **Sequence diagram**
- c. Object diagram
- d. State diagram
- e. Collaboration diagram

iii. Implementation

- a. Component diagram
- b. **Deployment diagram**

Note: In this course as our main focus is not on UML diagrams, we are recapping the important diagrams which are required in coming lectures. Hence we will be discussing required diagrams (Diagrams in BOLD above) only for this course.

i. Static Diagrams:

a. Use Case Diagram (UCD):

In object oriented analysis and design methodology, UCD form the basis for identification and documentation of requirement gathering phase in a procedural and graphical way. This diagrams tends to represent the system holistically in a graphical way to represent the functional aspect of the system along with functional users. For larger systems UCD consists of multiple use cases, each use case usually represents a specific process of the system. Use cases form the base line data of “**Requirement Specification (RS)**” document and for other diagrams to be discussed later in the course. For tracking purposes each use case is given a use case number and depending upon the template for RS generation different parameters about use case is stored. For example commonly used RS templates are **Volere Template or IEEE Requirement specification template**; and there are many more, large organizations usually have their own RS template. The point which is to be discussed is that Use Cases form part of RS documents by identifying Functional aspects in graphical and traceable form with each use case is usually assigned a unique use case number and depending on RS template other relevant information is captured and stored in a common repository for the project team to access.

Basic Concepts in Use Case Diagram:

i. Actor

An Actor is a role usually outside the boundary of a system that interacts directly with it as part of a coherent work unit (a use case) of the system .One physical object (or class) may play several different roles and be modeled by several actors. From this point one should not one assume that Actors are humans and that misconception is natural by its naming convention. Actor is any initiating entity to start the process. For example in Heat sensor system, sensors are actors that can initiate a reaction. Actors are those roles which we can responsible for generating reaction from the process within the system. There are cases when actors can belong within the existing system.

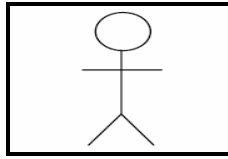
Notation to Represent an Actor:**ii. Use Case**

These are the actions which are initiated by the actor for a particular process to be completed. Each action correspond to one or single actor and vice – versa. We cannot make it as a rule that an actor can initiate only one action. The main goal is to complete the processes under consideration and there can be single step or multi-steps to complete a particular process. One use case represents complete steps that are required for a particular process to be completed.

Notation to Represent a Use Case:

Use case is represented by an Oval shape with the name of the step of the process which complete a particular process

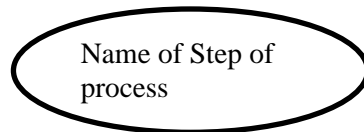

iii. Relationships:

There are relationships that exist between actors and use cases or both

a. Include

When multiple use cases share same functionality then it is logical that rather than writing the same functionality again and again, we can use the concept of re-usability to write the common functionality once and include it as a part of required use case. One use case will use the services of another use case. It is like the concept of Functions or Subroutines in the programming. The base use cases are, in a sense, incomplete without the included use case. Without adding the functionality of the common use case base use cases cannot complete its process. It is represented by drawing a dotted directed arrow pointing towards the included use case from **all** the use cases that include it.

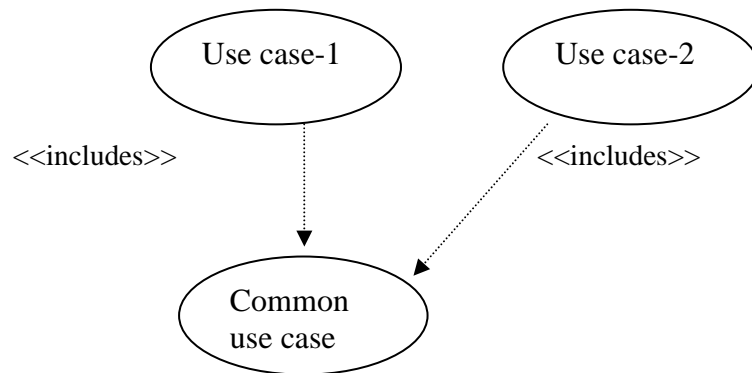

b. Extends

A significant alternative course of action exists within the use case. A use case may extend a use case by adding new actions to the base use case. Typically used when there are important, optional variations on the basic theme of the base use case. The base use case is complete in and of itself. Extends relationship is dependent on the base use case for its existence. We can say that extends is an additional which can be used to supplement the basic functionality to fine tune the process. The flow of the

extending use case is only included under specific conditions, which must be specified as the extension point of the use case being extended. Extends relationship

is shown by using directed arrows which should point towards the use case(s) being extended (and not the extending use case i-e use case).

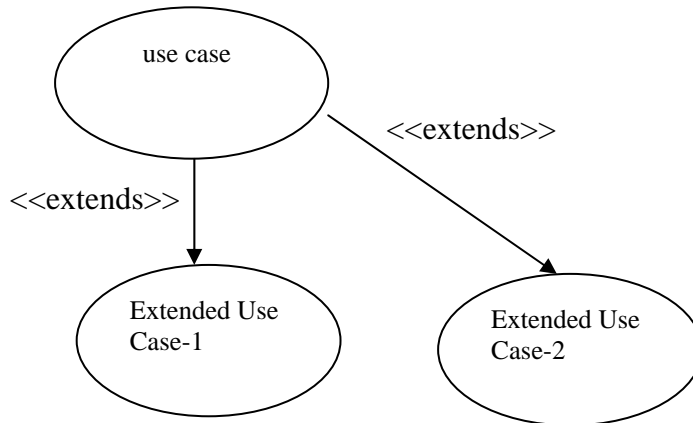

After having discussion on the concepts which are required to generate a use case let us discuss a complete scenario where these concepts can be applied.

c. Generalization

A parent use case may be specialized into one or more child use cases that represent more specific forms of the parent. Neither parent nor child is necessarily abstract, although the parent in most cases is abstract. A child inherits all structure, behavior, and relationships of the parent. Children of the same parent are all specializations of the parent. This is generalization as applicable to use cases. Generalization is used when you find two or more use cases that have commonalities in behavior, structure, and purpose. When this happens, you can describe the shared parts in a new, often abstract, use case that is then specialized by child use cases as shown in the diagram below:

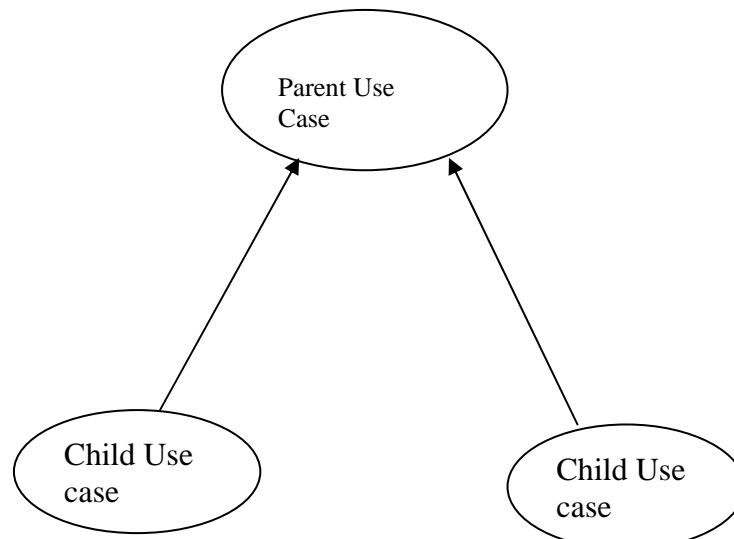

Things to avoid while identifying Use Cases:

A classic mistake made at this early stage of design is to go into technical detail and commit to a specific user interface design or implementation technology. This is almost always the wrong time to be making these kinds of low-level design decisions. We first need to understand what the business logic of the interactions is, so we can focus on satisfying the business goal of the use case. Essential use cases are a great technique for describing interactions in a way that is independent of the technical implementation of the system

Scenario - 1:

For running an online store which contain different products several activities are taking place in parallel to maintain, update and be competitive in the market with the help of effort of multiple departments. Marketing staff can setup the promotional list of items; maintain the catalogue of products whose promotion is to be emailed to the customers of the company. Sales staff processes the order and in check the availability of the product in the current stock and also handles the products which are returned by the customer either for repair or replacement. The online store has an agreement with the courier company which collect the items to be delivered and in special cases also deliver gift items to the clients. The process of placing the order by the **customer** can perform the following steps under normal situation:

1. Customer enter login information
2. System display product menu
3. Customer add items to shopping cart
4. System display message indicate the item added to shopping cart
5. Customer proceed to checkout
6. System ask user provide shipping and billing information
7. Customer provide shipping and billing information
8. System confirm the shipping information, process the order and ship out the items
9. Customer receive the items

Task to do:

- **To Generate 2 possible use case diagrams. One possible solution is given below:**

One Possible Solution:

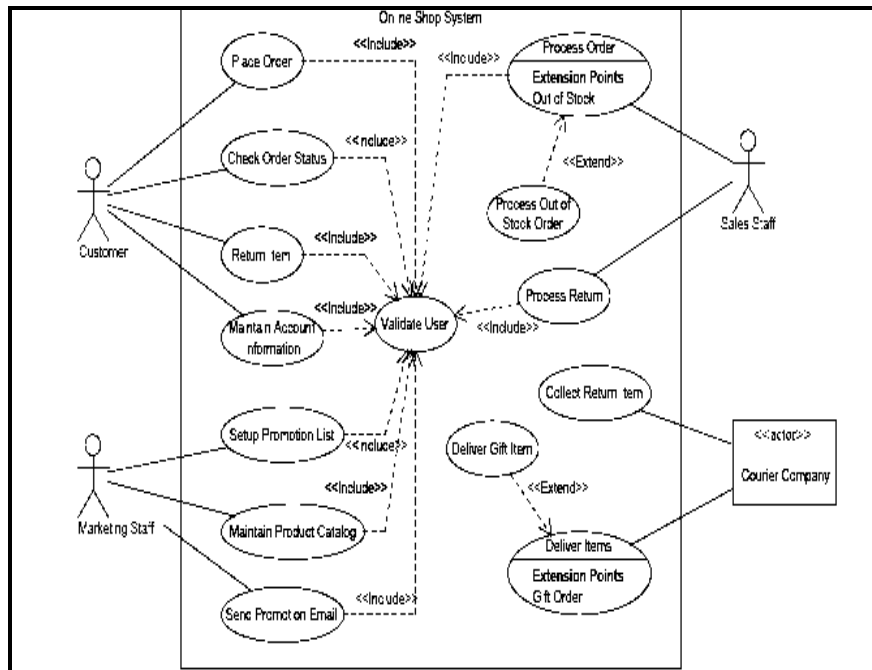

Scenario -2:

Look at the diagram below, I have shown two use cases i-e **Check out Option** and **Review a product**. Use in a online store can check out after completing shopping or review a particular products but at certain point during that process in both the situations user is prompted to login to proceed further, a condition is added to proceed further to complete the processes. In the diagram below I have shown the brackets in both the use cases which are showing common steps in both the use cases but at the end of both the use cases they are required to login to proceed further.

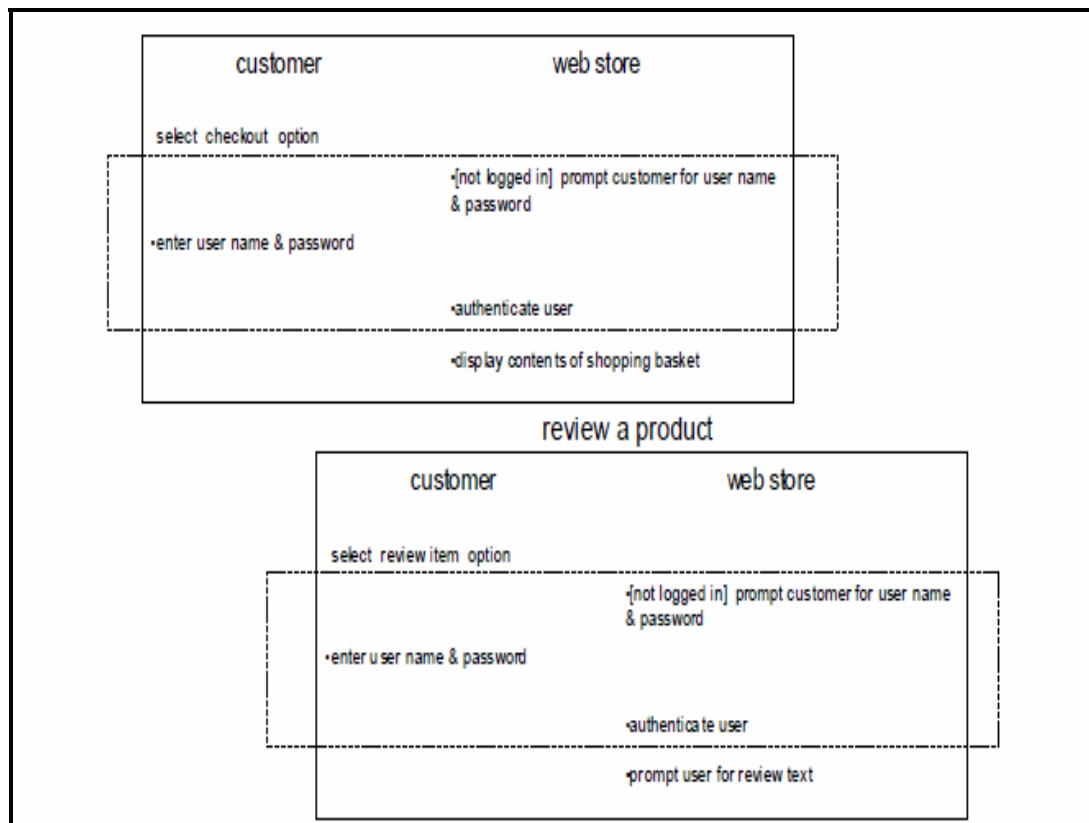

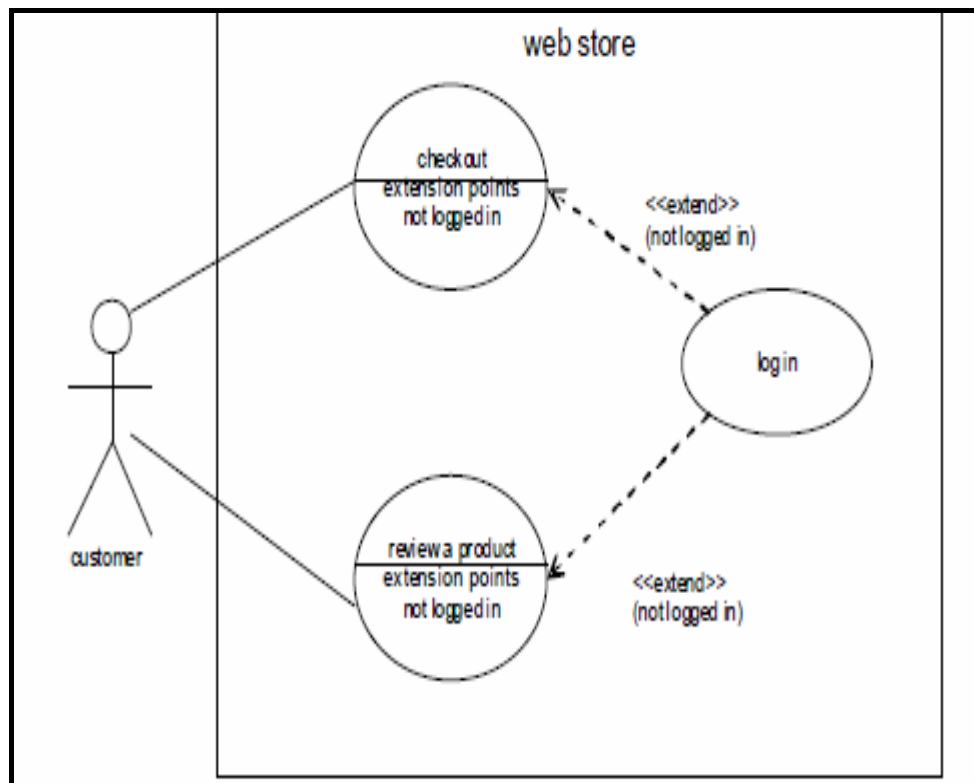
Possible Solution:**Task to Do:**

- **Generate 2 other alternate solutions of the above scenario.**

LECTURE NO: 16

Objectives:

We will discuss the structure of class diagram, its components, relationship types that exists in class diagram and we will cover association relationship with help of comprehensive examples for each concept.

b. Class Diagram

This diagram is the next diagram in sequence of static category of UML diagrams. This diagram derives its existence and functionality from Use Case Diagram. This is a static structure diagram that shows the classes, attributes and methods along their relationships. From this diagram we are a step closer toward implementation as compare to UCD. From this diagram code will be generated beside other classes of the respective framework if needed. There can be multiple versions of class diagram during brain storming sessions but there will be only one final diagram of a particular system against requirements which will be implemented, I mean to say that it is not possible that we have multiple final versions of class diagrams to be implemented. Each class will be accessed via it's object which will actually exist in the memory for the user to access a particular class, mechanism to access the class diagram may differ in different programming language but class diagram will remain same so we are having discussion without considering any technology aspect and as a reminder if you will start thinking that you are implementing it in parallel then it will be counterproductive to understand the concepts of class diagram.

Basic Concepts in Class Diagram

i. Class Structure

Class acts like a template (specification, blueprint) for a collection of objects that share a common set of attributes and operations. It is a central modeling technique which shows the various kinds of objects and their static relationships. It is considered to be the richest notation oriented diagram in UML.

Class basically contains attributes (properties) and methods (Operations) that can be applied on these attributes. Hence class is a combination of properties and processing (business logic). The UML representation of a class is a rectangle containing three compartments stacked vertically, as shown in the Figure below.

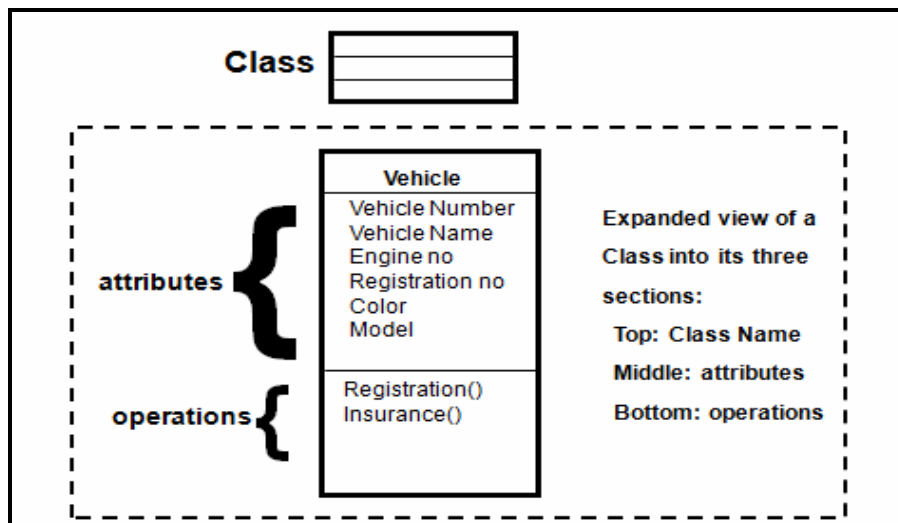

Ways to identify Classes:

Do the **Noun Analysis**: Go through the problem statement again and again and try to figure out all the nouns that you come across. In our case some strong contenders for the classes of the library management system would

Class Object:

Class is structure which exists and can be accessed by declaring its objects or references by allocating memory to the class. The size of the object depends on the attributes defined in the class because object is just like a pointer which points to the memory location where class is loaded to be accessed by the objects.

LECTURE NO: 17

Objective:

This lecture will be a continuation of the contents of the previous lectures, in this lecture we will discuss different types of relationships that exist between classes and how these relationships have impact on the interaction among classes.

Relationships among classes

After having discussion on the basic structural issues of class diagram, now let us discuss the interaction issues that exist between different classes of same class diagram. Interaction among classes exists by the identification of the type of relationships between the classes. Classes don't work in isolation, they work in conjunction with other classes to re-use the functionality of the other classes. Mainly there are 4 types of relationships that exist between classes of class diagram as following:

- i. Association**
- ii. Aggregation**
- iii. Composition**
- iv. Inheritance (Generalization / Specialization)**

In this lecture we will discuss Association relationship in detail with the help of examples and sample scenario. Due to the importance of these concepts intentionally I am spending more time on these concepts because these will form the base for the coming contents later in the course.

It is pertinent to mention here that identification of classes, relationships among classes is dependent on the requirements of the system under consideration so we have to identify the classes and their relationship to full-fill the requirements of the “**system strictly**” otherwise every

class will have relationship with every other class because at the end of the day all the classes are representing the same system.

i. **Association:**

This is a basic relationship that exists between classes; it is a structural relationship which represents a binary relationship between objects. Associations are bi-directional i-e both classes are involved in a relationship or uni-directional. The bi-directional association relationship is shown by a line between two classes with a name of relationship on the line as shown below:

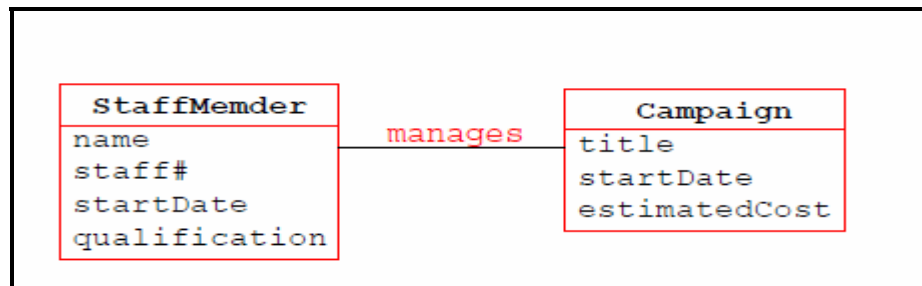

Now the diagram above reflects the basic type of association that exists between Staff member and Campaign class and it is a representation of bi-directional association between participating classes. Both classes are aware of this relationship among them.

Uni-Direction Association:

At time we need to mention the direction of the association that exists between classes because we want to retrieve the value of class which is based on the value from another class. For example, given a person's full name, you can get the person's telephone number, but not the other way around. This mean one class is aware of the relationship but other class is not aware of this relationship. Uni-direction association is shown by drawing a directed arrow from known class to unknown class. In the diagram below PersonName class know about Telephone# class but not the other way around.

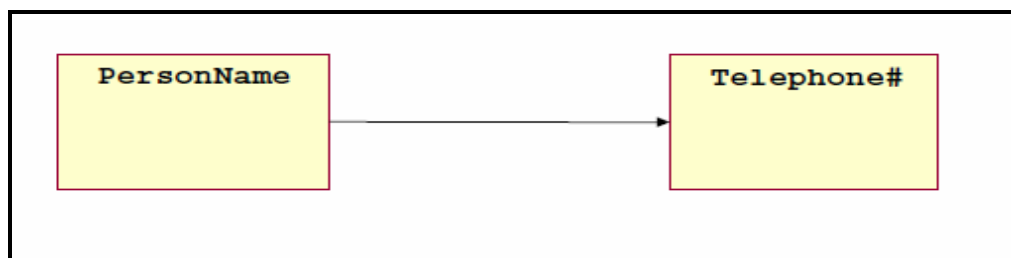

Multiplicity:

It is the identification of the fact that how many instance(s) of a class can be initiated against other class which is participating in the relationship; hence it represent cardinality of the class in relationship to another class. It represent business constraint which will be implemented in the software. There are multiple types of multiplicity values that can be associated with the association, some of the commonly used types are shown below:

- Optional (0 or 1)= 0..1
- Exactly one = 1..1
- Zero or more =0..*
- One or more =1..*
- A range of values= 1..6
- A set of ranges =1..3,7..10,15,19..*

This concept is mostly not discussed in books and at times it is misunderstood due to lack of depth we will try to address this issue.

In bi-directional association, relationship are also read and written in bi-directional way as shown in the diagram below:

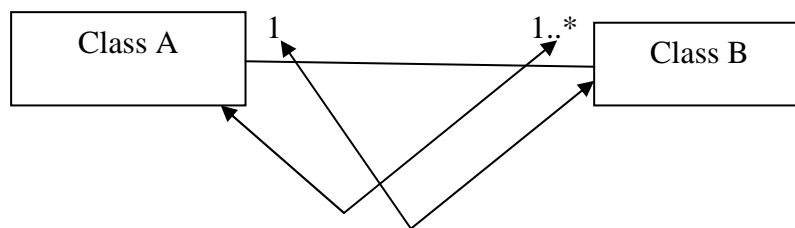

Rules to Read / write an Association:

- Association # 1: Relationship from Class A to B
- Association # 2: Relationship from Class B to A
- Combination of Association 1 and Association 2 completes an Association.

Another very important point to remember is that multiplicity is always written for a particular class (Class A) from the line emerging from opposite class (Class B)

Multiplicity 1 emerging from Class A is actually representing multiplicity of Class B and multiplicity 1...* emerging from Class B is actually representing multiplicity of Class A

Now we read the bi-directional association of the given above sample diagram:

Association # 1 (From A to B): Class A is having one or more (1...*) instance of B

Association # 2 (From B to A): Class B is having exactly one (1) instance of A

Another Example:

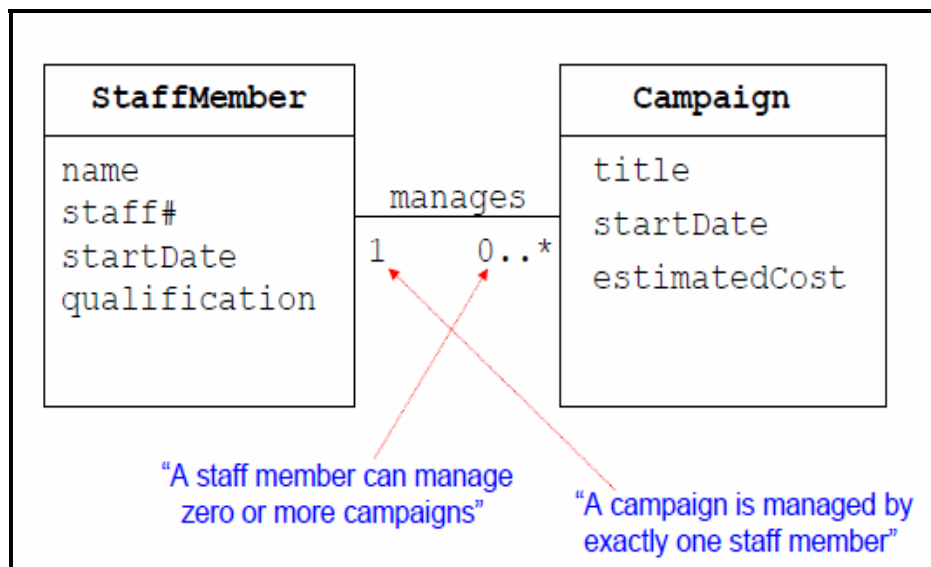

Tasks to Do:

- i. Write Association for the diagram given below:



- ii. Generate Use Case Diagram of the Class diagram given below:

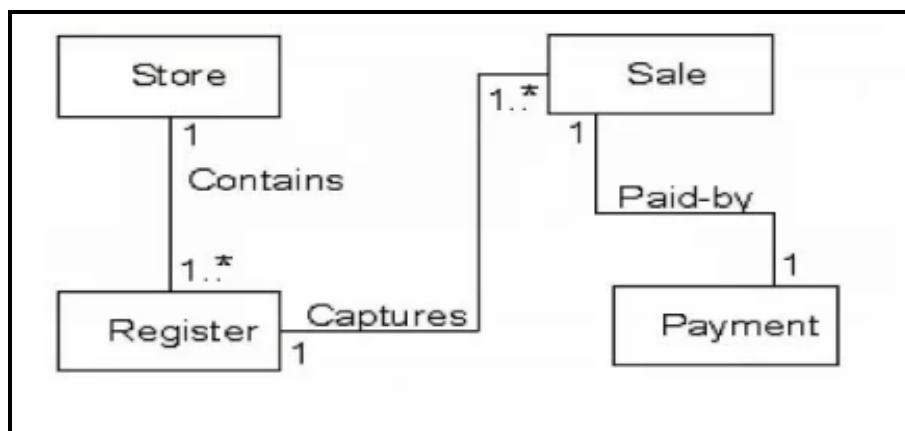

LECTURE NO: 18 && 19

Objective:

This lecture will be a continuation of the contents of the previous lectures; in this chapter we will cover the contents of 2 lectures (18 && 19) because we will be discussing aggregation, composition associations in class diagram and it will be very constructive if we discuss them in comparison with each other. Each concept will be supported by example or scenario.

i. Aggregation or “Has a “ Relationship:

Aggregation is a specialized form of association i-e Weak Association; in which a particular class diagram is creating by assembling classes. Aggregation is a special type of relationship used to model a "whole to its parts" relationship. An association in which one class belongs to a collection of classes

Whole-to-Part Relationship

In “Whole/part “relationship, where one object is the “whole”, and the other (on of) the part(s)”. Part class is independent from the whole class’s lifecycle, this mean that we construct a class diagram by using existing class but the existence of both the participating classes in the relationship don’t have any sort dependence on each other individual existence. Whole class has its own identity so does the part class. In an aggregation relationship, the child class instance can outlive its parent class. Part class can be a part of multiple whole classes.

Representing “Whole /Part” relationship:

To represent an aggregation relationship, you draw a solid line from the parent class to the part class, and draw an unfilled diamond shape on the parent class's association end as shown below:

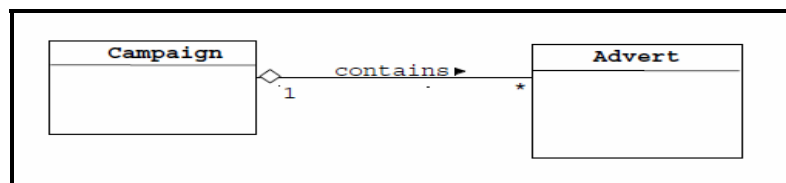

The diagram above shows that a campaign contains advertisements but the existence of advertisements is not necessary for the campaign, advert has their own existence which means they don't have a dependency relationship among them. As discussed advert can have a different nature of relationship with another separate class. Here we also observe in the class diagram that there is association also between two classes' i-e 1 to Many (*); which implies association and aggregation can also co-exist in the same relationship there is no binding on it.

Another Example:

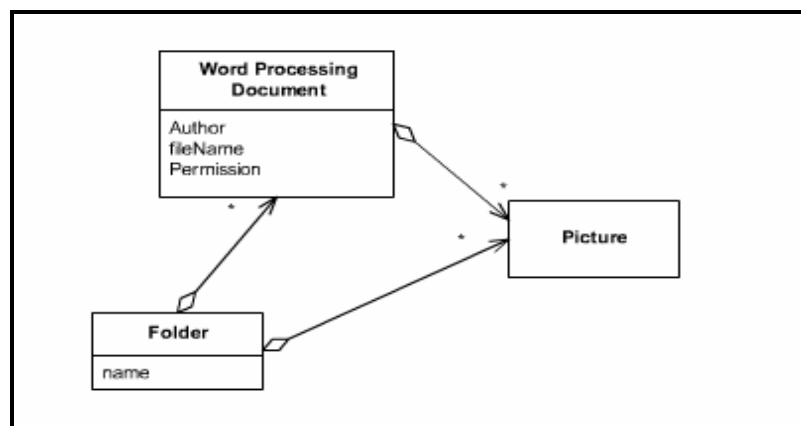

This diagram shows association and aggregation between more than 2 classes (at a time 2 classes). Pictures belongs to folder but it is not necessary that picture should be contain inside a folder they can also exist on the root like c:\ that's why the association between them is aggregation and same is true with picture to Word processing documents association.

Another Example

A catalogue object is a collection (**aggregation**) that consists of many product objects. However, any particular product may appear in more than one catalogue. This is the case where part class can belong to another whole class or have relationship with another class.

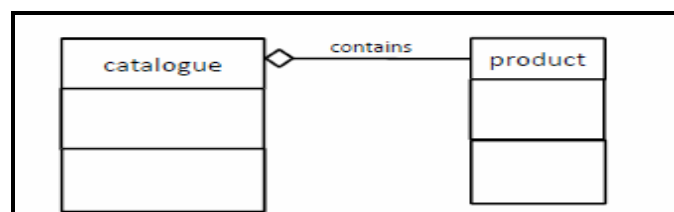

ii. Composition:

A composition relationship implies strong ownership of the part and the whole. Also implies that if the whole is removed from the model, so is the part. It's a strong association. It contains Objects that live and die together. The composition aggregation relationship is just another form of the aggregation relationship, but the child class's instance lifecycle is dependent on the parent class's instance lifecycle. In a composition relationship, the whole is responsible for the disposition of its parts, i.e. the composite must manage the creation and destruction of its parts. As opposite to Aggregation the existence of part class is only possible with existence of whole class. Another difference is that part classes strictly belong to only one parent class. For example **heart belong to only one human body**

Representing Composition relationship:

It is represented by a filled diamond shape from child to parent class with association

Example -1:

In the example given below, building consists of room where building is acting like whole class and room is a part class and they are having composition relationship which mean if building is destroyed then rooms will automatically be destroyed and rooms can't exists independently they must belong to a building, so it would be wrong if we create aggregate relationship between two classes.



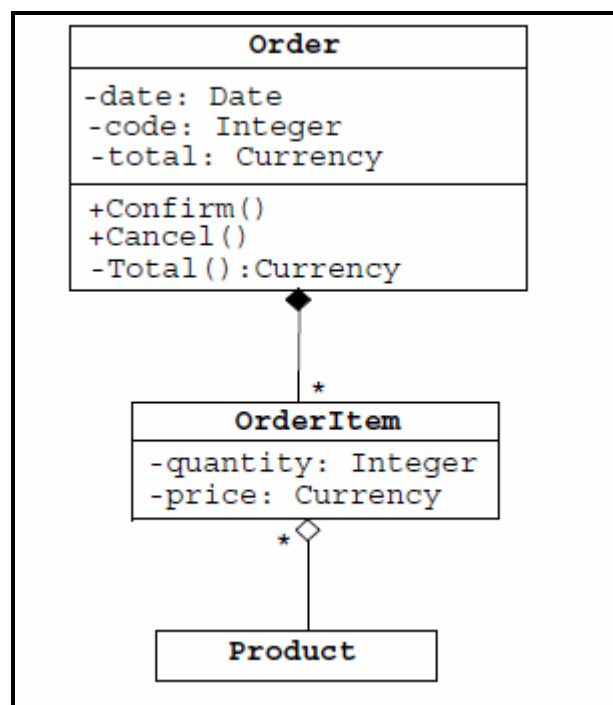

Example -2:

Consider the class diagram given below where order is placed and it contain different order items (order details), each order detail is having product but every product will not be a part of order item but for order item to exist it should have an order for it. So the relationship between order and order item is of composition but between order item and product is aggregation.

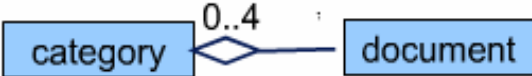

After having a discussion on composition and aggregation in detail let us compare them by using following table.

Aggregation	Composition
Part can be shared by several wholes 	Part is always a part of a single whole 
Parts can live independently (i.e., whole cardinality can be 0..*)	Parts exist only as part of the whole. When the whole is destroyed, they are destroyed
Whole is not solely responsible for the object	Whole is responsible and should create/destroy the objects

Tasks to do:

- i. Complete the following class diagram by creating appropriate relationships between person-to-car, engine-to-car, person-to-Train, engine -to train, write justification for your answer because just as a practice for exams, answer without justification will not be considered to be true.

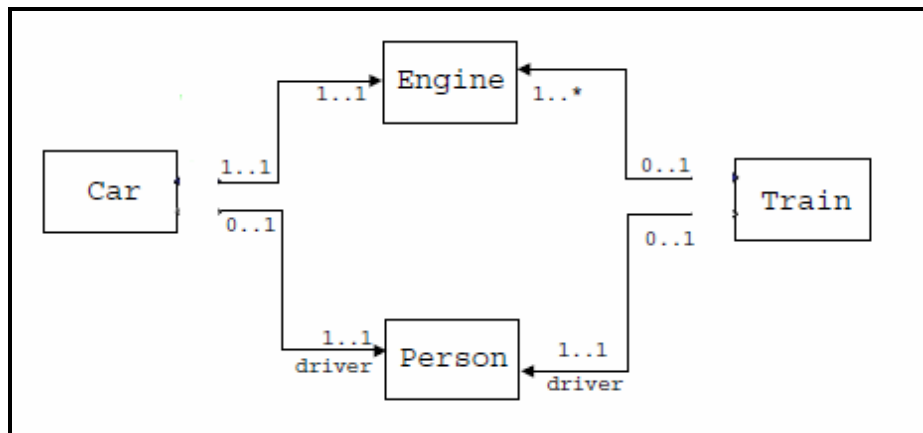

LECTURE NO: 20

Objective:

This lecture will be a continuation of the contents of the previous lectures; in this lecture we will discuss the concept of Inheritance (Generalization and Specialization) in detail in class diagram. Each concept will be supported by example or scenario.

Inheritance (Generalization / Specialization)

This is a last type of main relationships that exists between classes of class diagrams. This relationship represents parent /child or super type / sub type relationship in which all the attributes and operations of super class (as per accessibility level discussed in previous lecture) are available to be used by all the sub classes. The child always inherits the structure and behavior of the parent. However, the child may also add new structure and behavior, or may modify the behavior of the parent (by using overriding). At times we are faced with a situation where there are multiple classes having some common attributes or methods among them and some different attributes or methods, in such a situation rather than repeating the common behavior we define common attributes and methods in super class and sub class can inherit them but we have to keep this thing in mind that it should not be the case that sub type don't have which is not common among other sub types. Specific attributes / methods for sub class should exist also. The super class which is having generic or common behavior to be inherited by its sub classes is known as **“Generalization”** and sub classes having sub class specific attributes / methods is known as **“Specialization”**

Notation to Represent Inheritance:

The triangle linking the classes shows inheritance; the connecting line between AdminStaff and CreativeStaff indicates that they are **“mutually exclusive”** i-e Staff member can either be Admin staff or Creative Staff but strictly not the both. However, all instances of AdminStaff and CreativeStaff will have a staff#,name, startDate, while CreativeStaff will also have a qualification attribute.

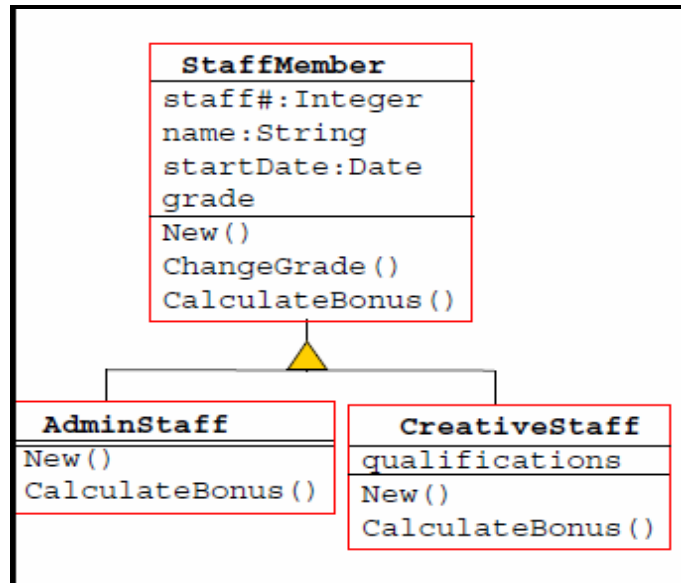

Similarly, the operation `CalculateBonus ()` is declared in `StaffMember`, but is overridden in each of its sub-classes.

- For `AdminStaff`, the method uses data from `StaffGrade` to find out the salary rate and calculate the bonus.
- In the case of `CreativeStaff`, it uses data from the campaigns that the member of staff has worked on to calculate the bonus.

Finding Inheritance:

It is very important to understand the way to find inheritance, at times it is very clear from the given scenario but at times it is in abstract form we need to explicitly find it. There is not hard and fast rules to identify and finding inheritance except practice but broadly speaking we can divide of this into two main categories:

- i. **Top-Down**
- ii. **Bottom-up**

- i. **Top-down:** we have a class, and we realize that we need to break it down into subclasses which have different attributes and operations.

From the class diagram below it seems that there is no need to break the advertisements (Advert) but when we perform a analysis then we find out that there are multiple types of adverts each having its own properties methods and here we find out 2nd level of inheritance between Press Advert is having 2 child which i-e Press advert; is a child by itself.

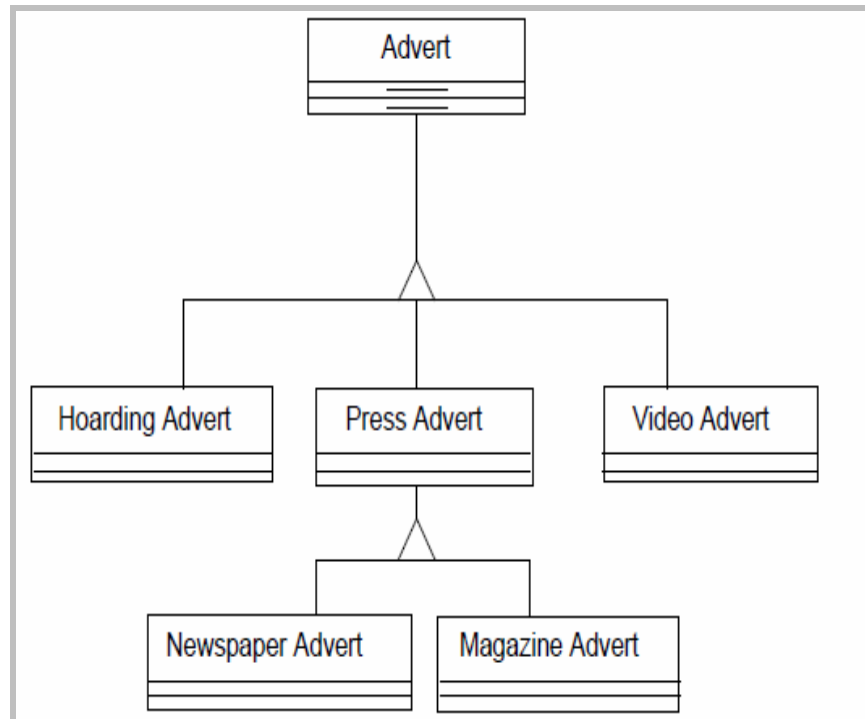

- ii. **Bottom-up:** we have several classes and we realize that they have attributes and operations in common, so we group those attributes and operations together in a common super-class. As shown below we have 2 separate classes having some attributes and methods in common, the class diagram before inheritance is as below:

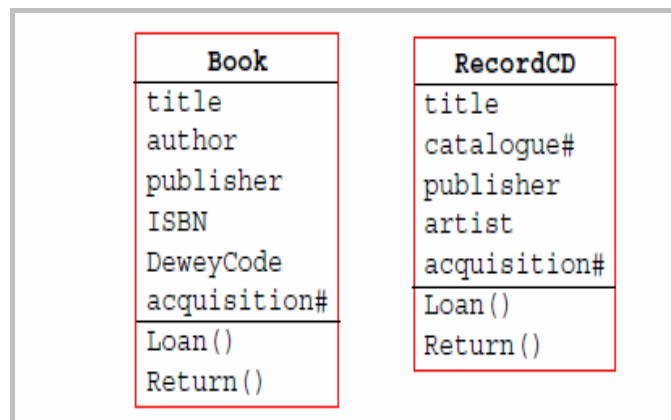

The class diagram after inheritance is shown below which show a common class having common attributes and methods and sub classes are having only specific attributes and subclasses also share attributes and method of super class i-e Loan Item.

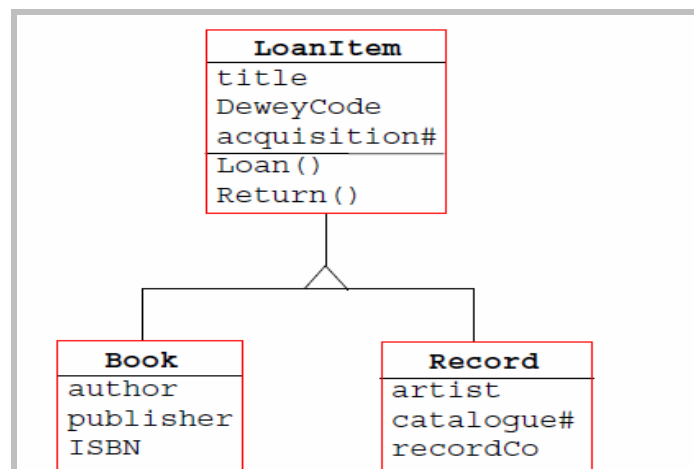

LECTURE NO: 21

Objective:

This lecture will provide multiple sample scenario's and solution of each scenario will be discussed during the lecture because all the concepts which are discussed in the previous lectures regarding class diagrams need practice using sample scenario's.

Scenario # 1:

- i. Suppose that you're writing a document in some of famous text processing tools, like Microsoft Word for example. You can start typing a new document, or open an existing one. You type a text by using your keyboard.
- ii. Every document consists of several pages, and every page consists of header, document's body or/and footer. In header and footer you may add date, time, page number, file location e.t.c
- iii. Document's body has sentences. Sentences are made up of words and punctual signs. Words consists of letters, numbers and/or special characters. Also in the text you may insert pictures and tables. Table consists of rows and columns. Every cell from table may hold up text or pictures.
- iv. After finishing the document, user can choose to save or to print the document.

Developing a Solution:

i. Extracting keywords from the scenario

document, **text processing tool**, **MicrosoftWord**, text, keyboard, header, footer, **document's body**, date, time, page number, location of file, page, sentence, word, punctual sign, letter, number, special character, picture, table, row, column, cell, user

- **Keywords in bold are candidate attributes, rest are nouns and are potential classes.**

ii. Develop class structures (attributes and operations)

a. Document Class

A document will be the central class in our class diagram. Document has a several pages; therefore a **numberOfPages** will be one of the attributes for the **Document class**. For the operations we have: **open ()**, **save ()**, **print ()** and **new ()**. Every document consists of pages. The **Page** will be also a candidate for the class.

Document
numberOfPages
open() save() print() new()

b. Page Class

The **Page** class will hold *pageNumber* as an attribute, and operations allowed here can be: *newPage ()*, *hideHeader ()* and *hideFooter ()*.

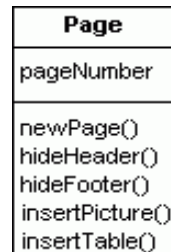

c. BottomUp Class

This class contains **Header and Footer Classes**, the Header class and the Footer class have common attributes:

- I. *date, time, pageNumber* and *fileLocation*. These attributes are optional for every header or footer and user may configure them. This will guide us that a common class can be introduced. This will be a good time to make an inheritance.
- II. Parent class will be BottomUp (this name is chosen because headers and footer appear in upper and bottom parts of every page) and will hold common attributes for header and footer, and these operations: *display ()*, *hide ()* and *change ()*. Header and Footer classes (children of this class) will have only operations: *newHeader ()* and *newFooter ()*.

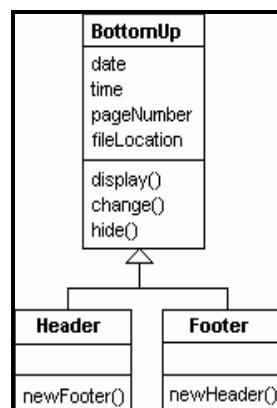

d. Table Class

The **Table** class has *numbRows* and *numbColumns* as attributes and *newRow ()*, *newColumn ()* and *newTable ()* as operations. Every table consists of one or more cells. And in every cell, text or pictures can be placed.

Analysis of the document

Document's text is made up of sentences. Sentences are made up of words and words are made up of characters. If words are array of characters and sentence is array of words, then a sentence is also an array of characters. Therefore a document's body can be an array of characters. For this purpose to make a document's text we'll use the Character class with its children. The **Character** class will have *ASCIIcode* and *type* as attributes (type tells the type of the character - normal, italic, bold or underline), and *normal ()*, *bold()*, *italic()* and *underline()* as operations. The character class childrens will be: **Letter**, **PunctualSign**, **SpecialCharacter** and **Number**.

In the document's body there can be found tables and pictures. These are new classes in our class diagram.

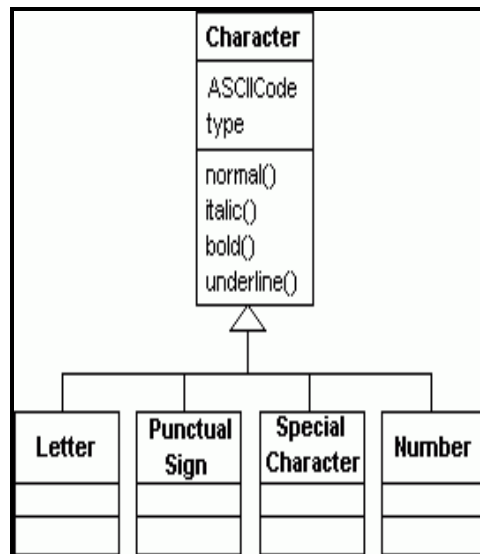

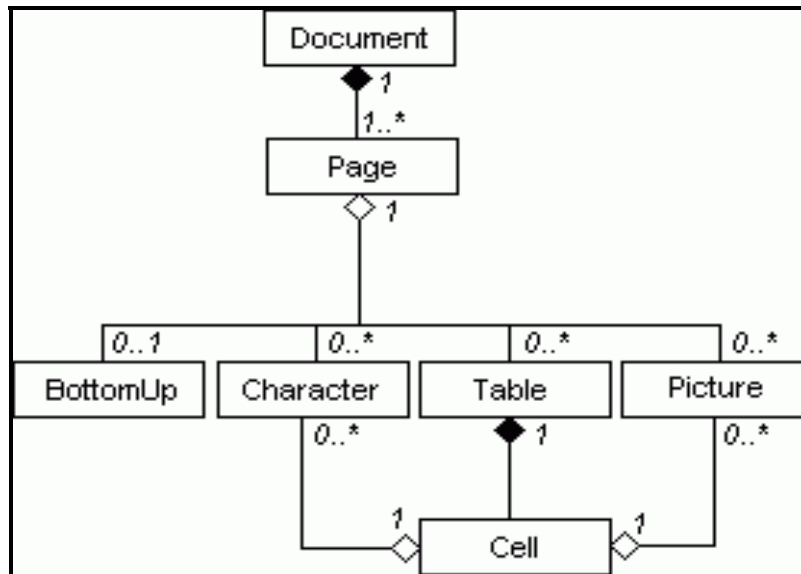
Proposed Solution:

Scenario # 2:

- i. We need to design a system to handle the world cup where there are multiple teams and each team is having 11 players.
- ii. Each team represents a country of its belonging.
- iii. Countries qualify from zone, where each zone is having one or more countries in it.
- iv. Each team is given a number of games in a specific city.
- v. Referees are assigned to games.
- vi. Hotel reservations are made in the city where teams play the game

Proposed Solution

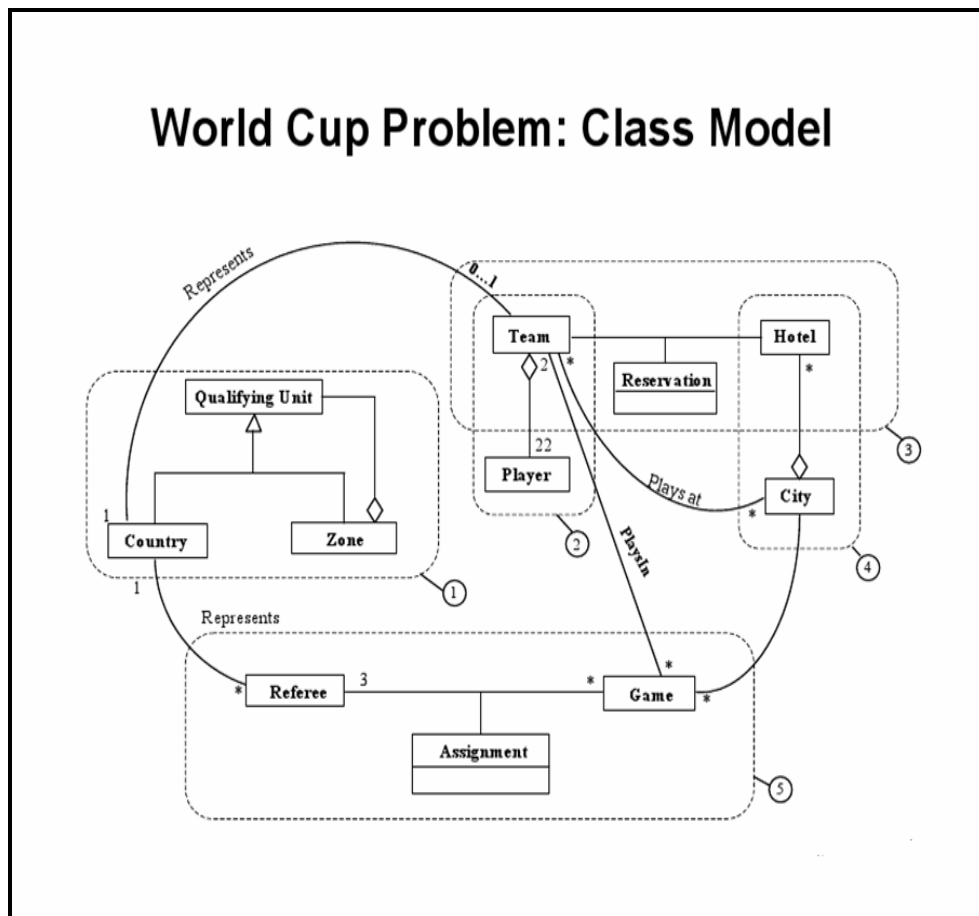

LECTURE NO: 22 && 23

Objective:

We will cover contents of two lectures in one chapter as these two lectures will be discussing Activity diagram. We will discuss Dynamic Category of UML specifically Activity diagrams with its notations in detail and at the end we will discuss a comprehensive example to understand the concepts discussed.

Activity Diagram:

Activity diagram belongs to the dynamic category of the UML diagrams, as the category suggest, this diagram shows variation in the behavior of the system as it changes its state from one to another. Typically activity diagram can be mapped with use cases because use cases shows interactions between different processes and activity diagram can represents the logic of use case. It can be discussed in conjunction with use case but due to different category I am intentionally discussing it after class diagram. To show the logic of the process in step-wise manner activity diagram can be very helpful. One activity diagram can be associated with one or multiple use case(s). An activity diagram usually shows a business process or a software process as a flow of work through a series of actions. People, software components, or computers can perform these actions. In its basic form, an activity diagram is a simple and intuitive illustration of what happens in a workflow, what activities can be done in parallel, and whether there are alternative paths through the workflow.

Notations in Activity Diagram:

As common for most notations, the activity diagram notation has some elements that are necessary for you to understand if you want to be “**conversant**” about activity diagrams. Those elements are presented here. A basic activity diagram can have the following elements:

i. Activity States:

There are two states of the activity one is initial activity shown by filled circle and other final activity shown with a border. Each activity should have one initial state but can have more than one final state. An activity, also known as an activity state, on a UML Activity diagram typically represents the invocation of an operation, a step in a business process, or an entire business process. The rounded rectangles represent activities that occur during the work flows.

ii. Transitions:

Transitions that show what activity state follows after another. This type of transition is sometimes referred to as a completion transition, since it differs from a transition in that it does not require an explicit trigger event; it is triggered by the completion of the activity the activity state represents. In case of transitions from one activity to another activity, directed arrow is used to show the flow within one workflow.

iii. Decisions:

These are like branching situations for which set of guard conditions are defined. These guard conditions control which transition of a set of alternative transitions that follows once the activity has been completed. You may also use the decision icon to show where the threads merge again. Decisions and guard conditions allow you to show alternative threads in the workflow of a business use case.

▪ Branch:

The branch describes what activities will take place based on a set of conditions. It is represented by a diamond with one flow entering and several leaving. The flows leaving include conditions although some modelers will not indicate the conditions if it is obvious. It is like if-then-else in programming language.

▪ Merge:

This type of decision is required when we need to terminate activity of parallel activities; it is shown by a diamond with several flows entering and one leaving. It is represented by a diamond with multiple flows (conditions) entering and there is only one outcome, there is no else part. The implication is that one or more incoming flows must reach this point until processing continues, based on any guards on the outgoing flow.

iv. Synchronization Bars (Fork, Join):

These bars can be used to show parallel subflows. Synchronization bars allow you to show concurrent (parallel) threads in the workflow of a business use case.

- **Join:**

Join Synchronization bar is used when several flows are entering in a process and one is leaving it. All flows going into the join must reach it before processing may continue. This denotes the end of parallel processing.

- **Fork:**

This type of synchronization bar is used when multiple activities are occurring at the same time within a workflow; this is shown with a black bar with one flow going into it and several leaving it. A Fork Should Have a Corresponding Join. In general, for every start (fork) there is an end (join)

All the concepts discussed above are shown below in a sample activity diagram for issuance of boarding pass process is shown with following steps in workflow:

- i. Verification of reservation. If there is not reservation then the workflow is terminated.
- ii. If there is a reservation printing of boarding and checking of baggage activity is initiated but both are independent activities (parallel).
- iii. On successful printing of boarding pass, travel document is given back to the passenger to proceed to the flight.

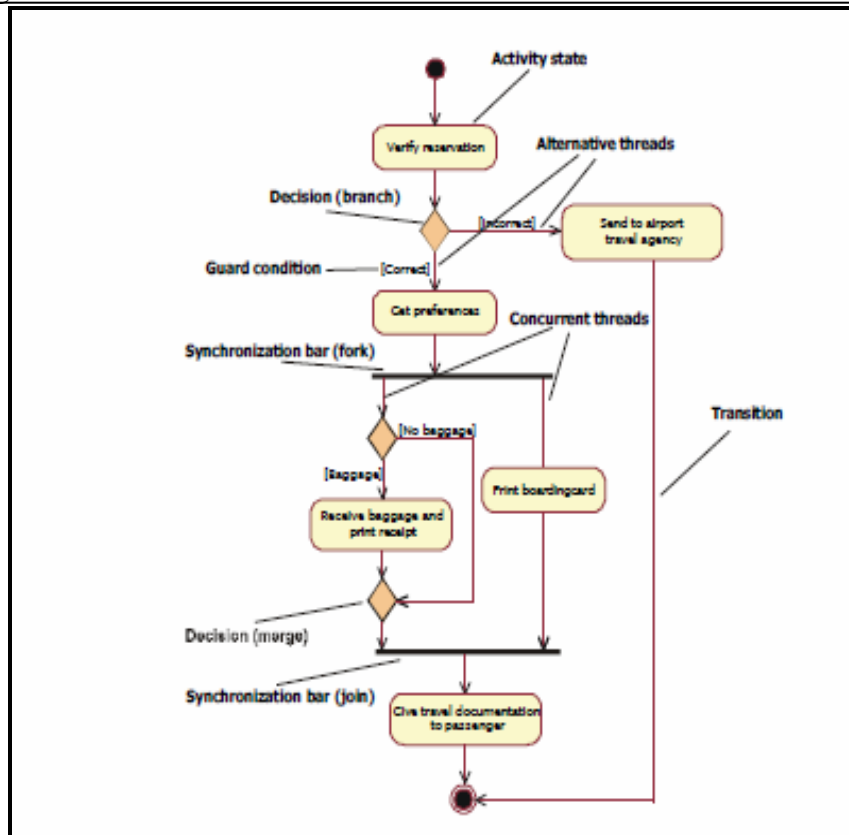

v. SwimLanes (Partitions):

The contents of an activity diagram may be organized into partitions using solid vertical lines. A partition does not have a formal semantic interpretation, but is in business modeling often used to represent an organizational unit of some kind. At times it useful, especially when you are modeling workflows of business processes, to partition the activity states on an activity diagram into groups Each group representing the business organization responsible for those activities. Each group is known as “Swim Lane”. Each action or activity is assigned to one swimlane. Activity flows can cross lanes. Swimlanes do not change ownership hierarchy rather it provide a more clear line of specialized communication. The relative ordering of swimlanes has no semantic significance. There is no significance to the routing of an activity flow path. Parts representing internal behavior can be specified on swimlanes.

Scenario:

There is a software product for which manual activation of trial (provisional) product which was protected by software protection licensing product. Customer has trial product installed and protected with license. At some point customer decides to activate product by requesting

permanent, full product license. There will be an activity which will have to create new product key while at the same time customer could create and deliver C2V file ("computer fingerprint"). Once both product key and C2V file are available to customer service, it could activate product, generate V2C file and deliver it back to the customer. The customer applies license and activates installed trial product to become full product. The activity diagram as shown on next page is generated using swim lanes as shown by vertical lines, three swim lanes are shown i-e Order management, customer service and customer. The rectangle box with some activities is showing additional information.

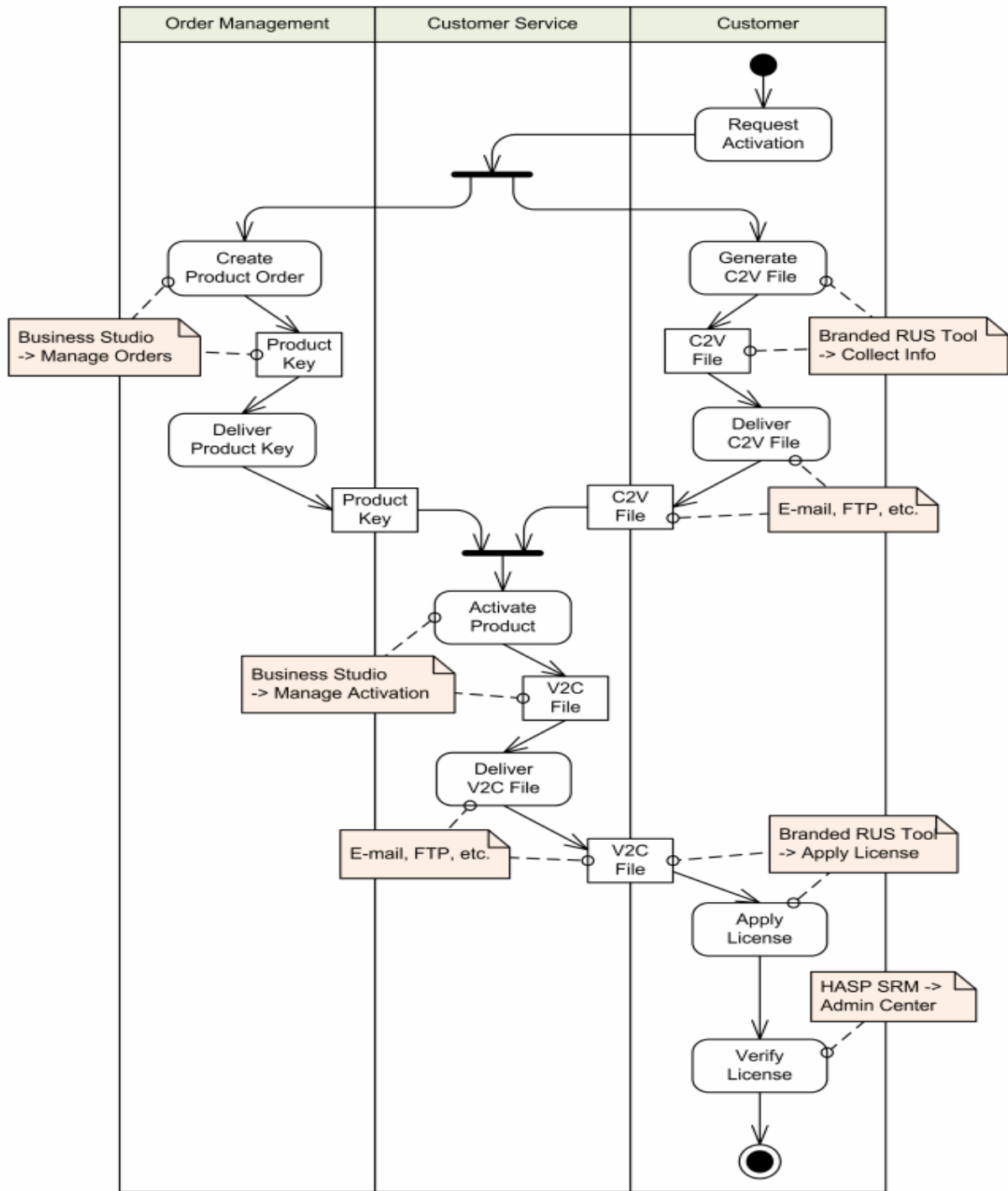

Practice Scenarios:

In a scenario to resolve an issue in software design. This process is very common while during software development and when the software is deployed at the customer premises (service level agreement). Usually tickets are generated for each problem to be fixed, after ticket is created by some authority and the issue is reproduced, issue is identified, resolution is determined, issue is fixed and verified, and ticket is closed, if issue was resolved. This example is not using partitions, so it is not very clear who is responsible to fulfill each specific action.

Possible Solution

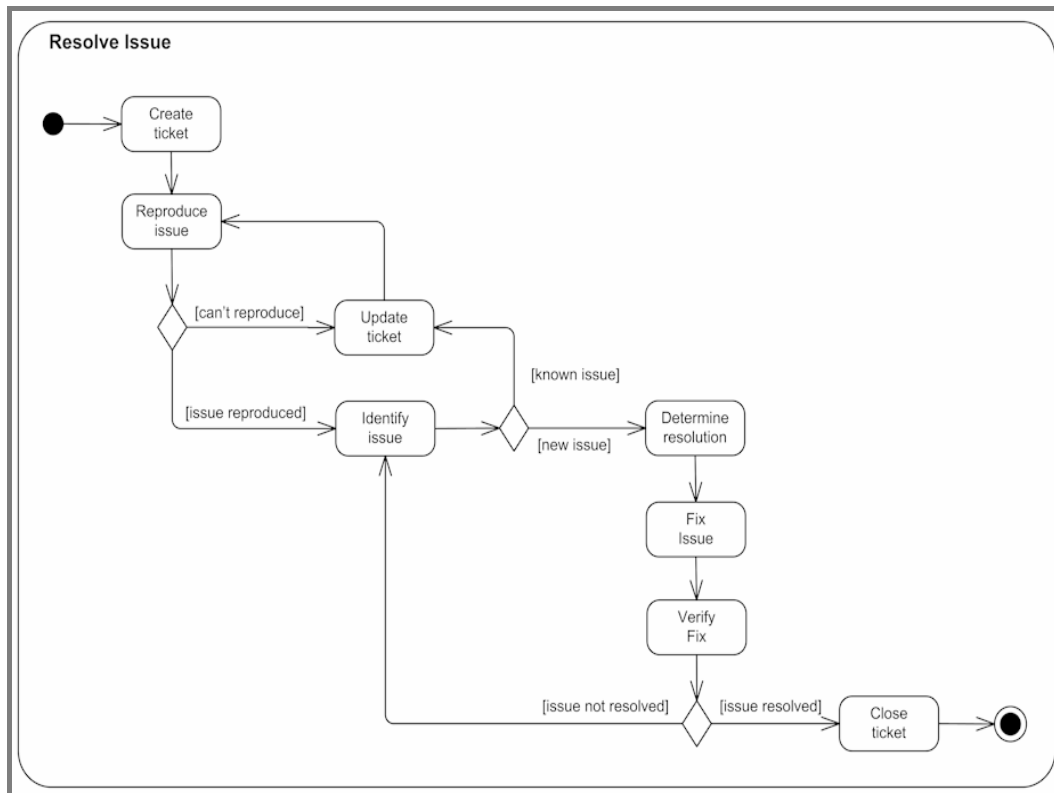

Task to Do:

- Produce another possible Activity diagram of the same scenario.

Task to Do:

You need to draw the activity diagram of the activity describing **Single Sign-On (SSO)** to Google Apps. To interact with partner companies Google uses single sign-on based on OASIS **SAML (Security Assertion Markup Language) 2.0** protocol. Google acts as service provider with services such as Gmail or Start Pages. Partner companies act as identity providers and control user names, passwords, and other information used to identify, authenticate and authorize users for web applications that Google hosts. Each partner provides Google with the URL of its SSO service as well as the public key that Google will use to verify SAML responses. When user attempts to use some hosted Google application, such as Gmail, Google generates a SAML authentication request and sends redirect request back to the user's browser. Redirect points to the specific identity provider. SAML authentication request contains the encoded URL of the Google application that the user is trying to reach. The partner identity provider authenticates the user by either asking for valid login credentials or by checking for its own valid authentication cookies. The partner generates a SAML response and digitally signs it. The response is forwarded to Google's Assertion Consumer Service (ACS). Google's ACS verifies the SAML response using the partner's public key. If the response is valid and user identity was confirmed by identity provider, ACS redirects the user to the destination URL. Otherwise user will see error message.

LECTURE NO: 24 & 25

Objective:

We will cover contents of two lectures in one chapter as these two lectures will be discussing Activity diagram. We will discuss sequence diagram along with its notations in detail with the help of multiple examples. We will also establish the relationship between use case and sequence diagram from Software Design perspective.

Sequence Diagram:

When we are designing real-time software systems, interaction among the classes (objects) that will take place i-e method calling by the object of another class; needed to be simulated before it actually get translated into code. Behavior of the system at the run-time is needed to be captured graphically to show which objects are involved in interaction with which class over the life time of the object because object of a class will be interacting with multiple classes so we need to capture this process. Obviously this interaction among objects is derived from the requirements i-e Use Cases. During the life-time of the object we should have a mechanism which will show the Object interaction in a time-sequence manner. A sequence diagram is an interaction diagram that emphasizes the time ordering of messages. It shows a set of objects and the messages sent and received by those objects. The communication protocol which object follow while communicating with another object can be shown by sequence but the important point is that sequence diagram does not capture a particular instance (only one) communication point rather it show object interaction till it is active or alive in the memory. It is used primarily to design, document and validate the architecture, interfaces and logic of the system by describing the sequence of actions that need to be performed to complete a task or scenario. Sequence diagram is a very useful design tools because it provide a dynamic view of the system behavior which can be difficult to extract from static diagrams or specifications.

Notation:**i. Object:**

Graphically, a sequence diagram is a table (2 dimensions) that shows objects arranged along the X axis (horizontal) and is represented by box with a dashed line descending from it. The line is called the **object lifeline**, and it represents the existence of an object over a period of time, as shown in Figure below.

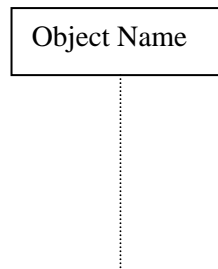

Object name can be represented by Class name: Instance Name, for example Book b but for the sake of simplicity usually class name is optional. If the object is created or destroyed during the period of time then its lifeline starts or stops at the appropriate point; otherwise it goes from the top to the bottom of the diagram. If the object is destroyed during the diagram, then its destruction is marked by a large “**X**”.

Activation of an Object:

Life line of the object represents the existence of an object in the memory but this does not mean that during the existence of an object it is in “**Activation mode**” also i-e interacting with other objects also. Activation (focus of control) shows the period of time during which an object is performing an action either directly or through a message. Activation is shown as a tall thin rectangle whose top is aligned with its initiation time and whose bottom is aligned with its completion time as shown below:

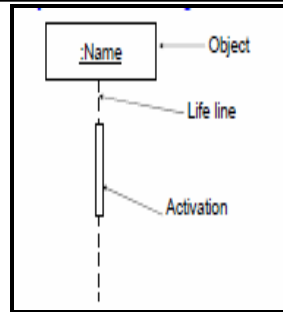

ii. Messages

Messages are shown along Y-axis (Vertical) and are ordered in increasing time. Messages are shown by directed arrow from caller (Object 1) to calling (Object 2) instance as shown below:

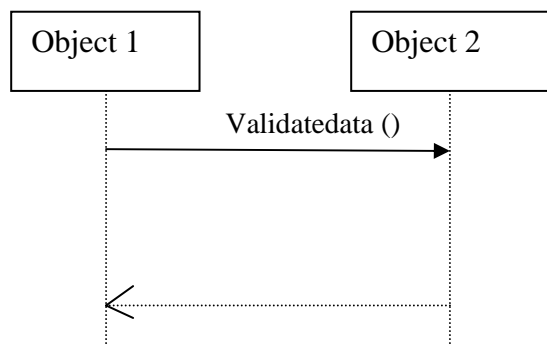

Validate data is the method which exists in class 2 (Object 2) and is accessed by object of class 1 (Object 1), if validate method is returning any value then it is represented by a directed arrow with dashed line as shown in the bottom of the above. There are three types of messages:

i. Synchronous

In this type of message, the object that calls a method or sends a message is blocked or waits for the response from the called object. During the request activation timeline the calling object is in wait state to perform any other task. Synchronous message call is shown by a directed filled arrow with dashed line as shown below:

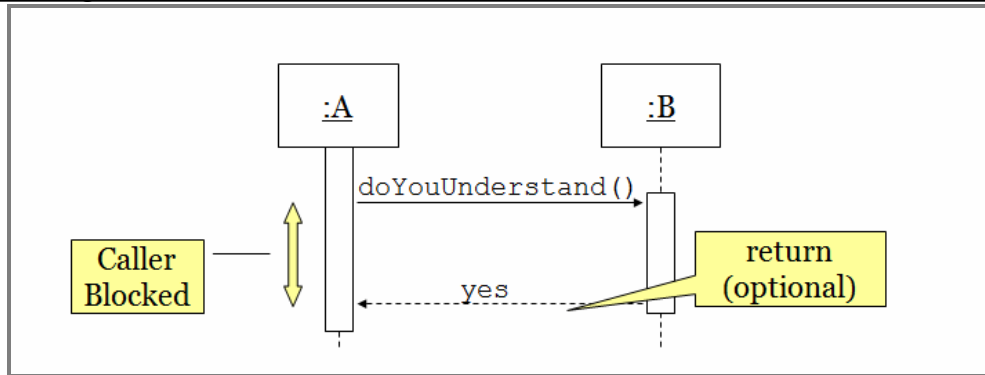

ii. Asynchronous

This type of message is opposite to that of Synchronous message call, in this type of message the flow is not interrupted and response is not awaited i-e caller is not blocked till response and caller can perform any other activity. An asynchronous message is drawn with a half-arrowhead, that (one with only one wing instead of two) as shown below:

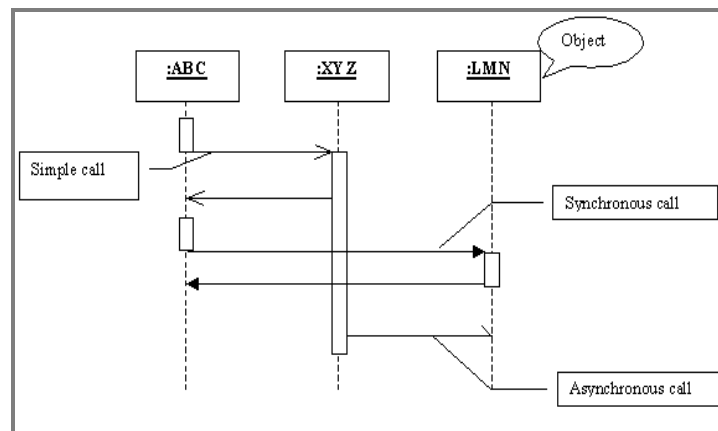

iii. Recursive

Recursive message is like recursion concept in programming language in which there is communication between same message i-e calling and responding message are same. It is like recursion in which within the body of method there is call to itself. The message starts and finish at the same message as shown below:

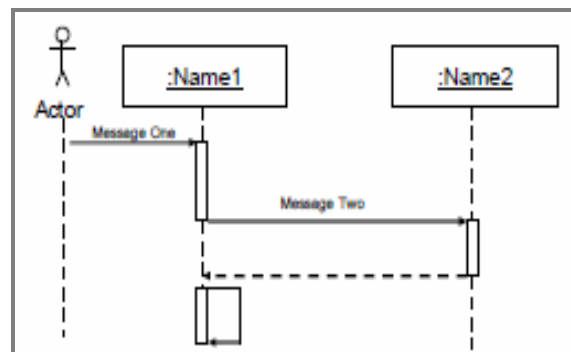

Scenario:

In a telephone call where one caller calls another person, there are series of activities which took place before there is a communication between two parties. First the caller lift the receiver and check the dial tone i-e telephone exchange is working; then caller dial the desired number and then the call is routed through exchange to the receiver having ring simultaneously caller is also listening to the ring which is ringing at the receiver. When phone is picked up by the receiver the ringing tone is stopped and communication begins between communicating parties.

Task to do:

- Draw Sequence diagram of the given scenario

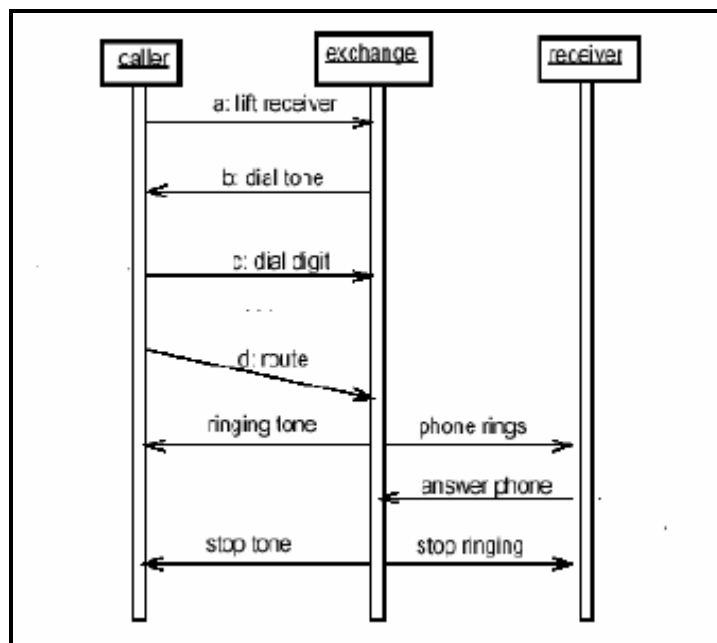
Possible Solution:

Guards in Sequence Diagram

Till now we have discussed the basics of sequence diagram in which communication between objects is condition less but in real-time when modeling object interactions, there will be times when a condition must be met for a message to be sent to the object. There will be certain pre-requisite for communication or a message to be sent to the sender. These conditions are attributed as **“Guard”** in sequence diagram, a guard behaves likes **“if statements”** in the sequence diagram. They are used to control the flow of the messages between objects. Guard (bars) and those elements above the message line being guarded and in front of the message name as shown in the sequence diagram below:

The communication between **Register office** and **drama** will take place only when the past dues of a student is clear and there are no pending dues, this process is verified by AccountsReceivable object of ar class. `[PastDueBalance=0]` is a guard (if statement) which is placed above the message line before the call to `addstudent` method of drama class.

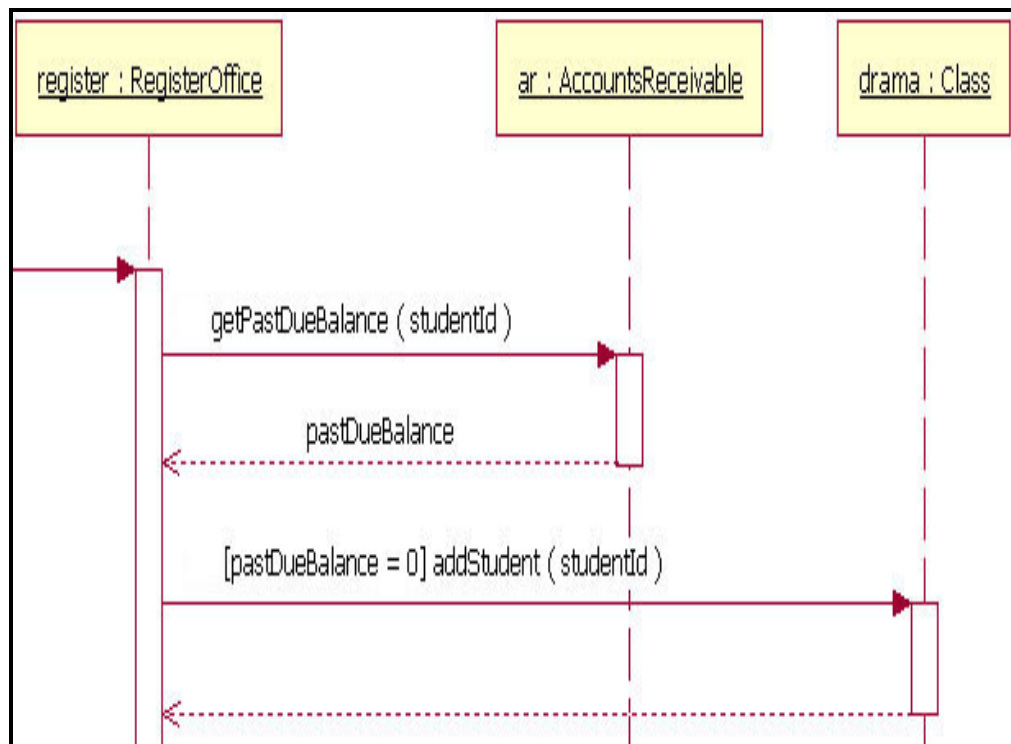

Combined Fragments:

Combined fragment is an interaction fragment which defines a **combination (expression)** of interaction fragments. A combined fragment is defined by an **interaction operator** and corresponding **interaction operands**, for every option there will be corresponding action. In most sequence diagrams, guard is not sufficient to handle the logic required for a sequence being modeled. A combined fragment is used to **group sets of messages** together to show conditional flow in a sequence diagram. We need to show a complete set of sequence of communication flow within sequence diagram. There are three combined fragments which are discussed below:

ALT:

Alt keyword represents alternatives to designate a mutually exclusive choice between two or more message sequences. Alternatives are used to simulate “**if then else**” logic as it occur in the programming languages. Guards are used to simulate Alternatives in Sequence diagram. These guards provide the complete alternate flow within the sequence diagram for communication between objects.

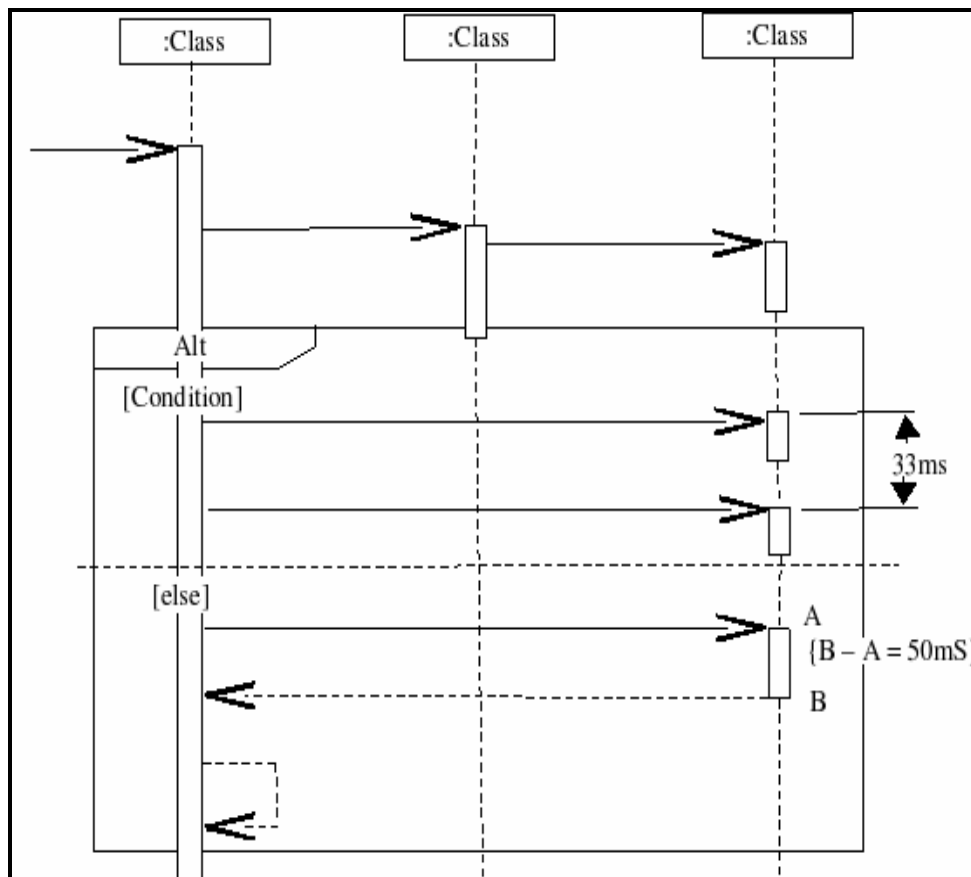

OPT (Options) Guard:

The option guard is used to model a situation that, given a certain condition, will occur; otherwise, the sequence does not occur. An option is used to model a simple “if then” statement. The option combination fragment notation is similar to the alternative combination fragment, except that it only has one operand and there never can be an “else” guard.

To show an option guard, we draw a frame and text “opt” is placed inside the frame's name box and guard is placed at top left corner in the frame's content area. The option's sequence of messages is placed in the remainder of the frame's content area as shown below:

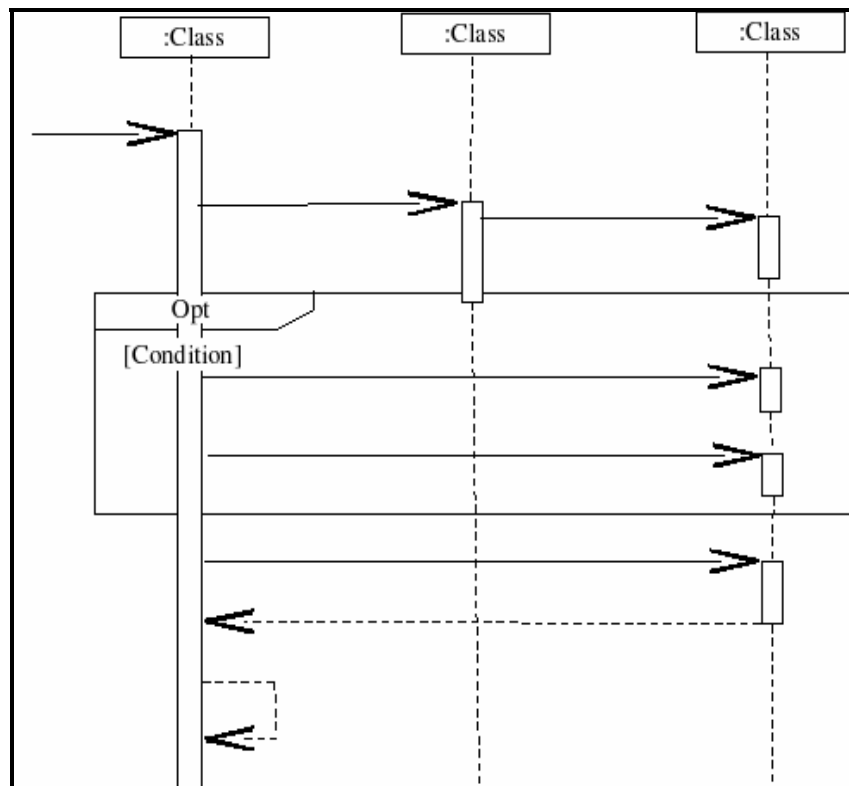

Loop:

Occasionally you may need to model a repetitive sequence. The loop combination fragment is used to model repetitive sequence. The loop combination fragment is similar to the option combination fragment, except that the text **“loop”** is placed in frame's name box. A guard is placed at top left corner inside the frame's content area . Then the loop's sequence of messages is placed in the remainder of the frame's content area as shown below:

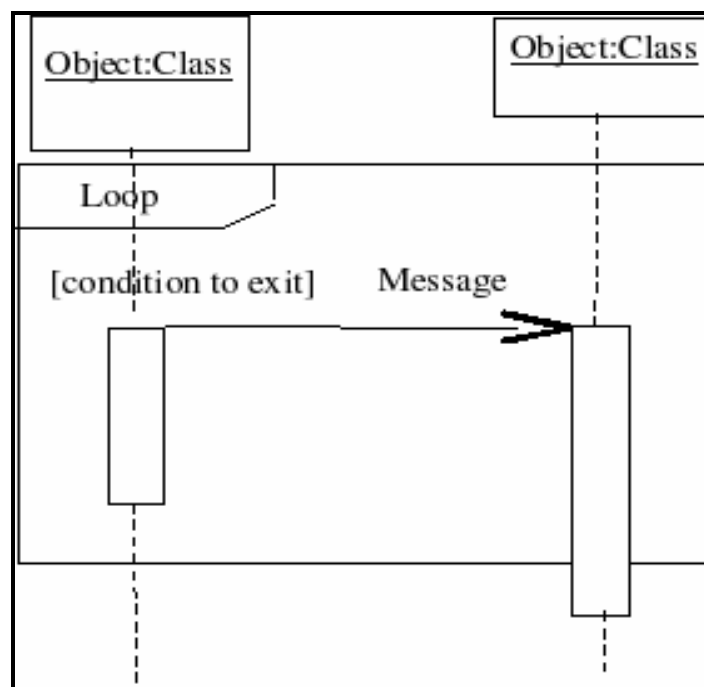

Scenario:

The scenario begins when the owner has placed a answering machine to record the incoming caller messages while the owner is not at home, owner can requests review of messages and ends at the completion of that review. The activities involve are:

1. The owner requests to review new caller messages.
2. The system locates the oldest new caller message.
3. The system displays the caller message on console.
4. The system prompts the owner for for actions to take on the caller message. The owner can leave the message in the system or delete the message.
5. The system locates the next caller message and continues the above cycle until there are no more messages or the owner stops the review.
6. The system updates the message indicator, telling the owner whether there are any more messages to be reviewed.
7. Alternatively, the owner can review all messages without concern about their reviewed state.

The actors and objects involved in these activities are:

- i. Owner
- ii. Console
- iii. AnsweringMachine
- iv. MessageBox
- v. CallerMessage

Possible Solution

The alternate fragment in figure below indicates that the first fragment is executed when the owner selects to review new messages, while other fragment executes when the owner selects to review all messages. There are two loop fragments in figure, the first loop fragment executes until the owner reviews all new messages or owner stops reviewing the messages. The second loop is part of the second operand of the alternate fragment and this loop executes until all messages are reviewed. This part of the sequence diagram does not show all sequences, like caller may not review all messages or delete message. If sequence diagram shows all details, the readability of the diagram will be lost

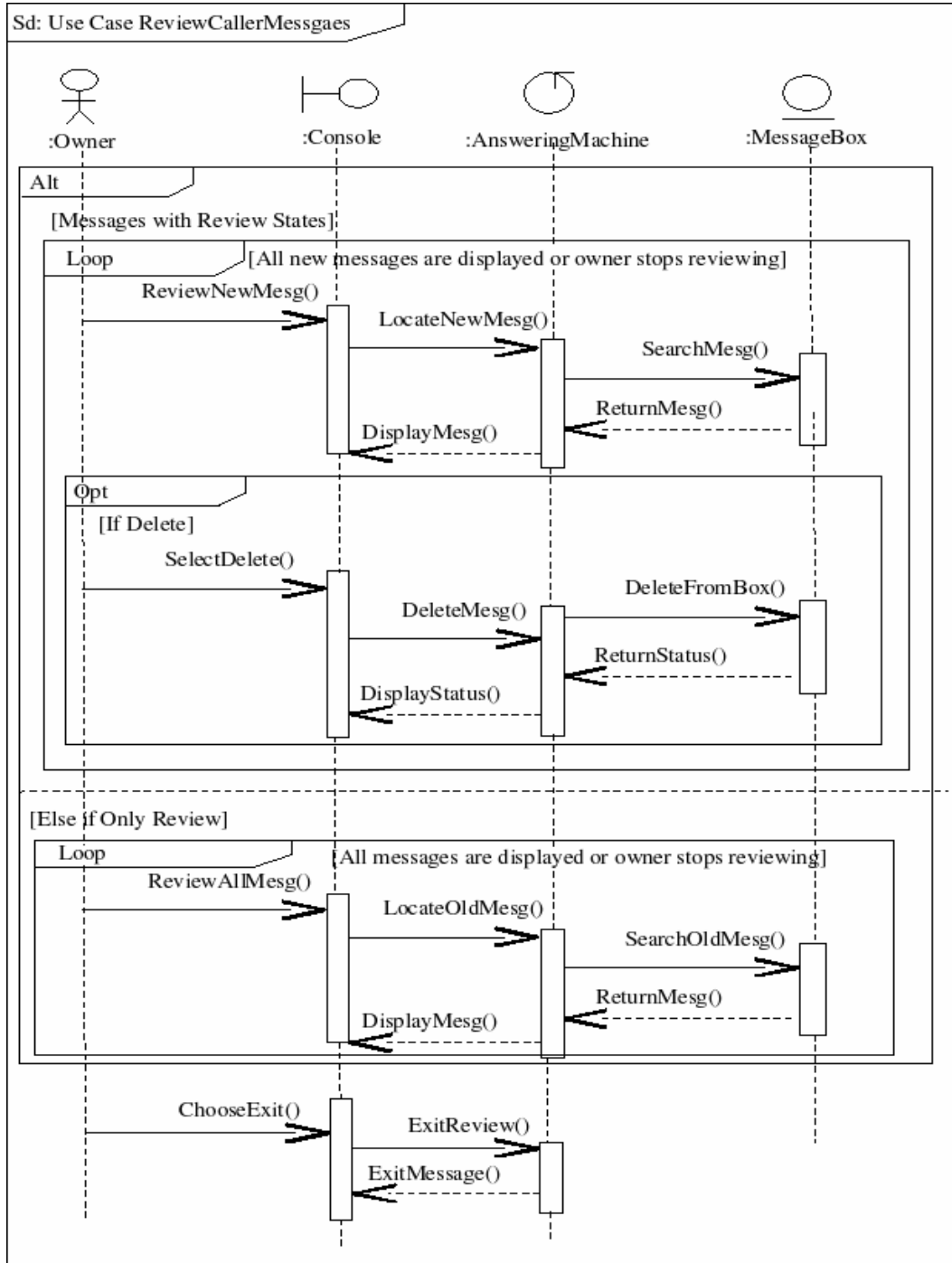

LECTURE NO: 26

Objective:

The objective of this lecture is to have a panel discussion with industry experts on class diagram, the format of this lecture will help us industry perspective on the class diagram, we will give a sample scenario on the spot to the participants (2) and then they will draw class diagram within given time and after that we will have a discussion on the class diagram.

PROBLEM STATEMENT:

A company conceptualizes an idea to develop an online photo album for its potential customer which is using other services provided by the organization. The main intend is to simulate the working of physical photo album and provide its functionality. Each photo album may have more than one photo page, on each photo page there may be either a picture or text. Cover of the photo album will be of fix template like-wise back page of the photo album. Each template will be having locations of place holders, text area etc; each photo page may have a separate template attach to it. Beside template each photo page may have a different background attach to it including color. User will be able to upload their pictures taken from the camera to the free web space provided by the company and then there should be an option of attaching the uploaded pictures any of the place holders also. Beside cover page, there will be an envelope in which album will be wrapped after printing and send back to the client against a particular order which he or she has placed online. You need to keep track of page number for a particular album along with its contents beside the total number of pages which are there in a particular album. At the beginning after cover page there will be a customized message from the CEO for the Customer followed by a blank page, likewise before the back page there will be an empty page attached also as SOP.

Tasks to do:

- The experts are there to define class diagram of the said scenario with potential attributes only, for simplification avoid writing the methods and they are given fix time to solve the problem.

Solution of Participant No 1:

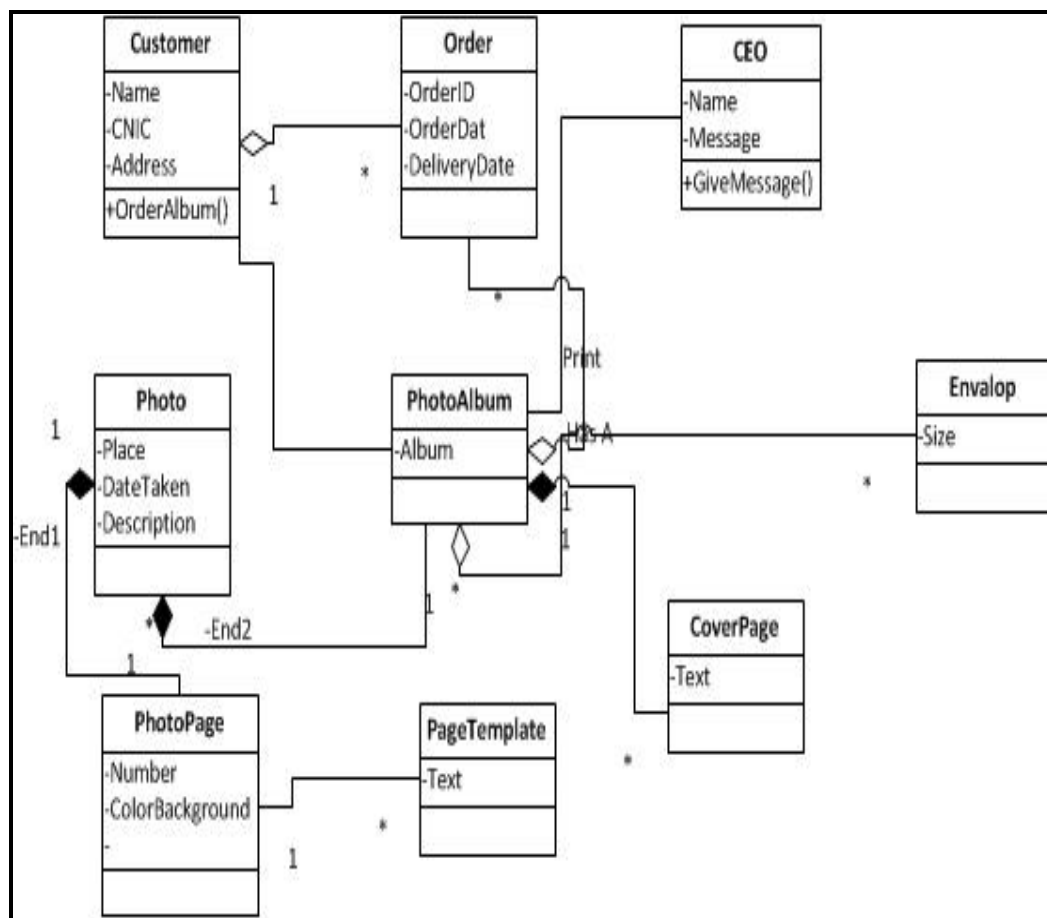

Solution of Participant No 2:

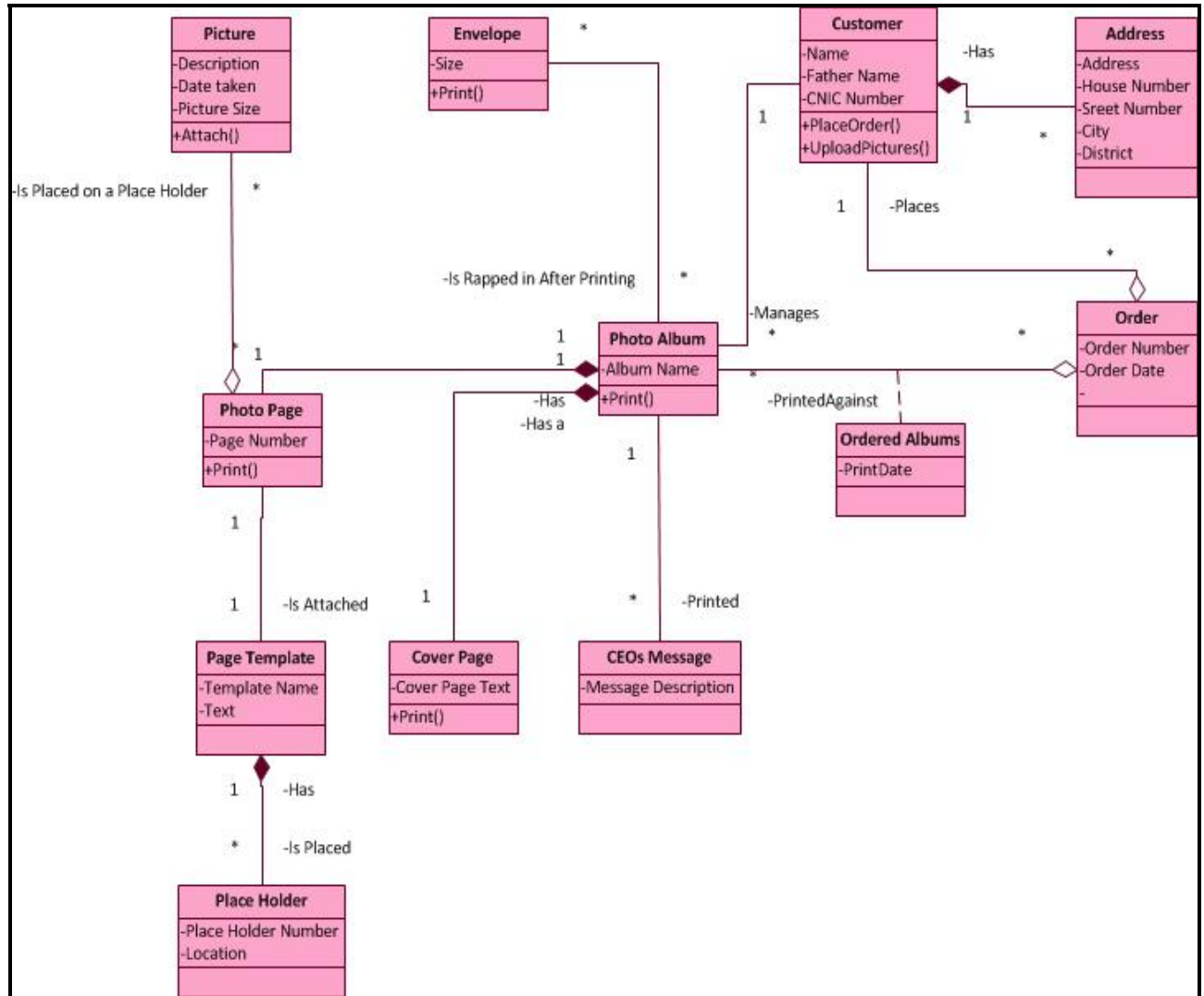

Analysis of the Discussion:

- i. A problem can have different correct versions of solution
- ii. No fix correct solution for a given scenario.
- iii. We might agree to disagree
- iv. A problem can't have more than one **final version** of class diagram

LECTURE NO: 27

Objective:

This lecture will provide a gentle introduction to design patterns along with its history and motivation for it.

Origin and History of Design Pattern

During the late 1970s, an architect named Christopher Alexander carried out the first known work in the area of patterns. In an attempt to identify and describe the wholeness or aliveness of quality designs, Alexander and his colleagues studied different structures that were designed to solve the same problem. He identified similarities among designs that were of high quality. He used the term pattern in the following books to refer to these similarities. During the late 1970s, an architect named Christopher Alexander carried out the first known work in the area of patterns. In an attempt to identify and describe the wholeness or aliveness of quality designs, Alexander and his colleagues studied different structures that were designed to solve the same problem. He identified similarities among designs that were of high quality.

ARCHITECTURAL TO SOFTWARE DESIGN PATTERNS

In 1987, influenced by the writings of Alexander, Kent Beck and Ward Cunningham applied the architectural pattern ideas for the software design and development. They used some of Alexander's ideas to develop a set of patterns for developing elegant user interfaces in Smalltalk. With the results of their work, they gave a presentation entitled Using Pattern Languages for Object-Oriented Programming at the Object-Oriented Programming Systems, Languages, and Applications (OOPSLA) '87 conference. Since then, many papers and presentations relating to patterns have been published by many eminent people in the Object Oriented (OO) world.

In 1994, the publication of the book entitled Design Patterns: Elements of Reusable Object-Oriented Software on design patterns by Erich Gamma, Richard Helm, Ralph Johnson and John Vlissides explained the usefulness of patterns and resulted in the widespread popularity for design patterns. These four authors together are referred to as the Gang of Four (GoF). In this book the authors documented the 23 patterns they found in their work of nearly four and a half years.

Since then, many other books have been published capturing design patterns and other best practices for software engineering.

WHAT IS A DESIGN PATTERN?

A design pattern is a documented best practice or core of a solution that has been applied successfully in multiple environments to solve a problem that recurs in a specific set of situations.

Architect **Christopher Alexander** describes a pattern as “**a recurring solution to a common problem in a given context and system of forces.**” In his definition, the term *context* refers to the set of conditions/situations in which a given pattern is applicable and the term *system of forces* refers to the set of constraints that occur in the specific context.

1. A design pattern is an effective means to convey/communicate what has been learned about high-quality designs. The result is:

- A shared language for communicating the experience gained in dealing with these recurring problems and their solutions.
- A common vocabulary of system design elements for problem solving discussions. A means of reusing and building upon the acquired insight resulting in an improvement in the software quality in terms of its maintainability and reusability.
- A design pattern is not an invention. A design pattern is rather a documented expression of the best way of solving a problem that is observed or discovered during the study or construction of numerous software systems.

2. One of the common misconceptions about design patterns is that they are applied only in an object-oriented environment. Even though design patterns discussions typically refer to the object-oriented development, they are applicable in other areas as well. With only minor changes, a design pattern description can be adjusted to refer to software design patterns.

3. Design patterns are not theoretical constructs. A design pattern can be seen as an encapsulation of a reusable solution that has been applied successfully to solve a common design problem.

Although design patterns refer to the best known ways of solving problems, not all best practices in problem resolution are considered as patterns. A best practice must satisfy the Rule of Three to be treated as a design pattern.

The **Rule of Three:**

“Given solution must be verified to be a recurring phenomenon, preferably in at least three existing systems. Otherwise, the solution is not considered as a pattern”

The goal is to ensure that some community of software professionals applied the solution described by the pattern to solve software design problems.

Elements of Design Patterns:

In general a pattern has four essential elements as below:

1. The pattern name is a handle we can use to describe a design problem, its solution and consequences in a word or two. Naming a pattern immediately increase our design vocabulary. Its lets us design at a higher level of abstraction. Having a vocabulary for patterns let us talk about them with our colleagues, in our documentation and even to ourselves. It makes it easier to think about designs and to communicate them and their trades offs to other. Finding good names has been one of the hardest parts of developing our catalog.

2. The problem describes when to apply the pattern. It explains the problem and its context. It might describe specific design problem such as how to represent algorithms as object. It might describe class or object structure that is indicative of an inflexible design. Sometimes the problem will include a list of conditions that must be met before it makes sense to apply the pattern.

3. The solution describes the elements that make up the design, their relationships, responsibilities and collaborations. The solution doesn't describe a particular concrete design or implementation, because a pattern is like a template that can be applied in many different situations. Instead, the pattern provides an abstract description of a design problems and how a general arrangement of elements (classes and objects in our case) solve it.

4. The consequences are the results and tradeoffs of applying the pattern. Though consequences are often unvoiced when we describe design decisions, they are critical for evaluating design alternatives and for understanding the costs and benefits of applying the pattern. The consequences for software often concern space and time tradeoffs. They may address language and implementation issues as well. Since reuse is often a factor in object oriented design, the consequences of a pattern include its impact on a system flexibility, extensibility or portability. Listing these consequences explicitly helps you understand and evaluate them

Here we just present the comparison of Design and Framework because seemingly by nature both concepts seem to be true but here you can see their comparison:

<i>Design Patterns</i>	<i>Frameworks</i>
Design patterns are recurring solutions to problems that arise during the life of a software application in a particular context.	A framework is a group of components that cooperate with each other to provide a reusable architecture for applications with a given domain.
The primary goal is to:	The primary goal is to:
<ul style="list-style-type: none"> • Help improve the quality of the software in terms of the software being reusable, maintainable, extensible, etc. • Reduce the development time 	<ul style="list-style-type: none"> • Help improve the quality of the software in terms of the software being reusable, maintainable, extensible, etc. • Reduce development time
Patterns are logical in nature.	Frameworks are more physical in nature, as they exist in the form of some software.
Pattern descriptions are usually independent of programming language or implementation details.	Because frameworks exist in the form of some software, they are implementation-specific.
Patterns are more generic in nature and can be used in almost any kind of application.	Frameworks provide domain-specific functionality.
A design pattern does not exist in the form of a software component on its own. It needs to be implemented explicitly each time it is used.	Frameworks are not complete applications on their own. Complete applications can be built by either inheriting the components const directly.
Patterns provide a way to do “good” design and are used to help design frameworks.	Design patterns may be used in the design and implementation of a framework. In other words, frameworks typically embody several design patterns.

LECTURE NO: 28 & 29

Objective:

This chapter will cover 2 lectures; it will provide an introduction to categories of software design patterns and will have in depth discussion on first design pattern of creational category i-e Factory design pattern. Factory design pattern will be discussed in detail with relevant diagrams and concepts followed by example and code in Java

Categories of Software Design Pattern:

Design patterns vary in their granularity and level of abstraction, because there are many design patterns, we need a way to organize them. Software Design pattern are mainly divided into three categories:

- i. **Creational**
- ii. **Structural**
- iii. **Behavioral**

Each category have its related multiple design pattern but we will be discussing some of the important pattern of each category. The objective is to provide of in-depth knowledge of each category with discussion on specific design patterns, as discussed above the total number of design patterns are countless because they are scenario specific and we can't limit the scenario or situation to change as **“Change is the only constant”** in software development.

i. **Creational Patterns:**

Creational design patterns abstract the instantiation process or in other words we can say that it make the underlying system independent of how the objects are created, composed and represented. These patterns become more important as systems evolve to depend more on objects composition than inheritance from it we can infer that hard-coding of object will be more difficult

to handle so we can rightly say that focus will toward defining the basis or common behaviors in such a way that these common behavior can be composed to form complex ones.

It then suggest that creational design patterns provides a lot of flexibility in what gets created, who creates it and how it get created and when. All the system at large knows about the objects is their interfaces as defined by abstract classes and user can configure a system with “**Product**” objects that vary widely in structure and functionality. At times patterns of this category are competitors and either can be used profitably and at times they are complementary.

Factory Pattern

Intent

To define an interface for creating an object but let subclass decides which class to instantiate as per request of the client.

Motivation

At times there exist class hierarchies i-e super / sub classes then client object usually know which class /sub class to instantiate but at times client object know that it needs t instantiate the object but of which class it does not know ; it may be due to many factors

- The state of the running application
- Application configuration settings
- Expansion of requirements or enhancements

In such cases, an application object needs to implement the class selection criteria to instantiate an appropriate class from the hierarchy to access its services and that selection criteria will be considered as a part of the client code to access the concrete class from hierarchies of classes. This has inherited problem **of high degree of coupling** between client and classes in hierarchies and as the criteria changes there should be a mechanism which should notify all the client objects to incorporate that changed criteria as shown below:

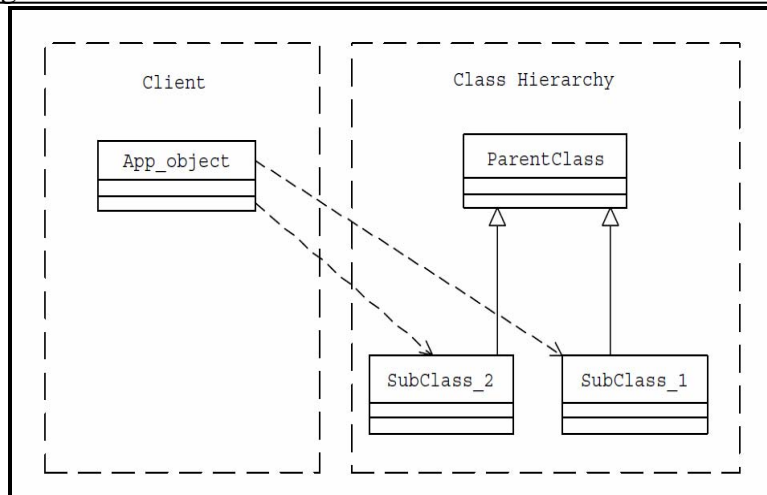

Proposed Solution:

The solution given above has the build violation of principle of software design i-e **“Loose coupling”**; as opposite to the principle above solution is having high degree of coupling between client and classes in hierarchies. The solution we present here is based on the rule of **“Decoupling the client from object creation”**. There should be a separate class which should take care of object creation of appropriate class from hierarchy of classes as per request from the client hence we suggest encapsulating the functionality to instantiate and creating the required object separately from the client class. The separate class will return the instance of required class as per request of client.

Factory Pattern Defined

“Factory Pattern defines an interface for creating the object but let the subclass decide which class to instantiate. Factory pattern let the class defer instantiation to the sub class”

Class Diagram

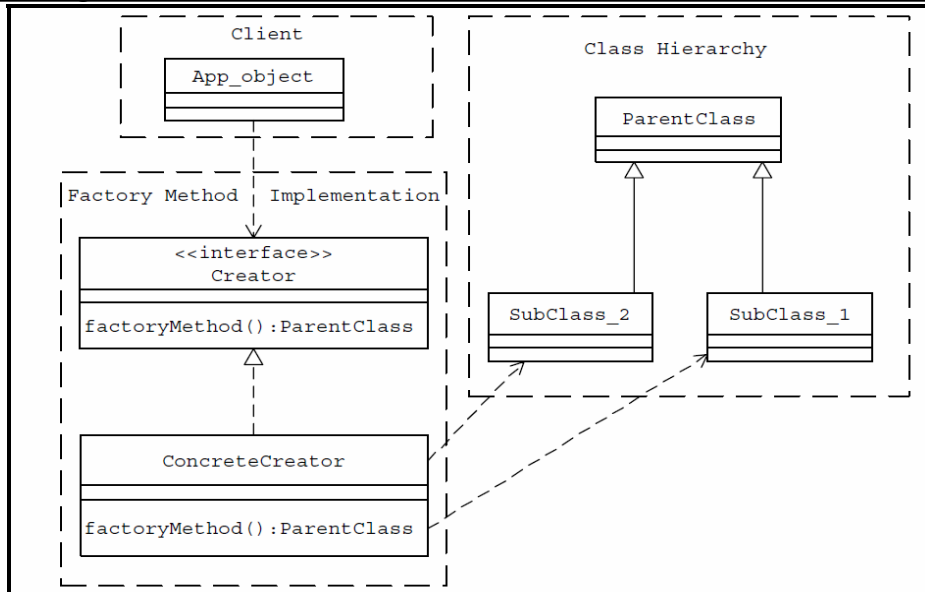

As shown in the class diagram above, there is a interface (Creator) which is exposed to the client, concrete implementation of this interface (concrete creator) is solely responsible for instantiation details and object creation of the relevant class from class hierarchy. Application objects can make use of the factory method defined in creator and implemented in concrete creator class; to get access to the appropriate class instance. This eliminates the need for an application object to deal with the varying class selection criteria. Besides the class selection criteria, the factory method also implements any special mechanisms required to instantiate the selected class. This is applicable if different classes in the hierarchy need to be instantiated in different ways. The factory method hides these details from application objects and eliminates the need for them to deal with these details.

Applicability:

Factory method can be applied when:

- i. A class can't anticipate the class of object it must create.
- ii. A class wants its subclass to specify the objects it creates.
- iii. A class delegates the responsibility to one of its sub class for localization of object instantiation.

Problem Statement:

We want the user to enter the name in either “first name last name or last name, first name” format. We have made the assumption that there will always be a comma between last name and first name and space between first name last names. The client does not need to be worried about which class is to access when it is entering the name in either of the format. Independent of the format of the data to be entered, system will display first name and last name.

Justification for Application of Factory Pattern:

In the scenario given above the client have multiple options to enter the data in term of format but the logic to display first name and last name is derived from the format in which data is entered. So there will be multiple options (classes) out of which related class will be selected (instance) and returned to display the first name and last name.

Proposed Class Diagram

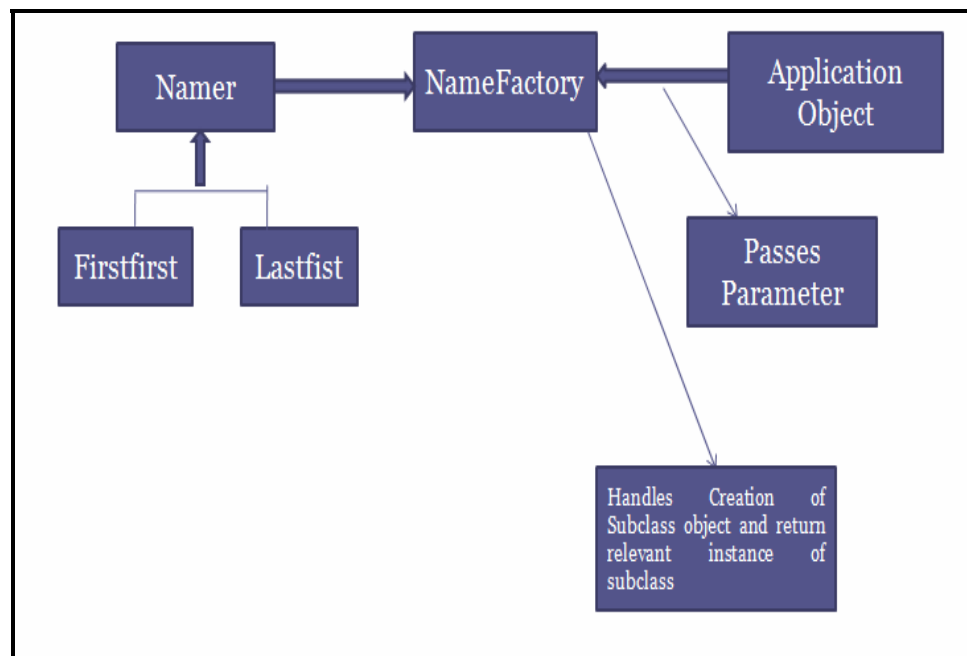

Java Code:**i. Class Namer:**

```
class Namer
{
protected String last; //store last name here
protected String first; //store first name here
public String getFirst()
{
return first; //return first name
}
public String getLast() {
return last; //return last name
}}
```

ii. Class Firstfirst

```
class Firstfirst extends Namer
{ //split first last
public FirstFirst(String s)
{
int i = s.lastIndexOf(" "); //find sep space
if (i > 0)
{
//left is first name
first = s.substring(0, i).trim();
//right is last name
last =s.substring(i+1).trim();
}
else
{
first = ""; // put all in last name
last = s; // if no space
}}}
```

iii. Class Last First

```
class LastFirst extends Namer

{ //split last, first

public LastFirst(String s)

{

int i = s.indexOf(","); //find comma

if (i > 0)

{

//left is last name

last = s.substring(0, i).trim();

//right is first name

first = s.substring(i + 1).trim();

}

else {

last = s; // put all in last name

first = ""; // if no comma

}}}

}
```

iv. Factory i-e NameFactory

```
class NameFactory
{
//returns an instance of LastFirst or FirstFirst
//depending on whether a comma is found
public Namer getNamer(String entry)
{
int i = entry.indexOf(","); //comma determines name order
if (i>0)
return new LastFirst(entry); //return one class
else
return new FirstFirst(entry); //or the other
}
}
```

v. Testing the Factory – Application Object

```
public class testFactory
{
public static void main(String args[])
{
NameFactory nfactory = new NameFactory();
String name="Ali khan";
Namer namer = nfactory.getNamer(name); - Delegation
//compute the first and last names
//using the returned class
System.out.println(namer.getFirst());
System.out.println(namer.getLast());
}}
```

Consequences of Factory Pattern:

- Factory pattern will intrinsically eliminate the need to bind application-specific classes into your code. The code only deal with the interface exposed to it.

- The potential disadvantage of using factory pattern is that client might have to subclass the creator class just to create a particular concrete class. Subclassing is fine when the client has to subclass the creator class any way but otherwise the client must deal with another point of evolution.

LECTURE NO: 30 && 31

Objective:

In these 2 lectures we will discuss singleton design pattern of the creational category of design pattern in detail with example.

Intent:

Ensure a class has one instance, and provide a global point of access to it.

Motivation:

It is important for some classes to have exactly one instance. Although there can be many printers but there should be only one printer spooler. There should be only one file system and one window manager. For practical systems, an accounting system contains accounts details for any particular one company. These reasoning's does not make the case or provide sufficient knowledge that how to ensure that a class has only one instance but that instance is easily accessible globally.

Possible Solution:

As a programming freak one might come up with idea of using global variable to provide global access and that's appeal at first glance but when we look solution in detail it provide solution to part of problem not the complete problem, our problem consists of two components that a class should have only one instance and it should be globally accessible, the solution solve the later part but provide no solution to first part of problem. Global variable makes an object accessible but it doesn't prevent client from instantiating multiple objects.

For this approach to be successful all of the client objects have to be responsible for controlling the number of instances of the class but that's not a good idea because we never recommend coupling between business logic with client code and client should be free from process of object creation and management.

Refined Solution:

A better solution would be to make the class itself responsible for keeping track of its sole instance. Only class itself can ensure that no other instance is created and it can provide a way to access the instance. This is what is known as “**Singleton Pattern**”.

Singleton Pattern Defined:

“Singleton Design Pattern ensures that there is only one instance of a class and provides global point of access to it”

Class Diagram

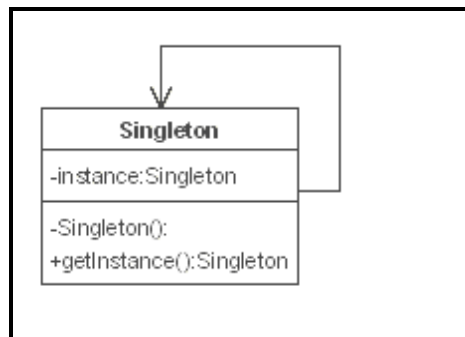

Note: This is another version of class diagram as discussed in the lectures but the essence and motivation is same.

Implementation of Class Diagram

The implementation involves a static member in the "Singleton" class, a private constructor and a **static public method** i.e `getInstance ()`; that returns a reference to the static member. Static method don't need an object to be accessed it can be accessed by mentioning class name directly and it maintain only one value across all the instances of that class.

Java Code

```
public class Singleton
{
    private static Singleton instance;

    private Singleton() // Private Constructor
    {}

    public static synchronized Singleton getInstance()
    {
        if (instance == null)
            instance = new Singleton();

        return instance;
    }
}
```

We can notice in the above code that `getInstance` method ensures that only one instance of the class is created. The constructor should not be accessible from the outside of the class to ensure the only way of instantiating the class would be only through the `getInstance` method. An above singleton implementation should work in any conditions in the multi-threaded environment. This is why we need to ensure it works when multiple threads are used to make sure the reads/writes are synchronized. This multi-thread safe implementation is achieved through `synchronized` keyword used before Singleton of `getInstance ()` method.

The `getInstance` method is used also to provide a global point of access to the object and it can be used in the following manner:

```
Singleton.getInstance().test(); //test=Any method
```

`test()` is any method which is defined in the singleton class to implement the business logic.

Problem with Above Solution:

The above solution solves our problem of multi-threading but synchronization decreases performance by factor of 100!!!, this solution fixes our problem but it is very expensive. Indeed we only need synchronization for the first call. After that synchronization is totally unneeded. So we need an optimized version of our solution in which we should avoid unnecessary object instantiation or we can say instance management should be an efficient one rather than a robust one.

Lazy instantiation using double locking mechanism

The standard implementation shown in the above code is a thread safe implementation, but it's not the best thread-safe implementation because synchronization is very expensive when we are talking about the performance. We can see that the **synchronized** method `getInstance` does not need to be checked for synchronization after the object is initialized. If we see that the singleton object is already created we just have to return it without using any synchronized block. This optimization consists in checking in an unsynchronized block if the object is null and if not to check again and create it in a synchronized block. This is called **double locking mechanism**.

In this case the singleton instance is created when the `getInstance ()` method is called for the first time. This is called **lazy instantiation** and it ensures that the singleton instance is created only when it is needed.

Java Code using Double Checking Mechanism

```
class Singleton
{
    private static Singleton instance;

    private Singleton()
    {
        System.out.println("Singleton(): Initializing Instance");
    }

    public static Singleton getInstance()
    {
        if (instance == null)
        {
            synchronized(Singleton.class)
            {
                if (instance == null)
                {
                    System.out.println("getInstance(): First time getInstance was invoked!");
                    instance = new Singleton();
                }
            }
        }

        return instance;
    }

    public void doSomething()
    {
        System.out.println("doSomething(): Singleton does something!");
    }
}
```

Applicability:

We can use the singleton design pattern when:

- i. There must be exactly one instance of a class, and it must be accessible to clients from a well-known access points.
- ii. When the sole instance should be extensible by sub classing and clients should be able to use an extended instance without modifying the underlying code

Example of Applying Singleton Design Pattern

Scenario:

In Chocolate manufacturing industry, there are computer controlled chocolate boilers. The job of boiler is to take in milk and chocolate, bring them to boil and then pass it on to the next phase of chocolate manufacturing process. We have to make sure that bad things don't happen like filling the filled boiler or boiling empty boiler or draining out unboiled mixture. We have to make sure that there should be no simultaneous boiler activity taking place.

Justification for applying Singleton Design Pattern

Possible Solution

Java Code:

```
public class ChocolateBoiler {  
  
    private boolean empty;  
  
    private boolean boiled;  
  
    private static ChocolateBoiler uniqueins;  
  
    private ChocolateBoiler()  
  
    {  
  
        empty=true;  
  
        boiled=false;  
  
    }  
}
```

```
public static ChocolateBoiler getInstance()
{
    if(uniqueins==null)
    {
        new ChocolateBoiler();
    }
    public static ChocolateBoiler getInstance()
    {
        if(uniqueins==null)
        {
            uniqueins=new ChocolateBoiler();
            getInstance().fill();
            getInstance().boil();
            getInstance().drain();
        }
        return uniqueins;
    }
}
```

```
public void fill()
{
if(isempty())
{
empty=false;
empty=true;
}}
public void drain()
{
if(!isempty() && isboiled())
{
empty=true;
}}

public void boil()
{
if(!isempty() && !isboiled())
{
boiled=true;
}}
public boolean isempty()
{
return empty;
}
public boolean isboiled()
{
return boiled;
}}
```

Problem with Existing Code:

In the above code there is a possibility that while batch of milk and chocolate is boiling, filling method starts to fill the boiler. While one object is calling the boiling method other object has called the fill method. This is possible due to simultaneous access of object which leads us to starting of a new process without finishing the previous one which is a pre-requisite for the next one.

Possible Solution

The problem lies with simultaneous threads executing at the same time and this can happen and this is what has happen. We need to make our code Thread safe i-e we need to add code to handle multithreading.

Improved Version of Java Code

```
public static synchronized ChocolateBoiler getInstance()
{
    if(uniqueins==null)
    {
        uniqueins=new ChocolateBoiler();
        getInstance().fill();
        getInstance().boil();
        getInstance().drain();
    }
    return uniqueins;
}
```

To Do Task:

Assuming Database is not providing Referential Integrity Constraints support i-e Primary key, foreign key and Unique key, your task is to design a database engine with your own built in Referential integrity rules implementation and you need that only one database connection is maintained which an application should access to perform business logic. Apply any scenario to test your database engine.

LECTURE NO: 32

Objective:

In this lecture we will discuss prototype design pattern of the creational category of design pattern in detail with example.

Prototype Design Pattern:

Today's programming is all about costs in term of time and resources. Saving is a big issue when it comes to using computer resources, so programmers are doing their best to find ways of improving the performance of the program, process of object creation is very critical to improving the performance of any program. As discussed in earlier lectures, Factory pattern allow a system to be independent of the object creation process. In other words, these patterns enable a client object to create an instance of an appropriate class by invoking a designated method without having to specify the exact concrete class to be instantiated. While addressing the same problem as the Factory Method, the Prototype pattern offers a different but an optimized version when a client needs to create a set of objects that are alike or differ from each other only in terms of their state and it is expensive to create such objects in terms of the time and the processing involved.

Intent

To reuse already instantiated objects that has already performed time-consuming instantiation process.

Object Cloning:

Cloning is a process in which one object is created upfront and designate it as a prototype object, other objects are created by simply making a copy of the prototype object and making required modifications.

Cloning in Java

In Java, objects are manipulated through reference variables, and there is no operator for copying an object—the assignment operator duplicates the reference, not the object.

clone() is a method in the Java programming language for object duplication and clone method available in base class i-e Object class. The return type of clone method is Object, and needs to be explicitly cast back into the appropriate type.

Types of Object Cloning:

An object can be cloned by using copy process; there are two ways to copy data from one object to another:

- i. **Shallow Copy**
- ii. **Deep Copy**

i. Cloned as Shallow Copy

In type of copy the original top-level object and all of its primitive members are duplicated. Any lower-level objects that the top-level object contains are not duplicated. Only references to these objects are copied. This means that if an object is containing inside it then only parent object will be copied while we clone the object (parent) but the contained object will not be copied in the cloned object. This results in both the original and the cloned object referring to the same copy of the lower-level object and there will be total of 3 objects as shown below:

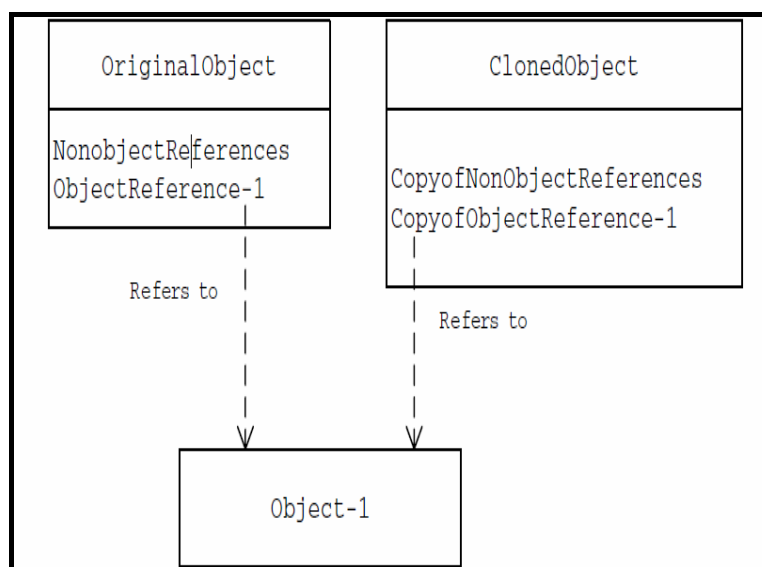

ii. Cloned as Deep Copy

In type of copy the original top-level object and all of its primitive members and any lower-level objects that the top-level object contains are also duplicated. This means that if an object is containing inside it then only parent object will be copied while we clone the object (parent) the contents of contained object will also be copied in the cloned object. In this case, both the original and the cloned object refer to two different lower-level objects i.e there will be total of 4 objects as compared to three objects in shallow copy. This is shown in the diagram below:

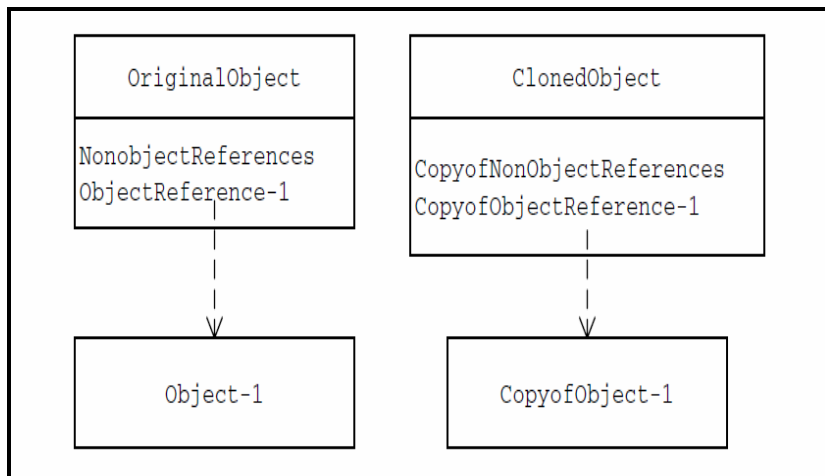

Class Diagram:

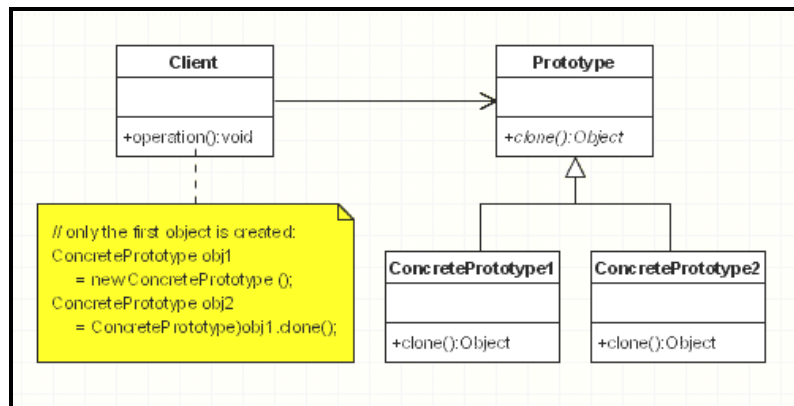

The process of cloning starts with an initialized and instantiated class. The Client asks for a new object of that type and sends the request to the Prototype class. A ConcretePrototype, depending

on the type of object is needed, will handle the cloning through the Clone () method, making a new instance of itself.

Java Code of the above class diagram

```
public interface Prototype {  
    public abstract Object clone ();  
}  
  
public class ConcretePrototype implements Prototype {  
    public Object clone() {  
        return super.clone();  
    }  
}  
  
public class Client {  
  
    public static void main( String arg[] )  
    {  
        ConcretePrototype obj1= new ConcretePrototype ();  
        ConcretePrototype obj2 = ConcretePrototype)obj1.clone();  
    }  
  
}
```

Applicability:

We can use the prototype pattern when a system should be independent of how the products are created, composed and represented; and

- i. When the classes to instantiate are specified at run-time for example by using dynamic loading.
- ii. When heavy weight objects are required at number of occasions during the application.

Example

A computer user in a typical organization is associated with a user account. A user account can be part of one or more groups. Permissions on different resources (such as servers, printers, etc.) are defined at the group level. A user gets all the permissions defined for all groups that his or her account is part of. Let us build an application to facilitate the creation of user accounts.

- For simplicity, let us consider only two groups — Supervisor and AccountRep — representing users who are supervisors and account representatives, respectively and we have defined permissions in text files for each user group.

Proposed User Account Class:

UserAccount
<pre> userName: String password: String fname: String lname: String permissions: Vector </pre>
<pre> setUserName (userName: String) setPassword (pwd: String) setFName (fname: String) setLName (lname: String) setPermission (rights: Vector) getUserName () : String getPassword () : String getFName () : String getLName () : String </pre>

Steps in Execution of Application:

- i. Instantiate the UserAccount class
- ii. Read permissions from an appropriate data file
- iii. Set these permissions in the UserAccount object.

The above mention process looks straightforward, it is not efficient as it involves expensive file I/O (input/output) each time an account is created. We need to optimize this to reduce the number of I/O so that heavy weight object is not created for every account. **This provide us justification for using “Prototype Design Pattern”**

Optimized Solution:

- i. Re-Designing the UserAccount class to implement the Cloneable interface
- ii. Returning a shallow copy of itself as part of its implementation of the clone method

Java Code of User Class using Cloneable Interface:

```
public class UserAccount implements Cloneable {  
    private String userName;  
    private String password;  
    private String fname;  
    private String lname;  
    private Vector permissions = new Vector();  
  
    public Object clone() {  
        //Shallow Copy  
        try {  
            return super.clone();  
        } catch (CloneNotSupportedException e) {
```

```
return null;}
```

Optimized Class Diagram:

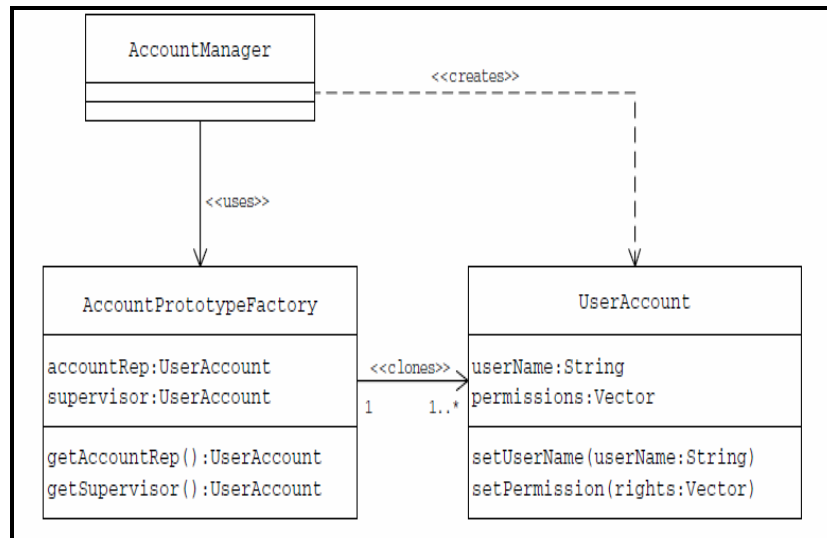

Java Code for Optimized Class Diagram:

i. AccountPrototypeFactory Class

```

public class AccountPrototypeFactory {
    private UserAccount accountRep;
    private UserAccount supervisor;
    public AccountPrototypeFactory(UserAccount supervisorAccount, UserAccount arep)
    {
        accountRep = arep;
        supervisor = supervisorAccount;
    }
    public UserAccount getAccountRep() {
        return (UserAccount) accountRep.clone();
    }
}
  
```

```
public UserAccount getSupervisor() {  
  
return (UserAccount) supervisor.clone();  
  
}}
```

AccountManager Class:

```
public class AccountManager {  
public static void main(String[] args) {  
/*  
Create Prototypical Objects  
*/  
Vector supervisorPermissions = getPermissionsFromFile("supervisor.txt");  
UserAccount supervisor = new UserAccount();  
supervisor.setPermissions(supervisorPermissions);  
Vector accountRepPermissions = getPermissionsFromFile("accountrep.txt");  
UserAccount accountRep = new UserAccount();  
accountRep.setPermissions(accountRepPermissions);  
AccountPrototypeFactory factory = new AccountPrototypeFactory(supervisor, AccountRep);  
  
/* Using prototype objects to create clones of user accounts */  
  
UserAccount newSupervisor = factory.getSupervisor(); - Cloning is performed using existing  
factory object  
newSupervisor.setUserName("Ali");  
newSupervisor.setPassword("canvas");  
System.out.println(newSupervisor);  
UserAccount anotherSupervisor = factory.getSupervisor();  
anotherSupervisor.setUserName("Asim");  
anotherSupervisor.setPassword("temp");  
System.out.println(anotherSupervisor);  
UserAccount newAccountRep = factory.getAccountRep();  
newAccountRep.setUserName("Ahmad");  
newAccountRep.setPassword("Pakistan");  
System.out.println(newAccountRep);  
}
```

LECTURE NO: 33

Objective:

In this lecture we will discuss last design pattern of creational category, this design pattern is builder design pattern. We will discuss this design pattern in detail with example.

Motivation:

In broad spectrum object construction phase i-e details about components that make up an object are kept within the object, often as part of its constructor and this is usual design and programming practice. This type of design closely ties the object construction process with the components that make up the object. This approach is well suited for the objects whose details are simple but with the increase in complexity and number of components this approach is not suited merely due to maintenance issues. This approach is suitable as long as the object under construction is simple and the object construction process is definite and always produces the same representation of the object. This design may not be effective when the object being created is complex and the series of steps constituting the object creation process can be implemented in different ways producing different representations of the object. Different implementations of the construction process are all kept within the object, the object can become bulky (construction bloat) and less modular. Subsequently, adding a new implementation or making changes to an existing implementation requires changes to the existing code. Complex objects are made of parts produced by other objects that need special care when being built. An application might need a mechanism for building complex objects that is independent from the ones that make up the object.

Intent of Builder Design Pattern

- i. Defines an instance for creating an object but letting subclasses decide which class to instantiate
- ii. Refers to the newly created object through a common interface.
- iii. Separate the construction of a complex object from its representation so that the same construction process can create different representations.

Builder Design Pattern:

To address the problem as discussed in previous section, the Builder pattern suggests moving the construction logic out of the object class to a separate class referred to as **a builder class**. There can be more than one such builder class each with different implementation for the series of steps to construct the object. Each such builder implementation results in a different representation of the object. This type of separation reduces the object size. The object construction process becomes independent of the components that make up the object. This provides more control over the object construction process. The suggested class diagram based on such a mechanism is shown below:

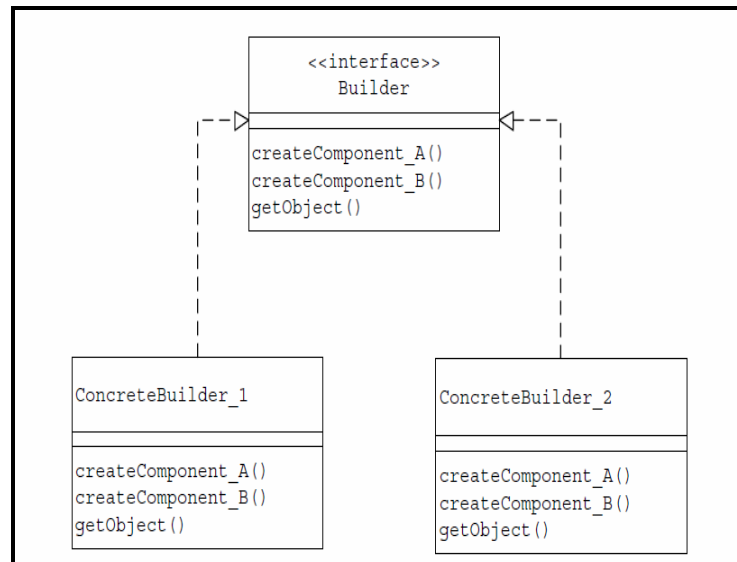

➤ Sequence Diagram of above Application

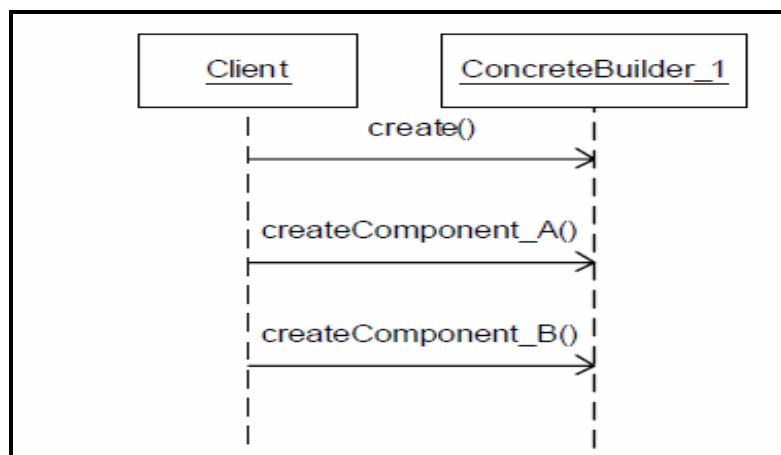

As shown in the sequence diagram, clients are initiating concrete objects which indirectly mean that client should be aware of the object construction phase to create the complex objects. There is tight coupling between client and object construction phase. Whenever the construction logic undergoes a change, all client objects need to be modified accordingly. This implies that we are making clients responsible to manage the object creation process which is certainly not wanted and this is also a violation of design principles of **loose coupling**.

Builder Design Pattern:

We need to solve the problem of tight coupling that exists in the suggested solution between client and object, in solving this problem the Builder pattern suggests using a dedicated object referred to as a **Director**, which is responsible for invoking different builder methods required for the construction of the final object rather than client is required to invoke the concrete objects directly. Different client objects can make use of the Director object to create the required object and once the object is constructed, the client object can directly request from the builder the fully constructed object.

Class Diagram

An improved version or actual class diagram of builder design pattern is as shown below:

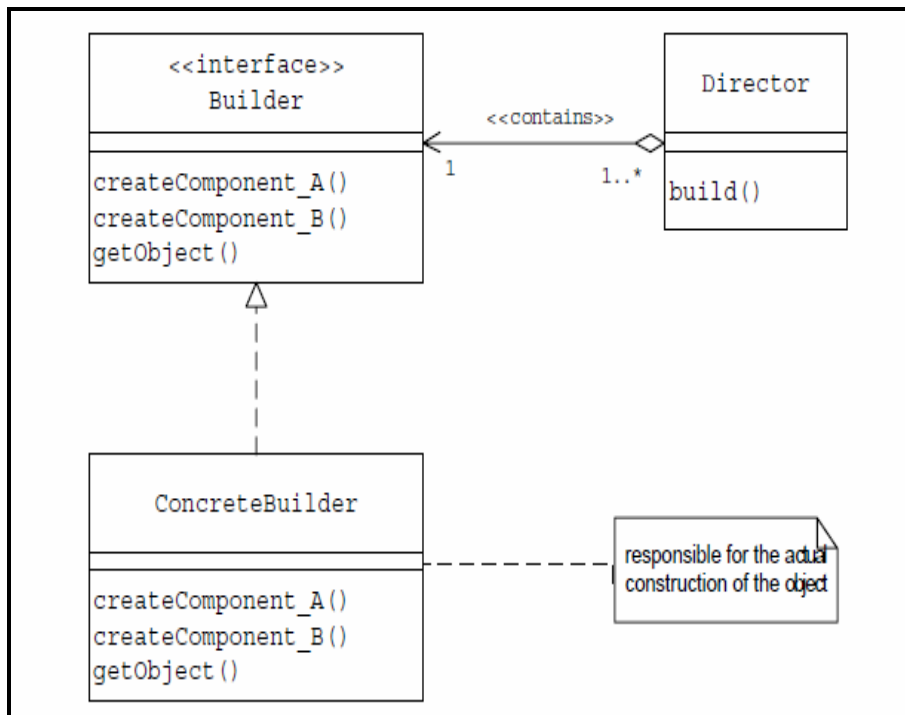

Application Flow:

- i. The client object creates instances of an appropriate concrete Builder implementer and the Director. The client may use a factory for creating an appropriate Builder object.
- ii. The client associates the Builder object with the Director object.
- iii. The client invokes the build method on the Director instance to begin the object creation process. Internally, the Director invokes different Builder methods required to construct the final object.
- iv. Once the object creation is completed, the client invokes the getObject method on the concrete Builder instance to get the newly created object.

Sequence Diagram of Application:

The sequence diagram is as per improved version of class diagram as shown above:

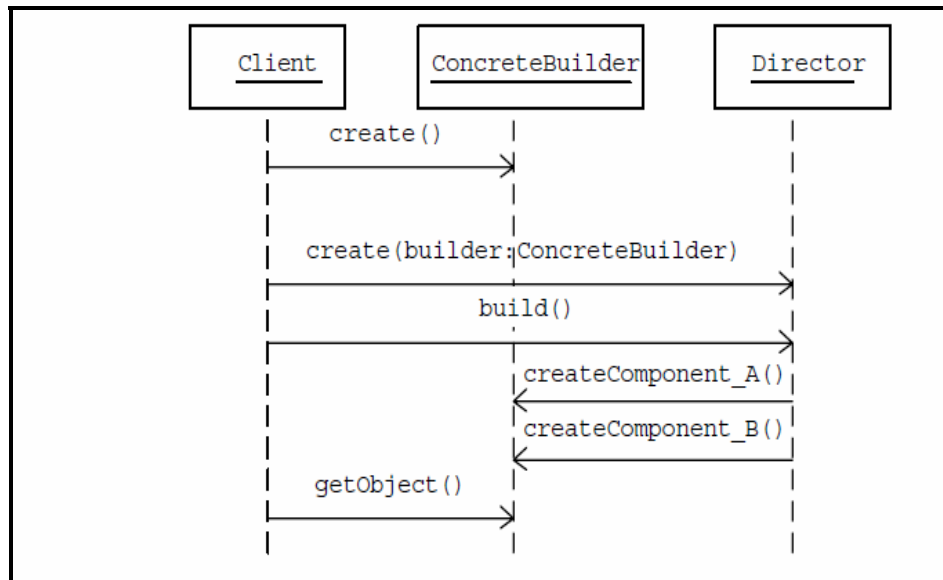

Example:

Consider construction of a home, Home is the final end product (object) that is to be returned as the output of the construction process. It will have many steps, like basement construction, wall construction and so on roof construction. Finally the whole home object is returned. Here using the same process you can build houses with different properties. Each house is having same construction steps but the output may be different depending upon the requirements of the house but the end product is home in any case. We need to write programs which simulate this process.

Suggested Class Diagram:

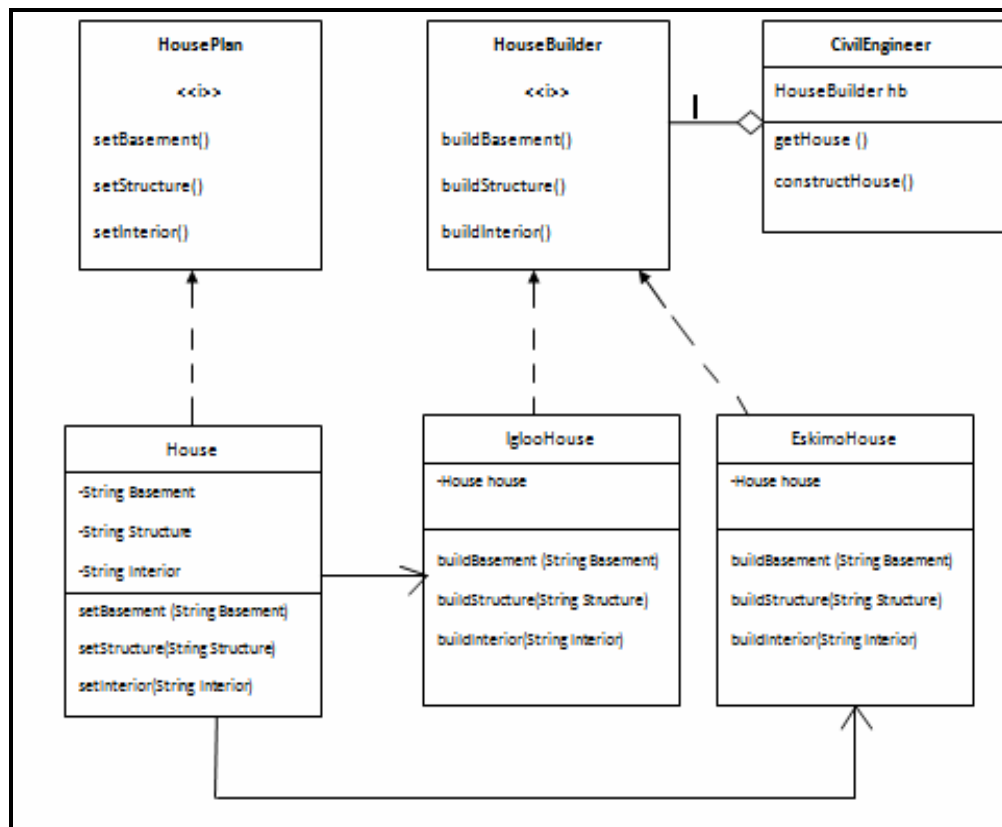

Java Code:**i. House Plan Interface Class:**

```
package BuildingHouse;

public interface HousePlan {

    public void setBasement(String basement);

    public void setStructure(String structure);

    public void setRoof(String roof);

    public void setInterior(String interior);
}
```

ii. House Class:

```
package BuildingHouse;

public class House implements HousePlan {

    private String basement;
    private String structure;
    private String roof;
    private String interior;

    public void setBasement(String basement) {
        this.basement = basement;
    }

    public void setStructure(String structure) {
        this.structure = structure;
    }

    public void setRoof(String roof) {
```

```
        this.roof = roof;
    }

    public void setInterior(String interior) {
        this.interior = interior;
    }
}
```

iii. HouseBuilder Interface Class

```
package BuildingHouse;

public interface HouseBuilder {

    public void buildBasement();

    public void buildStructure();

    public void bulidRoof();

    public void buildInterior();

    public House getHouse();
}
```

iv. CivilEngineer Class

```
package BuildingHouse;

public class CivilEngineer {

    private HouseBuilder houseBuilder;

    public CivilEngineer(HouseBuilder houseBuilder){
        this.houseBuilder = houseBuilder;
    }
}
```

```
public House getHouse() {
    return this.houseBuilder.getHouse();
}

public void constructHouse() {
    this.houseBuilder.buildBasement();
    this.houseBuilder.buildStructure();
    this.houseBuilder.bulidRoof();
    this.houseBuilder.buildInterior();
}}
```

v. IglooHouseBuilder Class:

```
package BuildingHouse;

public class IglooHouseBuilder implements HouseBuilder {

    private House house;

    public IglooHouseBuilder() {
        this.house = new House();
    }

    public void buildBasement() {
        house.setBasement("Ice Bars");
    }

    public void buildStructure() {
        house.setStructure("Ice Blocks");
    }

    public void buildInterior() {
        house.setInterior("Ice Carvings");
    }

    public void bulidRoof() {
        house.setRoof("Ice Dome");
    }
}
```

```
}  
  
public House getHouse() {  
    return this.house;  
}  
}}
```

vi. BuilderSample (Main Program)

```
package BuildingHouse;  
public class BuilderSample {  
    public static void main(String[] args) {  
        HouseBuilder iglooBuilder = new IglooHouseBuilder();  
        CivilEngineer engineer = new CivilEngineer(iglooBuilder);  
  
        engineer.constructHouse();  
  
        House house = engineer.getHouse();  
  
        System.out.println("Builder constructed: "+house);  
    }  
}
```

Comparison of Design Pattern of Creational Category:

Below is the chart which provides comparison of the design pattern discussed of creational category by comparing them in term of need for application, client knowledge and advantages /disadvantages.

	Factory Method	Builder	Proto type	Singleton
When to use	Need limited flexibility - choose from among a limited set of configurations	Don't want the details, want a configuration which will enable me to start working on it right away	Don't want the details, don't even want to pick what package I will get - it will probably be passed to me	Want to create only one of these - could be known to me, or could be passed to me
Client knowledge	More knowledge - client knows specific type, and knows about the internal configuration - it has to create them explicitly	Less knowledge of details, no knowledge of configuration	More knowledge of details, some knowledge of configuration - enough to make the right choice	Orthogonal to how much client has to know, but knowledge limited by the fact that most of the time, it uses an instance that already exists
Advantages/ Disadvantages	Reduced flexibility, High client knowledge	Reduced flexibility, minimal client knowledge	Good flexibility, minimal client knowledge	Variable flexibility, minimal client knowledge

LECTURE NO: 34

Objective:

In this lecture we will structural category of design pattern and will discuss adapter design pattern of structural category in detail with example.

Structural Design Pattern:

This category of design pattern deals with how classes and objects deal with to form large structures. Structural Design patterns use inheritance to compose interfaces or implementations to form the structure of larger systems. Structural Design Patterns basically ease the design by identifying the relationships between entities. Object-oriented patterns describe ways to compose objects to realize new functionality, possibly by changing the composition at run-time. Deal with objects delegating responsibilities to other objects. This behavior results in a layered architecture of components with low degree of coupling. They facilitate interobject communication when one object is not accessible to the other by normal means or when an object is not usable because of its incompatible interface.

Adapter or Wrapper Design Pattern:

Motivation:

The adapter pattern is adapting between classes and objects. Like any adapter in the real world it is used to be an interface, a bridge between two objects. In real world we have adapters for power supplies, adapters for camera memory cards, and so on. Probably everyone has seen some adapters for memory cards. If you cannot plug in the camera memory in your laptop you can use and adapter. You plug the camera memory in the adapter and the adapter in to laptop slot. That's it, it's really simple. What about software development? It's the same. Just imagine a situation when you have some class expecting some type of object and you have an object offering the same features, but exposing a different interface? Of course, you want to use both of them so you don't to implement again one of them, and you don't want to change existing classes, so why not create an adapter class for accessing the features. This could happen due to various reasons such as the existing interface may be too detailed, or it may lack in detail, or the terminology used by the interface may be different from what the client is looking for. The adapter is also responsible for transforming data into appropriate forms. For instance, if multiple boolean values are stored as

a single integer (i.e. flags) but your consumer requires a 'true'/false', the adapter would be responsible for extracting the appropriate values from the integer value. Another example is transforming the format of dates (e.g. YYYYMMDD to MM/DD/YYYY or DD/MM/YYYY).

Intent:

- i. Convert the interface of a class into another interface clients expect.
- ii. Adapter lets classes work together, that could not otherwise because of incompatible interfaces
- iii. Keeping the client code intact we need to write a new class which will make use of services offered by the class.

Adapter Pattern Defined:

“Adapter pattern convert the interface of the class into a form what client expects.

Adapter let the classes work together which couldn't otherwise due to incompatible interfaces.”

Applicability:

- i. We want to use the existing class and its interface does not match with the one you need.
- ii. In case of reusable classes due to Non-Compatible interfaces it is not possible to reuse them.

Class Diagram:

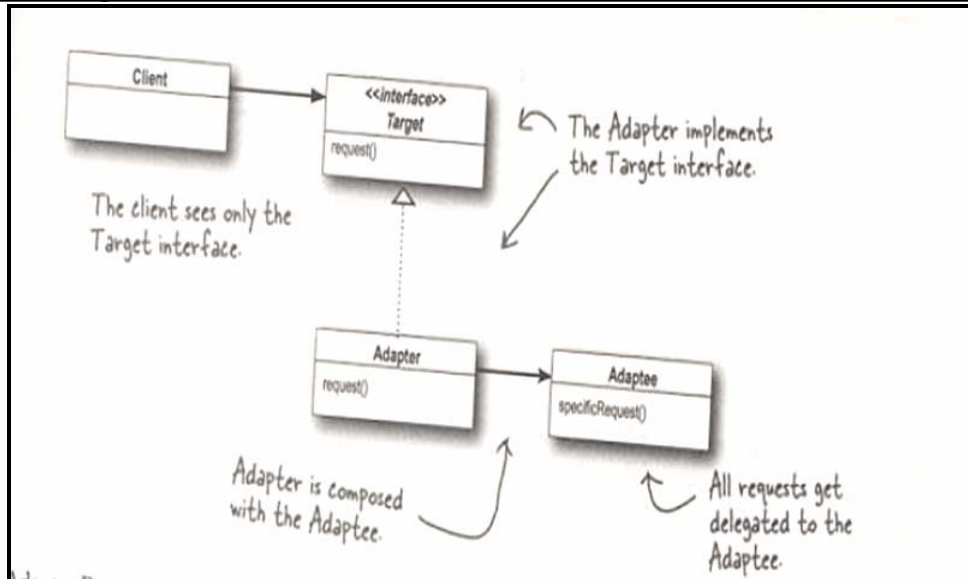

The classes/objects participating in adapter pattern:

- i. **Target** - defines the domain-specific interface that Client uses. This class is visible to the client and client will interact or pass request to this class.
- ii. **Adapter** - adapts the interface Adaptee to the Target interface.
- iii. **Adaptee** - defines an existing interface that needs adapting.
- iv. **Client** - collaborates with objects conforming to the Target interface.

Object Adapter:

Object Adapters (**discussed so far**) are the classical example of the adapter pattern. It uses composition; the Adapter delegates the calls to Adaptee (opposed to class adapters which extends the Adaptee). This behavior gives us a few advantages over the class adapters (however the class adapters can be implemented in languages allowing multiple inheritances). The main advantage is that the Adapter adapts not only the Adaptee but all its subclasses. All its subclasses with one "small" restriction: all the subclasses which don't add new methods, because the used mechanism is delegation. So for any new method the Adapter must be changed or extended to expose the new methods as well. The main disadvantage is that it requires writing all the code for delegating all the necessary requests to the Adaptee.

Class Adapters - Based on (Multiple) Inheritance

Class adapters can be implemented in languages supporting multiple inheritance (Java, C# or PHP does not support multiple inheritance). Thus, such adapters cannot be easily implemented in Java, C# or VB.NET.

Class adapter uses inheritance instead of composition. It means that instead of delegating the calls to the Adaptee, it subclasses it. In conclusion it must subclass both the Target and the Adaptee.

Class Diagram of Class Adapters:

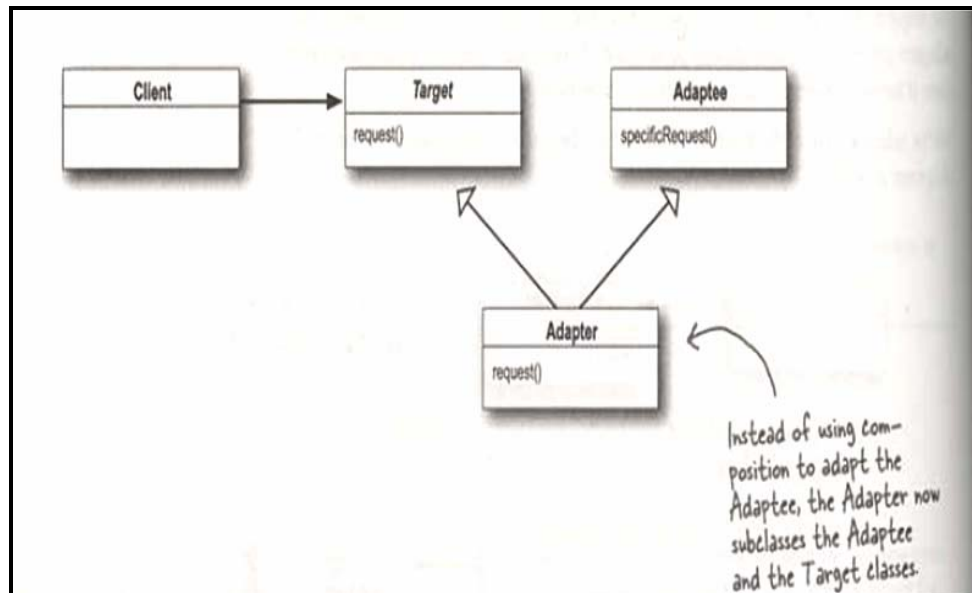

Advantages / Disadvantages of Class Adapters:

- i. It adapts the specific Adaptee class. The class it extends. If that one is subclassed it cannot be adapted by the existing adapter.
- ii. It doesn't require all the code required for delegation, which must be written for an Object Adapter.

If the Target is represented by an interface instead of a class then we can talk about "**class**" adapters, because we can implement as many interfaces as we want.

How Much to Adapt:

This question has a really simple response: it should do how much it has to in order to adapt. It's very simple, if the Target and Adaptee are similar then the adapter has just to delegate the requests from the Target to the Adaptee. If Target and Adaptee are not similar, then the adapter might have to convert the data structures between those and to implement the operations required by the Target but not implemented by the Adaptee.

Example

- Old world Enumerators
 - The early collections types of Java implement a method `elements()`, which returns an `Enumeration`.
- New world Iterators
 - Sun releases their recent `Collections` classes using an `Iteration`
- And today...
 - We are often faced with legacy code that exposes the `Enumeration` interface, yet we'd like for our new code to only use `Iterators`
 - We need to build an adapter....

```
<<interface>>
Enumeration
hasMoreElements()
nextElement()
```

```
<<interface>>
Iterator
hasNext()
next()
remove()
```

Writing the EnumerationIterator Adapter

```
public class EnumerationIterator implements Iterator {
    Enumeration enumeration;

    public EnumerationIterator(Enumeration enumeration) {
        this.enumeration = enumeration;
    }

    public boolean hasNext() {
        return enumeration.hasMoreElements();
    }

    public Object next() {
        return enumeration.nextElement();
    }

    public void remove() {
        throw new UnsupportedOperationException();
    }
}
```

LECTURE NO: 35

Objective:

In this lecture we will structural category of design pattern and will discuss facade design pattern of structural category in detail with example.

Façade Design Pattern

Motivation:

In real world applications, a subsystem could consist of a large number of classes. Clients of a subsystem may need to interact with a number of subsystem classes for their needs. This kind of direct interaction of clients with subsystem classes leads to a high degree of coupling between the client objects and the subsystem. Whenever a subsystem class undergoes a change, such as a change in its interface, all of its dependent client classes may get affected. A subsystem is a set of classes that work in conjunction with each other for the purpose of providing a set of related features (functionality). For example, an Account class, Address class and CreditCard class working together, as part of a subsystem, provide features of an online customer.

Intent:

- i. To provide a simple interface to use the complex sub systems to the users by keeping intact the functionality of subsystems
- ii. Power of subsystems will still be there but there will simplified access to the underlying subsystems.

Façade Pattern Defined:

“Façade provides a unified interface to a set of interfaces in a subsystem. It define a higher level interface which is easier to use”

Façade decouple the client from interacting with the subsystems instead Façade take up the responsibility of dealing with the subsystems itself. In effect, clients interface with the façade to deal with the subsystem. Thus the Façade pattern promotes a weak coupling between a subsystem and its clients Façade will not add any extra functionality it will just simply the access to functionality. Client can also access subsystems directly as if there is no Façade.

Following figures provide a graphical comparison of system access without and with facade

Client Access without Façade:

As shown below in the absence of façade, multiple clients are dealing with different classes that mean clients are aware of logic to interact with the underlying classes' i-e **high coupling**; which is not wanted or minimal coupling should be there between client and underlying system but the given scenario violate that rule. In such a scenario the responsibility of success of system is dependent heavily as to how client deal the underlying system.

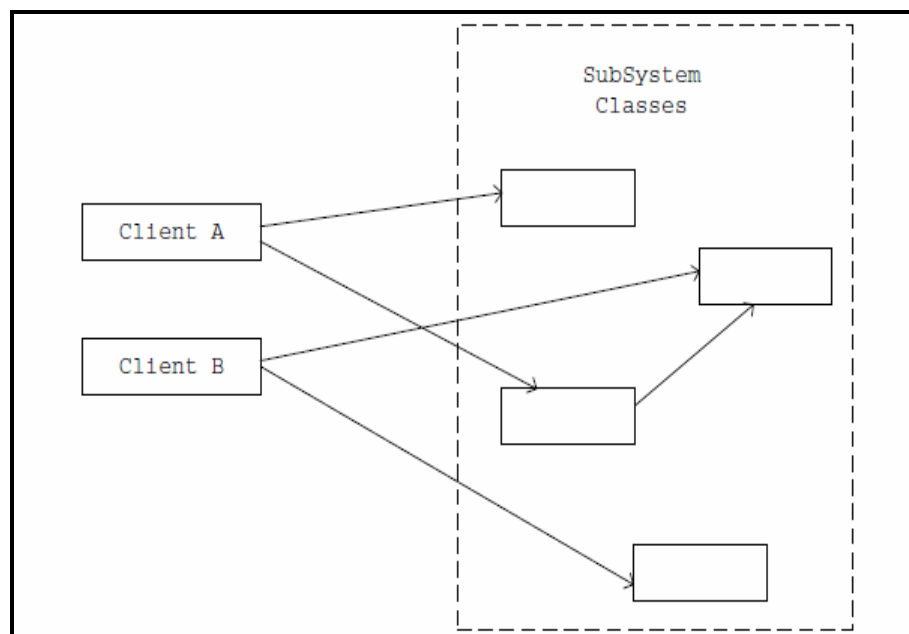

Client Access with Façade:

As shown in the figure below, can see that the Façade object decouples and shields clients from subsystem objects. When a subsystem class undergoes a change, clients do not get affected as before. Even though clients use the simplified interface provided by the façade, when needed, a client will be able to access subsystem components directly through the lower level interfaces of the subsystem as if the Façade object does not exist. In this case, they will still have the same dependency/coupling issue as earlier.

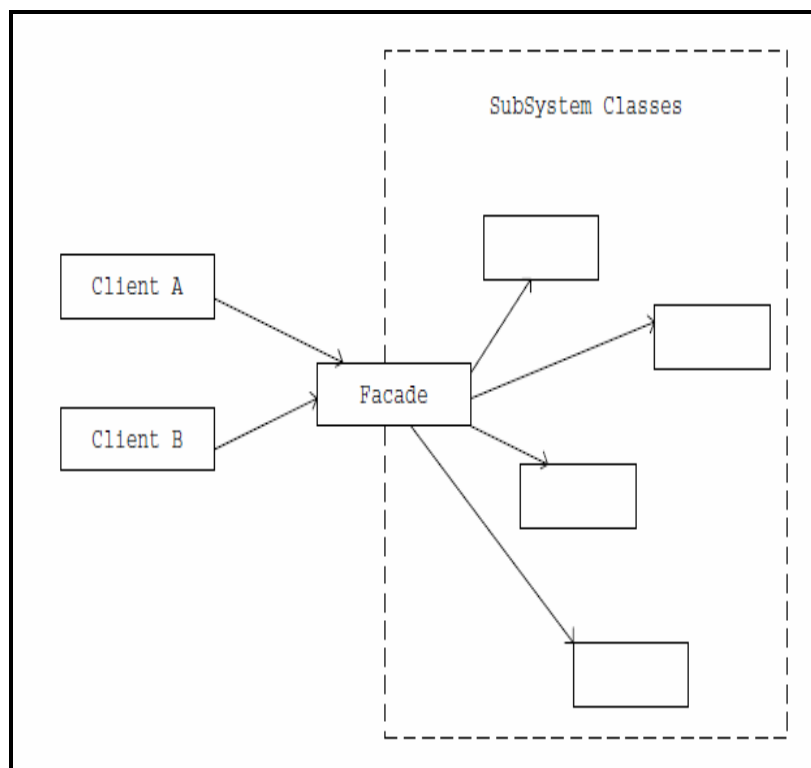

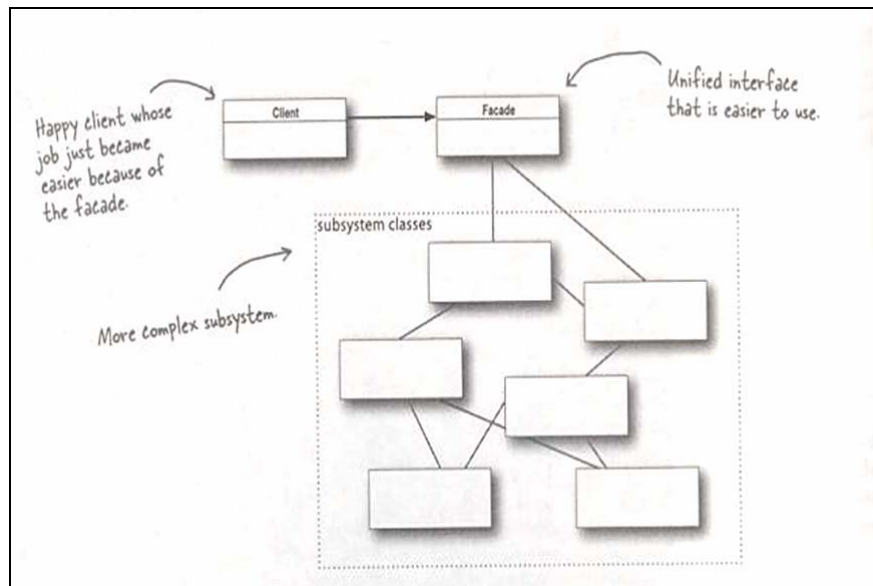
Class Diagram:**The Principle of Least Knowledge (PLK)**

“Talk only to your immediate friends”

OR

“For an operation O on a class C, only operations on the following objects should be called: itself, its parameters, objects it creates, or its contained instance objects”

The basic idea is to avoid calling any methods on an object where the reference to that object is obtained by calling a method on another object. Instead, this principle recommends we call methods on the containing object, not to obtain a reference to some other object, but instead to allow the containing object to forward the request to the object we would have formerly obtained a reference to. The primary benefit is that the calling method doesn't need to understand the structural makeup of the object its invoking methods upon. When creating software design for any object should be careful of the number of classes it is interacting with and how it will be interacting with them. With increase in number of classes it interacting reflects the complexity and mechanism to interact with classes reflect communication overhead which underlying is currently performing. This principle prevents us from creating designs that have a large number of

classes coupled together. When you build a lot of dependencies between many classes, you are building a system that will be costly to maintain and complex for others to understand.

Guidelines to Implement PLK:

Suppose we have an object with several methods, now for that object we should invoke methods only that belong to:

- i. An Object itself
- ii. Object passed in as a parameter
- iii. Any method that object creates or instantiates.
- iv. Any component of the Object

Example of PLK:

```

public class Car {
    Engine engine;
    // other instance variables

    public Car() {
        // initialize engine, etc.
    }

    public void start(Key key) {
        Doors doors = new Doors();

        boolean authorized = key.turns();

        if (authorized) {
            engine.start();
            updateDashboardDisplay();
            doors.lock();
        }
    }

    public void updateDashboardDisplay() {
        // update display
    }
}

```

Handwritten annotations explaining the code:

- Here's a component of this class. We can call its methods. (points to `Engine engine;`)
- Here we're creating a new object, its methods are legal. (points to `new Doors();`)
- You can call a method on an object passed as a parameter. (points to `key.turns();`)
- You can call a method on a component of the object. (points to `engine.start();`)
- You can call a local method within the object. (points to `updateDashboardDisplay();`)
- You can call a method on an object you create or instantiate. (points to `doors.lock();`)

Principle of Least Knowledge and Façade:

When we apply PLK to façade design pattern then it emerge that it is not rule of the thumb that there should be only one façade within a system. There can be several Façade within One Façade with the increase in complexity. We aim to maintain minimum possible communication with other classes but this does not stop us from defining multi-level façade or façade within façade to provide unified and simplified access to client of the underlying system.

Problem Statement:

For a typical online transaction oriented system, customer can perform transactions against an account i-e Pay pal etc; credit card validators are used for verifying the credentials of a client submitted by the client for checkout purposes. Address of the customer is also stored and checked for data entry checks for shipment purposes. Usually account, address and credit card subsystems works together to provide the feature of online transaction.

To Do Task:

Build an application using façade design pattern which perform the following tasks

- i. Accepts customer details (account, address and credit card details)
- ii. Validates the input data
- iii. Saves the input data to appropriate data files

Assuming there are three classes and each class is having its own validation and data storage mechanism

Sequence Diagram of the Problem Statement with Facade:

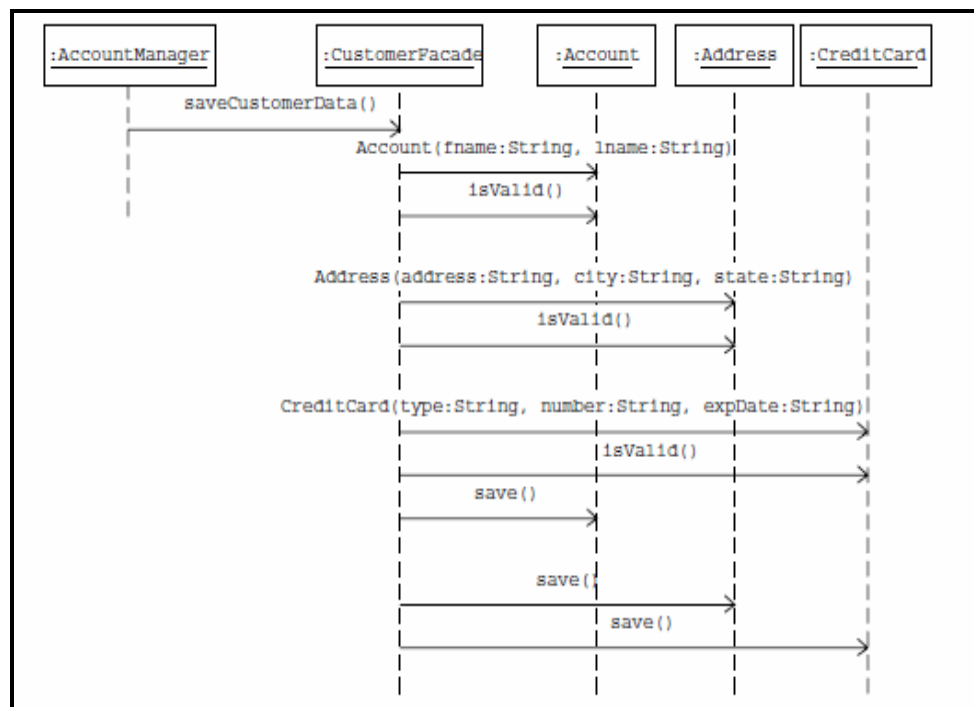

LECTURE NO: 36

Objective:

In this lecture we will structural category of design pattern and will discuss composite design pattern of structural category in detail with example.

Composite Design Pattern:

Motivation

This design pattern has a resemblance with concept of recursion or tree structure in data structures where every component is either a leaf node or composed of other nodes to make its next level. There are times when a program needs to manipulate a tree data structure and it is necessary to treat both Branches as well as Leaf Nodes uniformly.

Consider for example a program that manipulates a file system. A file system is a tree structure that contains Branches which are Folders as well as Leaf nodes which are Files. Note that a folder object usually contains one or more file or folder objects and thus is a complex object where a file is a simple object. Note also that since files and folders have many operations and attributes in common, such as moving and copying a file or a folder, listing file or folder attributes such as file name and size, it would be easier and more convenient to treat both file and folder objects uniformly by defining a File System Resource Interface. So the essence is that at times components are build using other components, we can classify component or object in one of the two categories —

- i. Individual Components – Leaf Node
- ii. Composite Components — which are composed of individual components or other composite components – Child Node(s)

Intent

- i. The intent of this pattern is to compose objects into tree structures to represent part-whole hierarchies' i-e **Aggregation**.
- ii. Composite lets clients treat individual objects and compositions of objects uniformly.

Here it would be pertinent that we can revisit the concept of tree structure of data structure as this design pattern deals with tree structure.

Tree Structure Revisited:

Tree is a data structure where there is a root, child and leaf nodes. There is only one root node in a tree, multiple child and leaf nodes. Child can have further nodes but leaf cannot have further nodes. Trees are a special case of a graph data structure. The connections radiate out from a single root without cross connections. The tree has nodes (shown with circles) that are connected with branches. Each node will have a parent node (except for the root) and may have multiple child nodes as shown below: Node A is a root node, b and C are child nodes, D,E and F are leaf nodes because they are having no further child nodes.

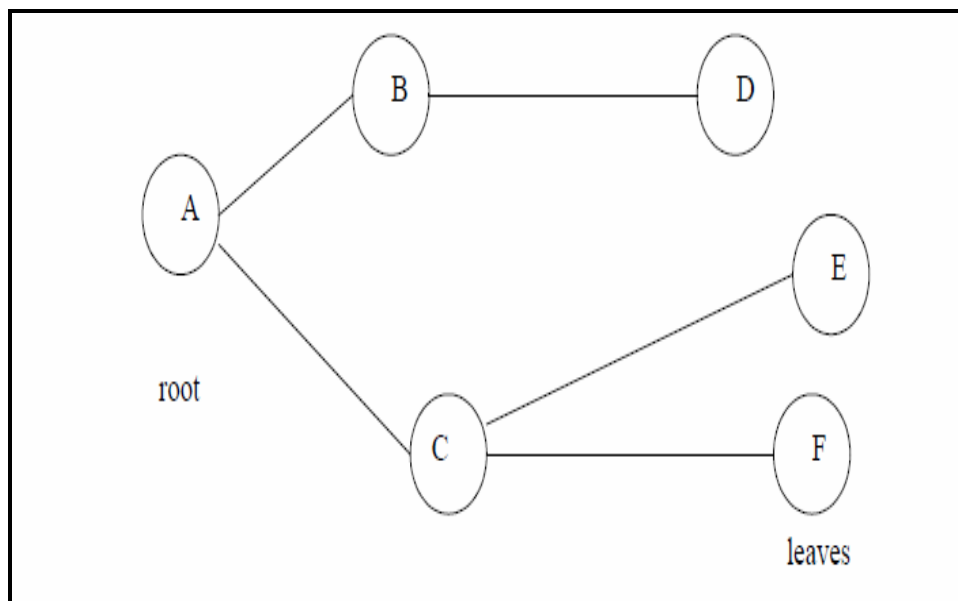

Composite Pattern Defined:

“Composite Design pattern allow us to compose objects into tree structures to represent whole-part hierarchy. It let the client handle the composite and individual components in a uniform manner”

Class Diagram:

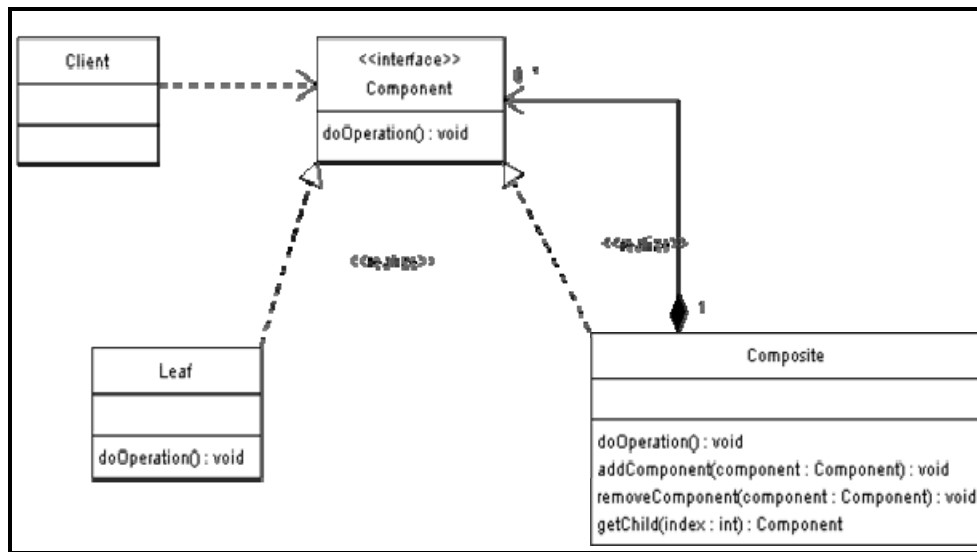

Description of Class Diagram and Application Flow:

- i. **Component** - Component is the abstraction for leafs and composites. It defines the interface that must be implemented by the objects in the composition. For example a file system resource defines move, copy, rename, and getSize methods for files and folders.
- ii. **Leaf** - Leafs are objects that have no children. They implement services described by the Component interface. For example a file object implements move, copy, rename, as well as getSize methods which are related to the Component interface.
- iii. **Composite** - A Composite stores child components in addition to implementing methods defined by the component interface. Composites implement methods defined in the Component interface by delegating to child components. In addition composites provide additional methods for adding, removing, as well as getting components.

- iv. **Client** - The client manipulates objects in the hierarchy using the component interface.

A client has a reference to a tree data structure and needs to perform operations on all nodes independent of the fact that a node might be a branch or a leaf. The client simply obtains reference to the required node using the component interface, and deals with the node using this interface; it doesn't matter if the node is a composite or a leaf.

Applicability

The composite pattern applies when there is a part-whole hierarchy of objects and a client needs to deal with objects uniformly regardless of the fact that an object might be a leaf or a branch.

Vectors in Java:

It is relevant to discuss vectors in java as we will be using this concept in the example. Vectors (the `java.util.Vector` class) are commonly used instead of arrays, because they expand automatically when new data is added to them. Vectors can hold only Objects and not primitive types (eg, `int`). If you want to put a primitive type in a Vector, put it inside an object (eg, to save an integer value use the `Integer` class or define your own class). If you use the `Integer` wrapper, you will not be able to change the integer value, so it is sometimes useful to define your own class. Vectors are implemented with an array, and when that array is full and an additional element is added, a new array must be allocated. Because it takes time to create a bigger array and copy the elements from the old array to the new array, it is a little faster to create a Vector with a size that it will commonly be when full. Of course, if you knew the final size, you could simply use an array. However, for non-critical sections of code programmers typically don't specify an initial size.

- i. **Create a Vector with default initial size**

```
Vector v = new Vector();
```

- ii. **Create a Vector with an initial size**

```
Vector v = new Vector(300);
```

- iii. **To Add elements to the end of a Vector:**

```
v.add(s);
```

iv. **To get element from a Vector:**

You can use a for loop to get all the elements from a Vector, but another very common way to go over all elements in a Vector is to use a ListIterator. The advantage of an iterator is that it can be used with other data structures, so that if you later change to using another data structure for example linkedlist, you won't have to change your code. Here is an example of using an iterator to print all elements (Strings) in a vector. The two most useful methods are **hasNext()**, which returns true if there are more elements, and **next()**, which returns the next element.

```
ListIterator iter = v.listIterator();  
While(iter.hasNext())  
{  
System.out.println((String)iter.next());  
}
```

Example with Code

Let us create an application to simulate the Windows/UNIX file system. The file system consists mainly of two types of components — directories and files. Directories can be made up of other directories or files, whereas files cannot contain any other file system component. In this aspect, directories act as nonterminal nodes and files act as terminal nodes or leaf node of a tree structure. The client will be able to calculate the size of file or folder irrespective of the internal representation of the storage mechanism.

Design Approach –I

Let us define a common interface for both directories and files in the form of a Java interface `FileSystemComponent`. The `FileSystemComponent` interface declares methods that are common for both file components and directory components. Let us further define two classes — `FileComponent` and `DirComponent` — as implementers of the common `FileSystemComponent` interface as shown:

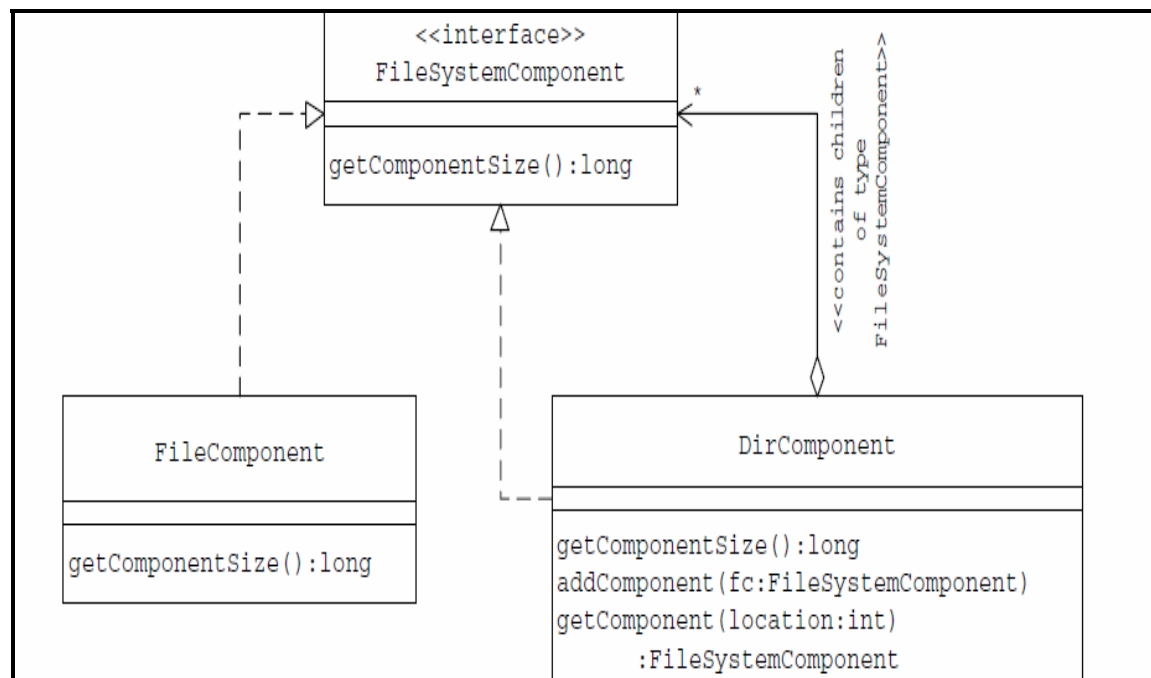

Processing of Class Diagram

A typical client would first create a set of FileSystemComponent objects (both DirComponent and FileComponent instances). It can use the addComponent method of the DirComponent to add different FileSystemComponents to a DirComponent, creating a hierarchy of file system (FileSystemComponent) objects.

Problem in current Approach:

When the client wants to query any of these objects for its size, it can simply invoke the GetComponentSize method. The client does not have to be aware of the calculations involved or the manner in which the calculations are carried out in determining the component size. In this aspect, the client treats both the FileComponent and the DirComponent object in the same manner. No separate code is required to query FileComponent objects and DirComponent objects for their size. Though the client treats both the FileComponent and DirComponent objects in a uniform manner in the case of the common GetComponentSize method, **it does need to distinguish when calling composite specific methods such as addComponent and GetComponent defined exclusively in the DirComponent. Because these methods are not available with FileComponent objects, the client needs to check to make sure that the FileSystemComponent object it is working with is in fact a DirComponent object.**

DESIGN APPROACH II:

The objective of this approach is to provide the same advantage of allowing the client application to treat both the composite DirComponent and the individual FileComponent objects in a uniform manner while invoking the `getComponentSize` method

Class Diagram of Design Approach-II

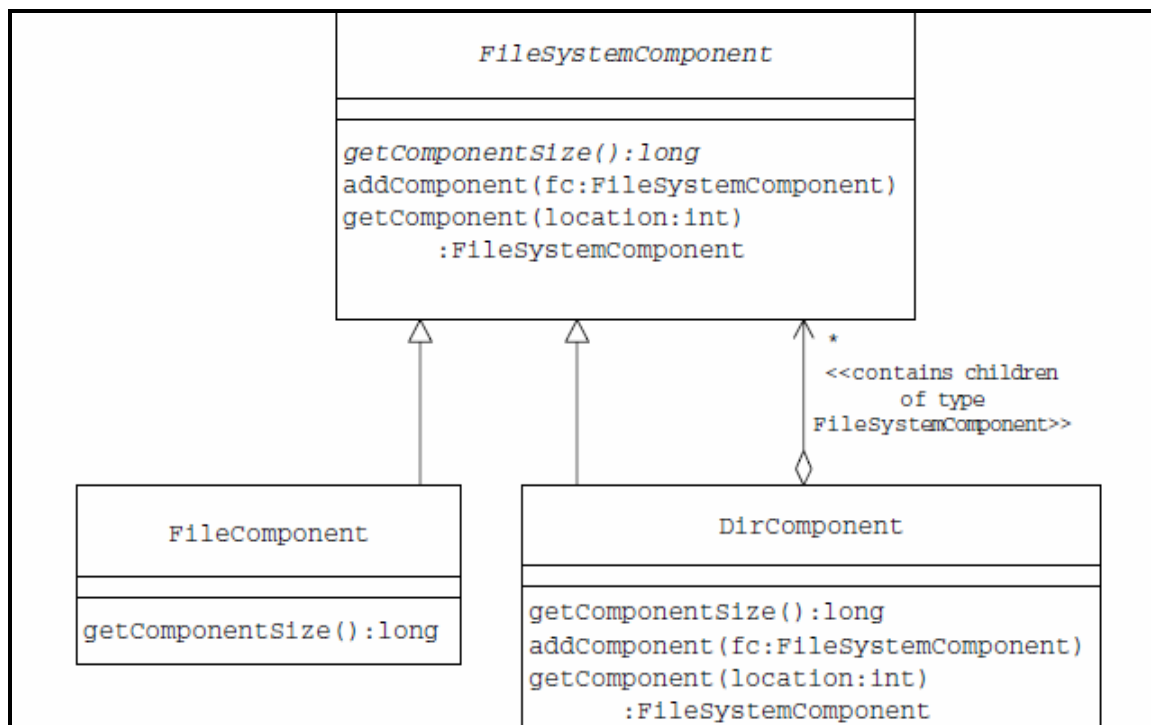

Design Approach –II Explained:

In the new design the composite-specific `addComponent` and `getComponent` methods are moved to the common interface `FileSystemComponent`. The `FileSystemComponent` provides the default implementation for these methods and is designed as an abstract class.

The default implementation of these methods consists of what is applicable to `FileComponent` objects. `FileComponent` objects are individual objects and do not contain other `FileSystemComponent` objects within. Hence, the default implementation does nothing and simply throws a custom `CompositeException` exception. The derived composite `DirComponent` class overrides these methods to provide custom implementation because there is no change in the way the common `getComponentSize` method is designed; the client will still be able to treat both the composite `DirComponent` and `FileComponent` objects identically. Because the common parent `FileSystemComponent` class now contains default implementations for the `addComponent` and the `getComponent` methods, the client application does not need to make any check before making a call to these composite-specific methods.

Java Code of the Example

```
package composite;
public abstract class FileSystemComponent {
    String name;
    public FileSystemComponent(String cName) {
        name = cName;
    }
    public void addComponent(FileSystemComponent component)
        throws CompositeException {
        throw new CompositeException("Invalid Operation. Not Supported");
    }
    public FileSystemComponent getComponent(int componentNum)
        throws CompositeException {
        throw new CompositeException("Invalid Operation. Not Supported");
    }
    public abstract long getComponentSize();
} //End of class FileSystemComponent
```

```
package composite;

public class FileComponent extends FileSystemComponent
{
private long size;
public FileComponent(String cName, long sz)
{
super(cName);
size = sz;
}
public long GetComponentSize()
{
return size;
}
} //End of class
```

```
package composite;
import java.util.Vector;
public class DirComponent extends FileSystemComponent
{
    Vector dirContents = new Vector();
    //individual files/sub folders collection
    public DirComponent(String cName)
    {
        super(cName);
    }
    public void addComponent(FileSystemComponent fc)
    throws CompositeException
    {
        dirContents.add(fc);
    }
    public FileSystemComponent getComponent(int location)
    throws CompositeException {
        return (FileSystemComponent) dirContents.elementAt(location);
    }
    public long getComponentSize()
    {
        long sizeOfAllFiles = 0;
        Enumeration e = dirContents.elements();
        while (e.hasMoreElements()) {
            FileSystemComponent component = (FileSystemComponent) e.nextElement();
            sizeOfAllFiles = sizeOfAllFiles + (component.getComponentSize());
        }
        return sizeOfAllFiles;
    }
}
} //End of class
```

Sample File Structure Used in the Main Program

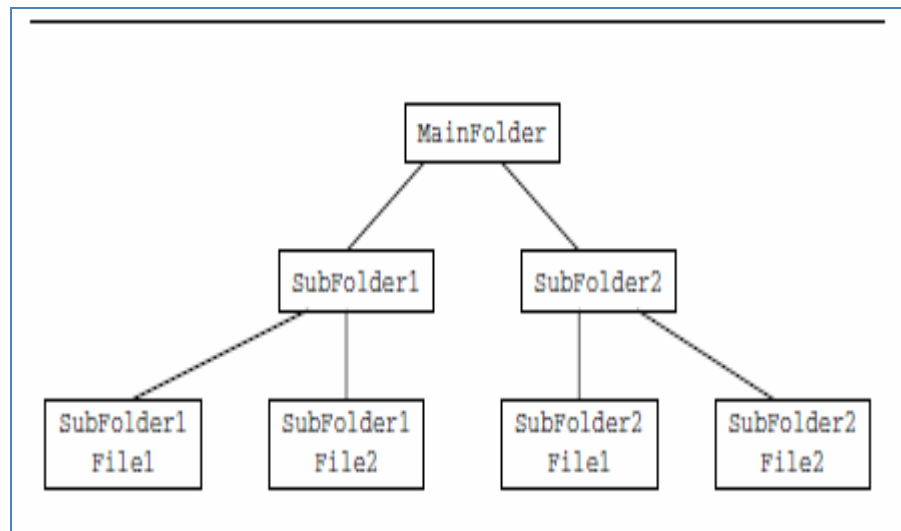

package composite;

public class CompositeDemo

{

public static final String SEPARATOR = ", ";

public static void main(String[] args) {

FileSystemComponent mainFolder = new DirComponent("Year2000");

FileSystemComponent subFolder1 = new DirComponent("Jan");

FileSystemComponent subFolder2 = new DirComponent("Feb");

//creating files

FileSystemComponent folder1File1 = new FileComponent("Jan1DataFile.txt",1000);

FileSystemComponent folder1File2 = new FileComponent("Jan2DataFile.txt",2000);

FileSystemComponent folder2File1 = new FileComponent("Feb1DataFile.txt",3000);

FileSystemComponent folder2File2 = new FileComponent("Feb2DataFile.txt",4000);

try {

mainFolder.addComponent(subFolder1);

```
mainFolder.addComponent(subFolder2);

subFolder1.addComponent(folder1File1);

subFolder1.addComponent(folder1File2);

subFolder2.addComponent(folder2File1);

subFolder2.addComponent(folder2File2);

} catch (CompositeException ex) {

//

}

//Client refers to both composite & //individual components in a uniform manner

System.out.println (" Main Folder Size= " + mainFolder.getComponentSize() + "kb");

System.out.println(" Sub Folder1 Size= " + subFolder1.getComponentSize() + "kb");

System.out.println(" File1 in Folder1 size= " + folder1File1.getComponentSize() + "kb");

}

}
```

LECTURE NO: 37

Objective:

In this lecture we will discuss Flyweight design pattern of the creational category of design pattern in detail with example.

Flyweight Design Pattern:

Motivation

There are cases when we design a system and program, where it seems that there is a need to generate a very large number of small class instances to represent data. Sometimes you can greatly reduce the number of different classes that you need to instantiate if you can recognize that the instances are fundamentally the same except for a few parameters. If you can move those variables outside the class instance and pass them in as part of a method call, the number of separate instances can be greatly reduced.

Generally speaking we can say that there are situations where there is a possibility of sharing the data among instances of classes but merely due to our overlooking of the commonality we define large number of classes to represent the similar data, so the essence is to focus more on sharing the data rather than creating more classes because as we define new classes the issue of maintaining these classes will require great effort. Every object can be viewed as consisting of one or both of the following two sets of information:

i. **Intrinsic Information or Shareable information:**

The intrinsic information of an object is independent of the object context. That means the intrinsic information is the common information that remains constant among different instances of a given class. For example, the company information on a visiting card is the same for all employees.

ii. **Extrinsic Information or Variant or Non-Shareable:**

The extrinsic information of an object is dependent upon and varies with the object context. That means the extrinsic information is unique for every instance of a given class. For example, the

employee name and title are extrinsic on a visiting card as this information is unique for every employee.

Consider an application scenario that involves creating a large number of objects that are unique only in terms of a few parameters. In other words, these objects contain some intrinsic, invariant data that is common among all objects. This intrinsic data needs to be created and maintained as part of every object that is being created. The overall creation and maintenance of a large group of such objects can be very expensive in terms of memory-usage and performance, in other words we are creating a heavyweight application with maintenance overhead. For example, if you are drawing a series of icons on the screen in a folder window, where each represents a person or data file, it does not make sense to have an individual class instance for each of them that remembers the person's name and the icon's screen position. Typically these icons are one of a few similar images and the position where they are drawn is calculated dynamically based on the window's size in any case.

Intent of Flyweight Design Pattern:

- i. To use sharing to support a large number of objects that have part of their internal state in common where the other part of state can vary.

Factory Pattern Defined:

“Facilitates the reuse of many fine grained objects, making the utilization of large numbers of objects more efficient”

Suggested Approach:

The Flyweight pattern suggests separating all the intrinsic common data into a separate object referred to as a *Flyweight* object. The group of objects being created can share the **Flyweight** object as it represents their intrinsic state. This eliminates the need for storing the same invariant, intrinsic information in every object; instead it is stored only once in the form of a single **Flyweight** object. As a result, the client application can realize considerable savings in terms of the memory-usage and the time.

Class Diagram:

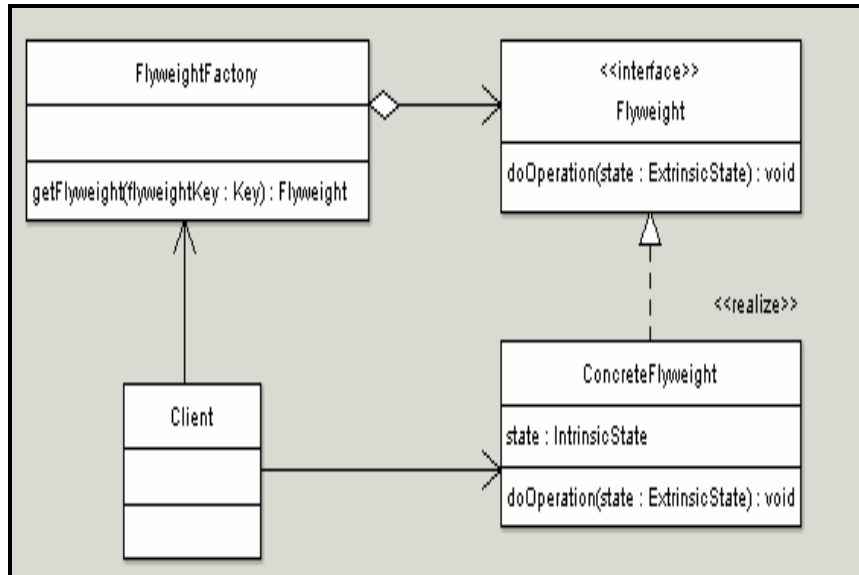

Description of Classes:

- i. **Flyweight** - Declares an interface through which flyweights can receive and act on extrinsic state.
- ii. **Concrete Flyweight** - Implements the Flyweight interface and stores intrinsic state. A Concrete Flyweight object must be sharable. The Concrete flyweight object must maintain state that is intrinsic to it, and must be able to manipulate state that is extrinsic.
- iii. **Flyweight Factory** - The factory creates and manages flyweight objects. In addition the factory ensures sharing of the flyweight objects. The factory maintains a pool of different flyweight objects and returns an object from the pool if it is already created, adds one to the pool and returns it in case it is new.
- iv. **Client** - A client maintains references to flyweights in addition to computing and maintaining extrinsic state

Flow of Application using Flyweight Design Pattern:

Flyweights are sharable instances of a class. It might at first seem that each class is a Singleton, but in fact there might be a small number of instances, such as one for every character, or one for every icon type. The number of instances that are allocated must be decided as the class instances are needed, and this is usually accomplished with a Flyweight Factory class. This factory class usually *is* a Singleton, since it needs to keep track of whether or not a particular instance has been generated yet. It then either returns a new instance or a reference to one it has already generated. A client needs a flyweight object; it calls the factory to get the flyweight object. The factory checks a pool of flyweights to determine if a flyweight object of the requested type is in the pool, if there is, the reference to that object is returned. If there is no object of the required type, the factory creates a flyweight of the requested type, adds it to the pool, and returns a reference to the flyweight. The flyweight maintains intrinsic state (state that is shared among the large number of objects that we have created the flyweight for) and provides methods to manipulate external state (State that vary from object to object and is not common among the objects we have created the flyweight for).

Factory and Singleton patterns:

Flyweights are usually created using a factory and the singleton is applied to that factory so that for each type or category of flyweights a single instance is returned.

Example:

We need to design for a war game in which there is a large number of soldier objects; a soldier object maintain the graphical representation of a soldier, soldier behavior such as motion, and firing weapons, in addition soldiers health and location on the war terrain. Creating a large number of soldier objects is a necessity however it would incur a huge memory cost.

Note that although the representation and behavior of a soldier is the same their health and location can vary greatly. The war game instantiates 5 Soldier clients, each client maintains its internal state which is extrinsic to the soldier flyweight, although 5 clients have been instantiated only one flyweight Soldier has been used.

Proposed Class Diagram

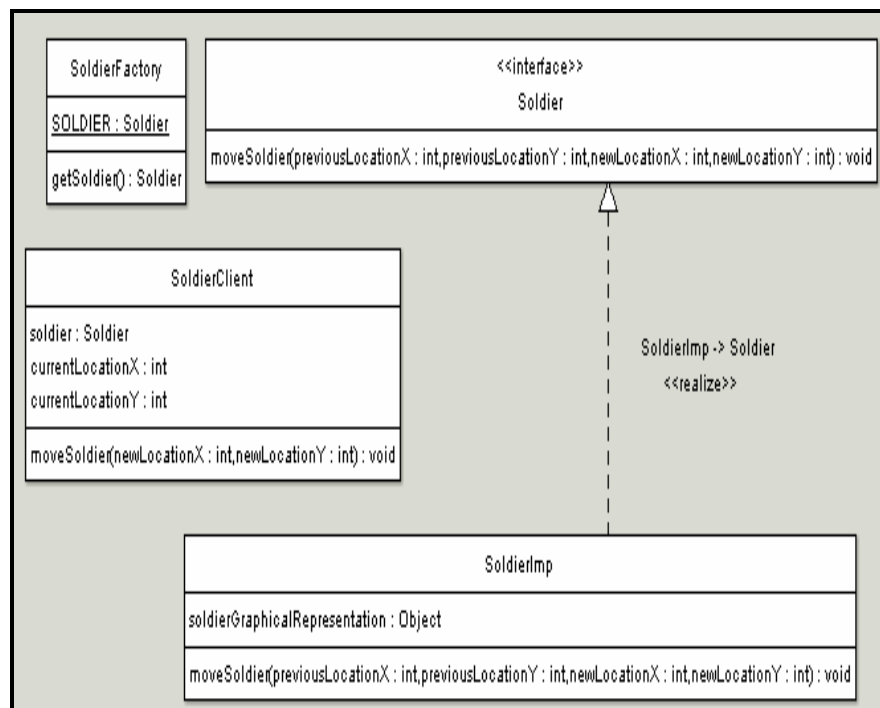

Java Code:

i. Soldier Interface

```
package flyweight;
```

```
/** * Flyweight Interface * */
```

```
public interface Soldier
```

```
{
```

```
/**
```

```
Move Soldier From Old Location to New Location Note that soldier location is extrinsic to the  
SoldierFlyweight Implementation */
```

```
public void moveSoldier(int previousLocationX, int previousLocationY , int newLocationX  
,int newLocationY);
```

```
}
```

ii. SoldierImp class

```
package flyweight;
```

```
public class SoldierImp implements Soldier {
```

```
/**
```

```
 *Intrinsic State maintained by flyweight implementation
```

```
 * Solider Shape ( graphical represetation)
```

```
 * how to display the soldier is up to the flyweight implementation
```

```
 */
```

```
private Object soldierGraphicalRepresentation;
```

```
/**
```

```
 * Note that this method accepts soldier location
```

```
 * Soldier Location is Extrinsic and no reference to previous location
```

```
 * or new location is maintained inside the flyweight implementation
```

```
 */
```

```
public void moveSoldier(int previousLocationX, int previousLocationY,int newLocationX,
```

```
int newLocationY)
```

```
{
```

```
// delete soldier representation from previous location
```

```
// then render soldier representation in new location
```

```
}
```

}

iii. SoldierFactory Class

```
package flyweight;

/**
 * Flyweight Factory
 */
public class SoldierFactory {

    /**
     * Pool for one soldier only
     * if there are more soldier types
     * this can be an array or list or better a HashMap
     */
    private static Soldier SOLDIER;

    /**
     * getFlyweight
     * @return
     */
    public static Soldier getSoldier(){

        // this is a singleton
        // if there is no soldier
        //This is singleton Design pattern usesge
        if(SOLDIER==null){

            // create the soldier
            SOLDIER = new SoldierImp();
        }

        // return the only soldier reference
        return SOLDIER;
    }
}
```

iv. SoldierClient Class

```
package flyweight;
```

```
/**
```

```
 * This is the "Heavyweight" soldier object which is the client of the flyweight soldier this object provides all soldier services and is used in the game */
```

```
public class SoldierClient {
```

```
    /**
```

```
     * Reference to the flyweight
```

```
    */
```

```
private Soldier soldier = SoldierFactory.getSoldier();
```

```
    /**
```

```
     * this state is maintained by the client
```

```
    */
```

```
private int currentLocationX = 0;
```

```
    /**
```

```
     * this state is maintained by the client
```

```
    */
```

```
private int currentLocationY=0;
```

```
public void moveSoldier(int newLocationX, int newLocationY)
```

```
{
```

```
    // here the actual rendering is handled by the flyweight object
```

```
    // this object is responsible for maintaining the state
```

```
    // that is extrinsic to the flyweight
```

```
soldier.moveSoldier(currentLocationX, currentLocationY, newLocationX, newLocationY);
```

```
currentLocationX = newLocationX;
```

```
currentLocationY = newLocationY;
```

}}

v. WarGame – Main class

```
package flyweight;
```

```
/**
```

```
 * Driver : War Game
```

```
 */
```

```
public class WarGame {
```

```
    public static void main(String[] args)
```

```
{
```

```
    // start war
```

```
    // draw war terrain
```

```
    // create 5 soldiers:
```

```
SoldierClient warSoldiers [] = {new SoldierClient(), new SoldierClient(),
```

```
                                new SoldierClient(),
```

```
                                new SoldierClient(),
```

```
                                new SoldierClient()};
```

```
    // move each soldier to his location
```

```
    // take user input to move each soldier
```

```
warSoldiers[0].moveSoldier(17, 2112);
```

```
    // take user input to move each soldier
```

```
warSoldiers[1].moveSoldier(137, 112);
```

```
    // note that there is only one SoldierImp (flyweight Imp)
```

```
    // for all the 5 soldiers
```

```
    // Soldier Client size is small due to the small state it maintains
```

```
    // SoldierImp size might be large or might be small
```

```
    // however we saved memory costs of creating 5 Soldier representations
```

```
    }
```

```
}
```

LECTURE NO: 38

Objective:

In this lecture we will discuss proxy design pattern of structural category in detail with example. We will also have an overview of RMI in relationship with proxy design pattern.

Proxy or Surrogate Design Pattern:

Motivation

As a name suggest, it is not the actual class to whom the client think it is dealing rather it is artificial class acting like original class for the client. Generally speaking a proxy is a person authorized to act for another person an agent or substitute the authority to act for another. There are situations in which a client does not or cannot reference an object directly, but wants to still interact with the object. A proxy object can act as the intermediary between the client and the target object. The proxy object has the same interface as the target object; it holds a reference to the target object and can forward requests to the target as required (**delegation!**).

In effect, the proxy object has the authority the act on behalf of the client to interact with the target object.

Sometimes we need the ability to control the access to an object. For example if we need to use only a few methods of some costly objects we'll initialize those objects when we need them entirely. Until that point we can use some light objects exposing the same interface as the heavy objects. These light objects are called **proxies** and they will instantiate those heavy objects when they are really need and by then we'll use some light objects instead. This ability to control the access to an object can be required for a variety of reasons: controlling when a costly object needs to be instantiated and initialized, giving different access rights to an object, as well as providing a sophisticated means of accessing and referencing objects running in other processes, on other machines.

Type of Proxies:

- i. **Virtual Proxies:** delaying the creation and initialization of expensive objects until needed, where the objects are created on demand
- ii. **Remote Proxies:** providing a local representation for an object that is in a different address space. A common example is Java RMI stub objects. The stub object acts as a

- proxy where invoking methods on the stub would cause the stub to communicate and invoke methods on a remote object (called skeleton) found on a different machine
- iii. **Protection Proxies:** where a proxy controls access to original object, by giving access to some objects while denying access to others.
 - iv. **Smart References:** providing a sophisticated access to certain objects such as tracking the number of references to an object and denying access if a certain number is reached, as well as loading an object from database into memory on demand.

Remote Method Innovation (RMI)

We will discuss the concept of RMI from view point of remote proxies. RMI is used when object of a class wants to access the method of another class but the other class is on the remote machine and to access the remote machine certain mechanism and protocol is to be followed. RMI basically highlight the protocol which govern the communication between object two remote machines. RMI is a multiple step communication protocol in which classes must implement certain interfaces to enable remote communication. Below are the classes along with its description:

Remote Interface — *A remote object must implement a remote interface* (one that extends `java.rmi.Remote`). A remote interface declares the methods in the remote object that can be accessed by its clients. In other words, the remote interface can be seen as the client's view of the remote object.

Remote Object — *A remote object is responsible for implementing the methods declared in the associated remote interface.*

RMI Registry — *RMI registry provides the storage area for holding different remote objects.* It is directory of remote objects with reference name which client can access

Client — *Client is an application object attempting to use the remote object.*

- – Can search for a remote object using a name reference in the RMI
- Registry. Once the remote object reference is found, it can invoke methods on this object reference.

RMIC Java RMI Stub Compiler:

- Once a remote object is compiled successfully, RMIC, the Java RMI stub compiler can be used to generate *stub and skeleton class files for the remote object*. *Stub and skeleton classes* are generated from the compiled remote object class. These stub and skeleton classes make it possible for a client object to access the remote object in a seamless manner.

Communication Mechanism:

In general, a client object cannot directly access a remote object by normal means. In order to make it possible for a client object to access the services of a remote object as if it is a local object, the RMIC-generated stub of the remote object class and the remote interface need to be copied to the client computer. The stub acts as a (Remote) proxy for the remote object and is responsible for forwarding method invocations on the remote object to the server where the actual remote object implementation resides. Whenever a client references the remote object, the reference is, in fact, made to a local stub. That means, when a client makes a method call on the remote object, it is first received by the local stub instance. The stub forwards this call to the remote server. On the server the RMIC generated skeleton of the remote object receives this call.

The whole process is shown in graphical way below:

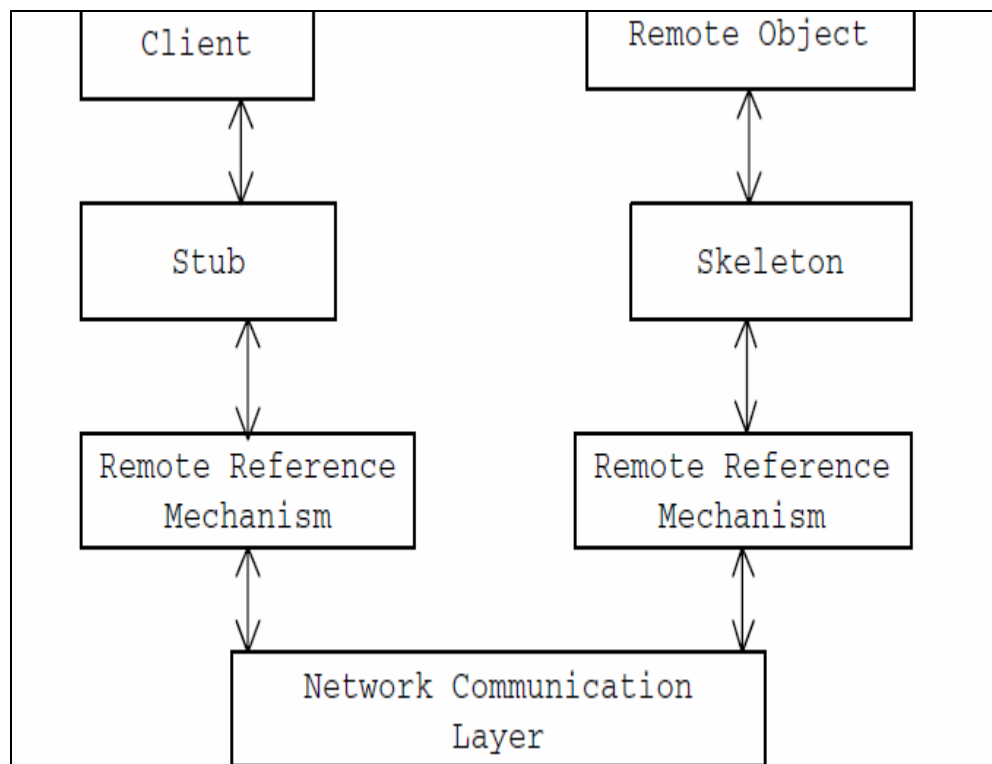

Intent

- The intent of this pattern is to provide a Placeholder for an object to control references to it.

Proxy Pattern Defined

“Proxy design pattern provides a surrogate or placeholder for another object to control access to it”

Class Diagram

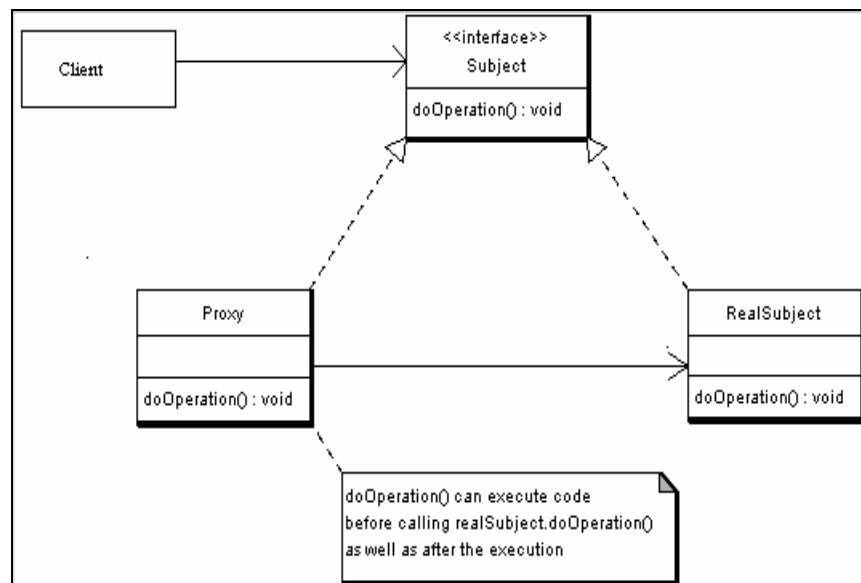

The participant's classes in the proxy pattern are:

- i. **Subject** - Interface implemented by the RealSubject and representing its services. The interface must be implemented by the proxy as well so that the proxy can be used in any location where the RealSubject can be used.
- ii. **Proxy** -Maintains a reference that allows the Proxy to access the RealSubject. It implements the same interface implemented by the RealSubject so that the Proxy can be

substituted for the RealSubject. It Controls access to the RealSubject and may be responsible for its creation and deletion.

- iii. **RealSubject** - the real object that the proxy represents.

Flow of Application

A client obtains a reference to a Proxy, the client then handles the proxy in the same way it handles RealSubject and thus invoking the method doSomething(). At that point the proxy can do different things prior to invoking RealSubjects doSomething() method. The client might create a RealSubject object at that point, perform initialization, check permissions of the client to invoke the method, and then invoke the method on the object. The client can also do additional tasks after invoking the doSomething() method, such as incrementing the number of references to the object.

Example

Consider an image viewer program that lists and displays high resolution photos. The program has to show a list of all photos however it does not need to display the actual photo until the user selects an image item from a list. We need to delay the instantiation of the high resolution photos till the time their loading is required by the application.

Solution:

Proposed Class Diagram

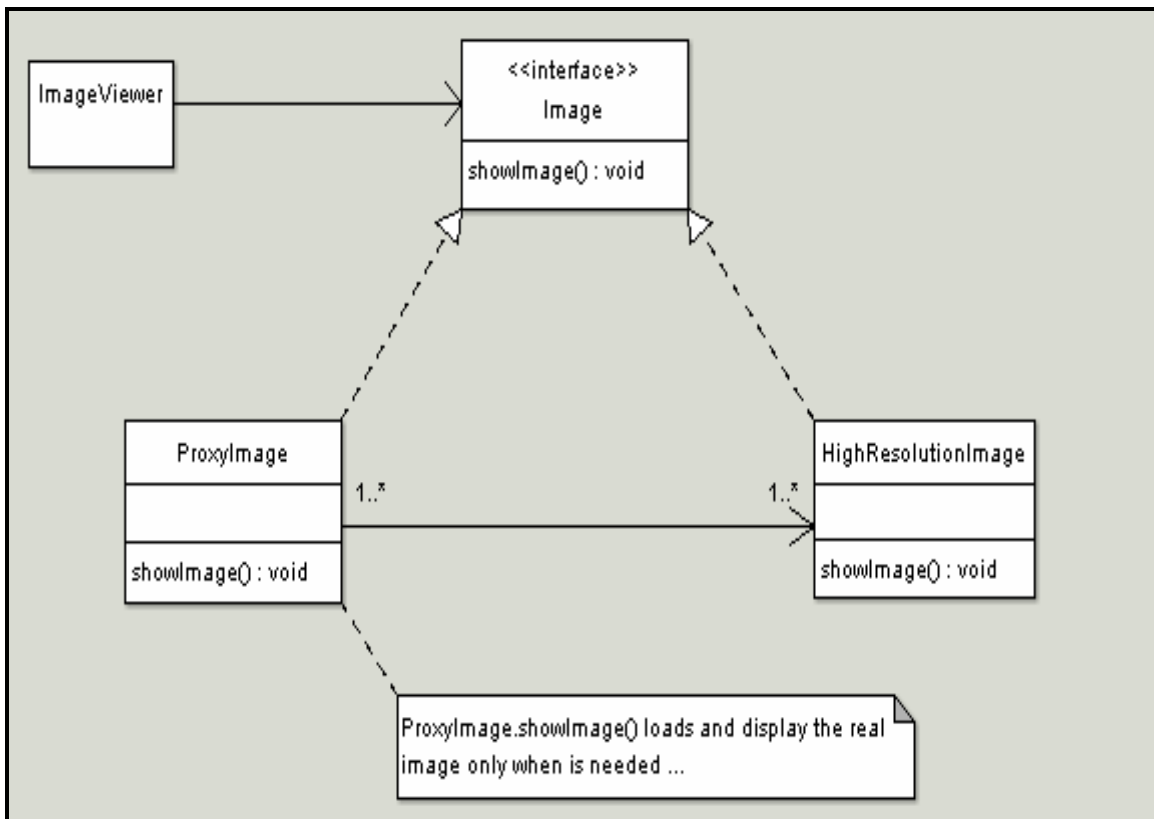

Java Code:

i. Image Interface:

The code below shows the Image interface representing the Subject. The interface has a single method showImage() that the Concrete Images must implement to render an image to screen.

```
package proxy;

/** * Subject Interface */

public interface Image

{

public void showImage();

}
```

ii. Image Proxy class

```
package proxy;

/** * Proxy */

public class ImageProxy implements Image

{

private String imageFilePath;

/** * Reference to RealSubject */

private Image proxifiedImage;

public ImageProxy(String imageFilePath)

{
```

```
this.imageFilePath= imagePath;
```

```
}
```

// Override the interface class method.

```
public void showImage() {
```

```
    // create the Image Object only when the image is required to be shown
```

```
    proxifiedImage = new HighResolutionImage(imageFilePath);
```

```
    // now call showImage on realSubject
```

```
    proxifiedImage.showImage();
```

```
}
```

```
}}
```

iii. HighResolutionImage Class – Real class.

```
package proxy;
```

```
/**
```

```
 * RealSubject
```

```
 */
```

```
public class HighResolutionImage implements Image {
```

```
    public HighResolutionImage(String imagePath) {
```

```
        loadImage(imageFilePath);
```

```
    }
```

```
    private void loadImage(String imagePath) {
```

```
        // load Image from disk into memory
```

```
        // this is heavy and costly operation
```

```
    }
```

```
    // override the method of interface class
```

```
    public void showImage() {
```

```
        // Actual Image rendering logic

    }
}
```

iv. ImageViewer – Main Program

```
package proxy;

/**
 * Image Viewer program
 */
public class ImageViewer {
    public static void main(String[] args) {

        // assuming that the user selects a folder that has 3 images
        //create the 3 images
        Image highResolutionImage1 = new ImageProxy("sample/veryHighResPhoto1.jpeg");
        Image highResolutionImage2 = new ImageProxy("sample/veryHighResPhoto2.jpeg");
        Image highResolutionImage3 = new ImageProxy("sample/veryHighResPhoto3.jpeg");

        // assume that the user clicks on Image one item in a list
        // this would cause the program to call showImage() for that image only
        // note that in this case only image one was loaded into memory
        highResolutionImage1.showImage();

        // consider using the high resolution image object directly
        Image highResolutionImageNoProxy1 = new HighResolutionImage("sample/veryHighResPhoto1.jpeg");
        Image highResolutionImageNoProxy2 = new HighResolutionImage("sample/veryHighResPhoto2.jpeg");
        Image highResolutionImageBoProxy3 = new HighResolutionImage("sample/veryHighResPhoto3.jpeg");

        // assume that the user selects image two item from images list
        highResolutionImageNoProxy2.showImage();

        // note that in this case all images have been loaded into memory
        // and not all have been actually displayed
        // this is a waste of memory resources
    }
}
```

}}

LECTURE NO: 39

Objective:

In this lecture we will discuss third category of design patterns i-e behavioral. We will discuss iterator design pattern in detail with example.

Behavioral Design Patterns:

In this category of design patterns we describe algorithms, assignment of responsibility, and interactions between objects (behavioral relationships) to form a structure of a particular design pattern. This category of design patterns use inheritance to distribute behavior and uses composition to form the larger structures of the classes. This category will shift the focus from flow of control to concentrate just on the way objects are interconnected. These patterns are concerned with the assignment of responsibilities between objects, or, encapsulating behavior in an object and delegating requests to it.

Iterator Design Pattern or Well Managed Collection

Iterator in Real-Life:

The Iterator provides ways to access elements of an aggregate object sequentially without exposing the underlying structure of the object. ! " On early television sets, a dial was used to change channels. When channel surfing, the viewer was required to move the dial through each channel position, regardless of whether or not that channel had reception. On modern television sets, a next and previous button are used. When the viewer selects the "next" button, the next tuned channel will be displayed. Consider watching television in a hotel room in a strange city. When surfing through channels, the channel number is not important, but the programming is. If the programming on one channel is not of interest, the viewer can request the next channel, without knowing its number.

Motivation of Iterator Design Pattern

There are different data structures to store data or objects in a collection i.e Array, Array list, Vector, stack, link list etc. In other words there are different containers which contain different object and to access the content of each container different mechanism is applied. Data is stored in the container and retrieved from it as of when needed. The motivation is to make the user free from the mechanism details which is being used to internally store the data and retrieve it.

The well known mechanism to store data are Arrays, Linked list, vectors; all of these mechanism are used to internally store the data but each one is having its own limitations and advantages. Besides providing data storage facility each mechanism also provides us with a data retrieval process through which we can retrieve the data from the container (Array, Vector) which provide ease to the user or programmer to easily traverse the container. We will focus on Arrays and Vectors in our discussion. The chart below provides are comparison between Array and Vector

Arrays are Static data structure	Vectors are dynamic data structure
Arrays are data type specific	Vector contains a dynamic list of references to other objects
Since size is fixed memory is allocated for array	Due to dynamic behavior Vectors are memory efficient way of storing data

There are two types of Iterators which are commonly used to access the data from the container:

- i. **Internal –Cursor**
- ii. **External**

i. **Internal Iterator – Cursor**

This type of iterator is also known as “**Cursor**”. The iterator itself offers methods to allow a client to visit different objects within the collection. For example, the `java.util.ResultSet` class contains the data and also offers methods such as `next()` to navigate through the item list. This means that object is having embedded methods attached to itself which are exposed to the programmer to be used for data access. `ResultSet` class provides the functionality for data access by providing data access methods to the programmer. We can summarize it by saying that data container and data retrieval are accessible through one object only.

ii. **External Iterator**

The iteration functionality is separated from the collection and kept inside a different object referred to as an *iterator*. Typical examples include `Vector` in which elements are stored inside vector but are traversed using `Enumeration` as shown below:

```
import java.util.*;
public class Program {
public static void main(String[] args)
{
Vector v = new Vector(); // Vector Declaration.
```

Adding elements to the vector.

```
v.add(0, "Apple");
v.add(1, "Orange");
v.add(2, "Banana");
```

//Assigning Vector to Iterator

```
Enumeration vEnum = v.elements();
while (vEnum.hasMoreElements())
```

```
{  
    System.out.println(vEnum.nextElement());  
}}
```

Intend of Iterator Design Pattern:

- Allows a client object to access the contents of a container in a sequential manner, without having any knowledge about the internal representation of its contents.
- Client should not be involved in the internal traversal of the contents of the container.

Iterator Design Pattern defined:

“The Iterator Design pattern provides a way to access the element of aggregate object sequentially without knowing its underlying representation”

Iterator Design Pattern in Detail

Iterator design pattern provides a uniform method of accessing elements of collection without knowing the underlying representation. We can write polymorphic code to access the elements of underlying aggregate objects. The idea is to take out the responsibility for access and traversal out of the collection and put them in the Iterator Object. Iterator class will define an interface for accessing the element of the collection. The abstraction provided by the Iterator pattern allows you to modify the collection implementation without making any changes outside of collection. It enables you to create a general purpose GUI component that will be able to iterate through any collection of the application.

Class Diagram

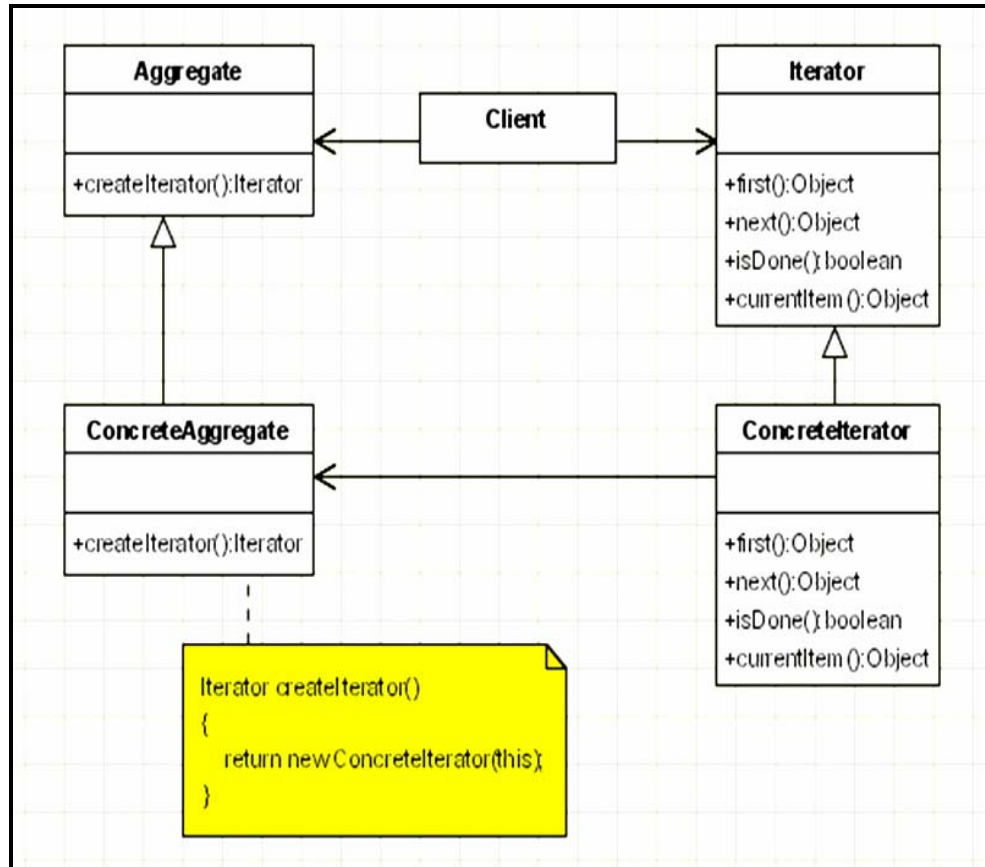

The Iterator pattern suggests that a Container object should be designed to provide a public interface in the form of an Iterator object for different client objects to access its contents. An Iterator object contains public methods to allow a client object to navigate through the list of objects within the container.

Classes in Class Diagram

Participants

- ⇒ Iterator
 - Defines an interface for accessing and traversing elements
- ⇒ ConcreteIterator
 - Implements the Iterator interface
 - Keeps track of the current position in the traversal
- ⇒ Aggregate
 - Defines an interface for creating an Iterator object (a factory method!)
- ⇒ ConcreteAggregate
 - Implements the Iterator creation interface to return an instance of the proper ConcreteIterator

Consequences:

i. Benefits

- i. Simplifies the interface of the Aggregate by not polluting it with traversal methods
- ii. Supports multiple, concurrent traversals
- iii. Supports variant traversal techniques

ii. Liabilities

- i. None!

Example:

This example is using a collection of books and it uses an iterator to iterate through the collection.

The problem is to store the books in the form of collection and then the items from the collections are needed to be retrieved from the container consistently.

Proposed Solution:

Java Code:

i. Iterator interface:

```
interface Iterator
{
    public boolean hasNext();
    public Object next();
}
```

ii. IContainer Interface

```
interface IContainer
{
    public Iterator createIterator();
}
```

iii. BooksCollection class

```
class BooksCollection implements IContainer
{
    private String m_titles[] = {"Design Patterns","1","2","3","4"};
```

```
public Iterator createIterator()
{
    BookIterator result = new BookIterator();
    return result;
}
```

iv. BookIterator Class

```
private class BookIterator implements Iterator
{
    private int m_position;

    public boolean hasNext()
    {
        if (m_position < m_titles.length)
            return true;
        else
            return false;
    }

    public Object next()
    {
        if (this.hasNext())
            return m_titles[m_position++];
        else
            return null;
    }
}
```

LECTURE NO: 40

Objective:

In this lecture we will discuss observer or publish and subscribe design pattern of behavioral category of design pattern. This design pattern will be discussed in details with the help of an example.

Observer or Publish and Subscribe Design Pattern:

Motivation

When we partition a system into a collection of cooperation classes, it is desired that consistent state between participating objects is to be maintained. This should be not achieved via tight coupling as against our basis design principle because for obvious reason this will reduce reusability but there should not a tradeoff on functionality. When there is flow or dependency of data among partitions of a system then it is necessary to find a mechanism or way through which we can achieve a consistent overall state of the system keeping in view the functionality.

In the chart given below there are 3 different representations of spreadsheet data (source) and as the source data is changed the representations are changed accordingly.

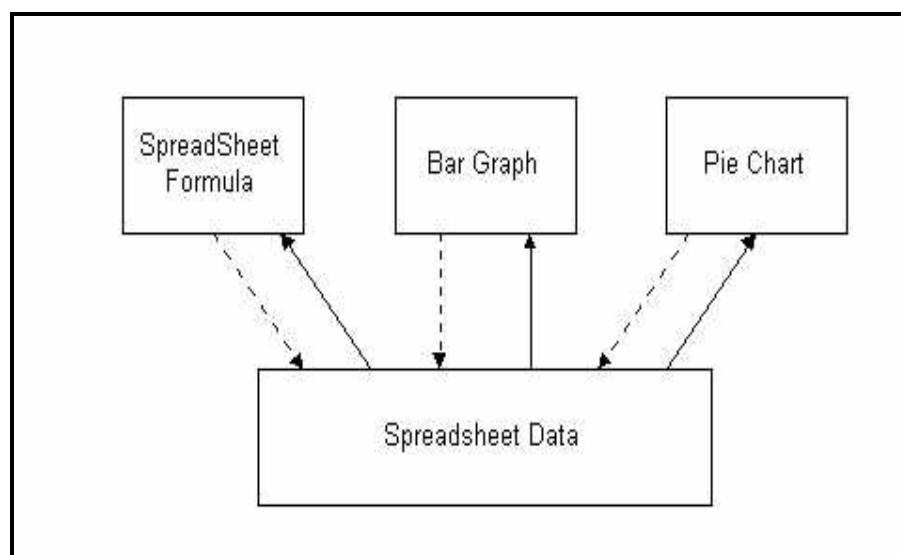

This diagram reflects the fact that Bar Graph and Pie Chart don't know about each other so that anyone can be reused independent of each other, but the interesting thing is that it seems that they know each other but this idea is very difficult to understand that how it is possible that two components don't know about each other. When the data in the spreadsheet (**source data**) is changed it is reflected in pie chart and bar graph also immediately. This behavior implies that they are dependent on data of the spreadsheet and whenever there is a change in spreadsheet pie chart and bar graph is notified to update the change. There seems to be no reason to believe that the number of objects representing the data is to be limited may be i-e may be line graph is to be used in future to represent data.

Observations about the Diagram:

If we observe the working of the diagram above we will point out that there exists a consistent communication model between a set of dependent objects and an object that they are dependent on. This allows the dependent objects to have their state synchronized with the object that they are dependent on. The set of dependent objects are referred to as *Observers i-e Graphs in our example*. The object on which Observer is dependent is referred to as the *subject. i-e Spreadsheet in our example*

Intent of Observer Design Pattern:

Define a one-to-many dependency between objects so that when one object changes state, all its dependents are notified and updated automatically.

Case for Observer Design Pattern

An aggregate object such as a list should give you a way to access its elements without exposing its internal structure. Moreover, you might want to traverse the list in different ways, depending on what you want to accomplish. But you probably don't want to bloat the List interface with operations for different traversals, even if you could anticipate the ones you will need. You might also need to have more than one traversal pending on the same list. The Iterator pattern lets you do all this. The key idea in this pattern is to take the responsibility for access and traversal out of the list object and put it into an iterator object. The Iterator class defines an interface for accessing the list's elements. An iterator object is responsible for keeping track of the current element; that is, it knows which elements have been traversed already. Observer pattern suggests a publisher-subscriber model leading to a clear boundary between the set of Observer objects and the Subject object. A typical observer is an object with interest or dependency in the state of the subject. The

subject cannot maintain a static list of such observers as the list of observers for a given subject could change dynamically. Hence any object with interest in the state of the subject needs to explicitly register itself as an observer with the subject. Whenever the subject undergoes a change in its state, it notifies all of its registered observers. Upon receiving notification from the subject, each of the observers queries the subject to synchronize its state with that of the subject's.

One-to-Many relationship

There is an explicit relationship between subject and its observer which is reflected from the scenario which contains a **one-to-many** relationship between a subject and the set of its observers. Each of the observer objects has to register itself with the subject to get notified when there is a change in the subject's state. We can say that subject will have the registered observers and it will be easy for the subject to notify the registered observer whenever it undergoes a change.

Observer Pattern Defined

“This pattern defines a one-to-many relationship between objects so that when there is change in the state of the one object it should be notified and automatically update it all dependent”.

Communication Protocol:

The **subject** should provide an interface for registering and unregistering for change notifications.

In the pull model — The subject should provide an interface that enables observers to query the subject for the required state information to update their state.

In the push model — The subject should send the state information that the observers may be interested in.

Class Diagram of Observer Design Pattern:

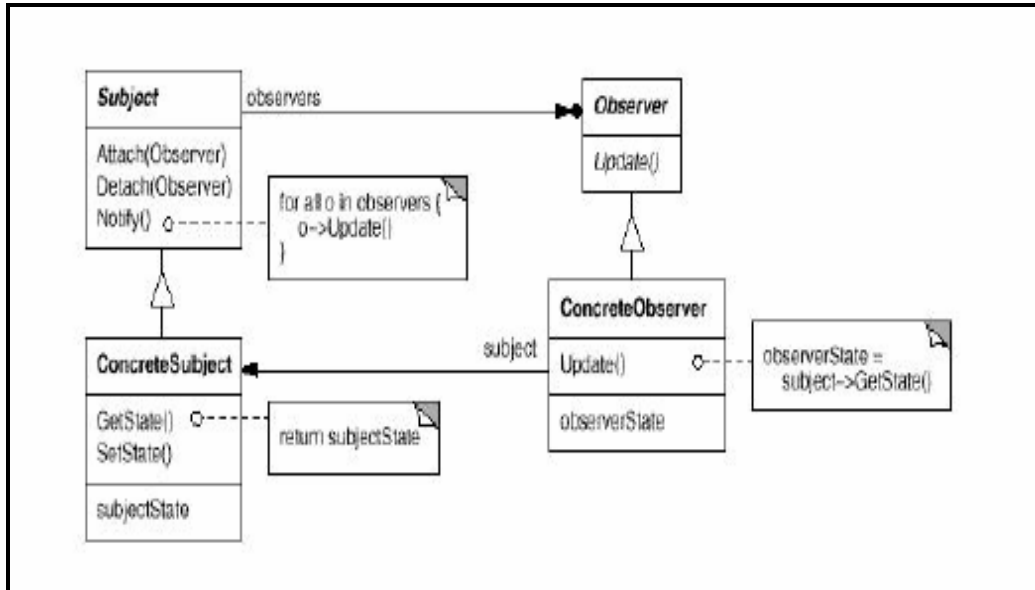

Participants in Class Diagram

i. Subject

This class will keep track of its observers and provides an interface for attaching and detaching Observer objects

ii. Observer

It defines an interface for update notification

iii. Concrete Subject

As discussed the object being observed will be object of this class, it stores state of interest to Concrete Observer objects. Its responsibility includes sending a notification to its observers when its state changes

iv. ConcreteObserver

This is object of class who is observing the subject class i.e. the observing object. This class stores state that should stay consistent with the subject's by implementing the Observer update interface to keep its state consistent with the subject's

Consequences:

- Support for event broadcasting
- Minimal coupling between the Subject and the Observer. Reuse observers without using subject and vice versa.

Liabilities:

- Possible cascading of notifications, Observers are not necessarily aware of each other and must be careful about triggering updates

Observer Design Pattern in Java:

- Java provides the Observable/Observer classes as built-in support for the Observer pattern.

Subject Class

The java.util.Observable class is the base **Subject class**.

- i. Any class that wants to be observed extends this class.
- ii. Provides methods to add/delete observers
- iii. Provides methods to notify all observers
- iv. A subclass only needs to ensure that its observers are notified in the appropriately
- v. Uses a Vector for storing the observer references

Observer Class:

The java.util.Observer interface is the Observer interface.

- i. This interface must be implemented by any observer class.

LECTURE NO: 41

Objective:

In this lecture we will discuss template method design pattern of behavioral category of design patterns. This design pattern will be discussed in details with the help of an example.

Template Method Design Pattern or Encapsulating Algorithms:

Motivation

If we take a look at the dictionary definition of a template we can see that a template is a preset format, used as a starting point for a particular application so that the format does not have to be recreated each time it is used. The Template Method pattern can be used in situations when there is an algorithm, some steps of which could be implemented in multiple different ways. Some portion of the solution is fixing for all the scenarios and some portion of the solution is specific to any situation. design patterns in object-oriented applications. The Template Method pattern can be used in situations when there is an algorithm, some steps of which could be implemented in multiple different ways. In such scenarios, the Template Method pattern suggests keeping the outline of the algorithm in a separate method referred to as a template method inside a class, which may be referred to as a template class, leaving out the specific implementations of the variant portions (steps that can be implemented in multiple different ways) of the algorithm to different subclasses of this class. The Template class does not necessarily have to leave the implementation to subclasses in its entirety. Instead, as part of providing the outline of the algorithm, the Template class can also provide some amount of implementation that can be considered as invariant across different implementations. It can even provide default implementation for the variant parts, if appropriate. Only specific details will be implemented inside different subclasses. This type of implementation eliminates the need for duplicate code, which means a minimum amount of code to be written.

Before we jump into the details of “Template method” design pattern, we will briefly discuss some of the concepts which are required in the discussion.

Final Method in Java:

In java when we want to restrict the subclass from overriding the super class method, we can declare that super class method a **“Final”** method so to keep those methods from overriding which are making outline of an algorithm.

Hollywood principle:

The **Hollywood principle** prevent us from what we call **“Dependency rot”** i-e high level components are dependent on low level components depending on high-level components depending on sideways components depending on low-level components and so on. When **“rot”** sets in it is very difficult to understand how the system is designed for execution.

With Hollywood principle in place, low-level components can be hooked themselves into the system but high-level components decided when they are needed. We can say that high level components give **“Don’t call us, we will call you”** treatment to the low-level components, as shown in the diagram below that low-level components can participate in computing but low-level components will never call high level components and on the top of all high-level component controls when and how to call the low-level components.

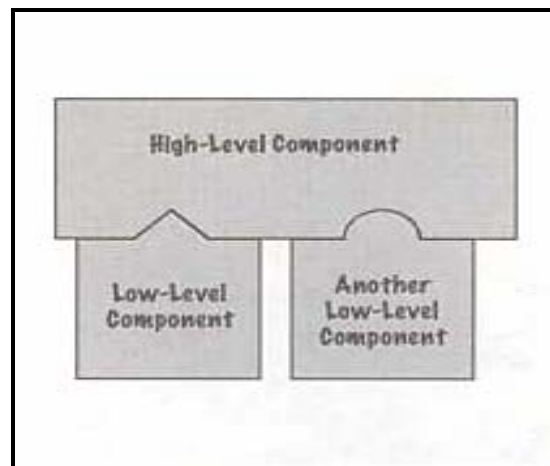

Hooks or Hot Spots:

The hooks are generally empty methods that are called in superclass (and does nothing because are empty), but can be implemented in subclasses. Due to this behavior hooks can plug themselves into various points in the algorithm if they wish too and beside that subclasses are free to ignore them. Customization Hooks can be considered a particular case of the template method as well as a totally different mechanism.

Intent of Template Method Design Pattern:

- Define the skeleton of an algorithm in an operation, deferring some steps to subclasses.
- Template Method lets subclasses redefine certain steps of an algorithm without letting them to change the algorithm's structure.

Class Diagram:

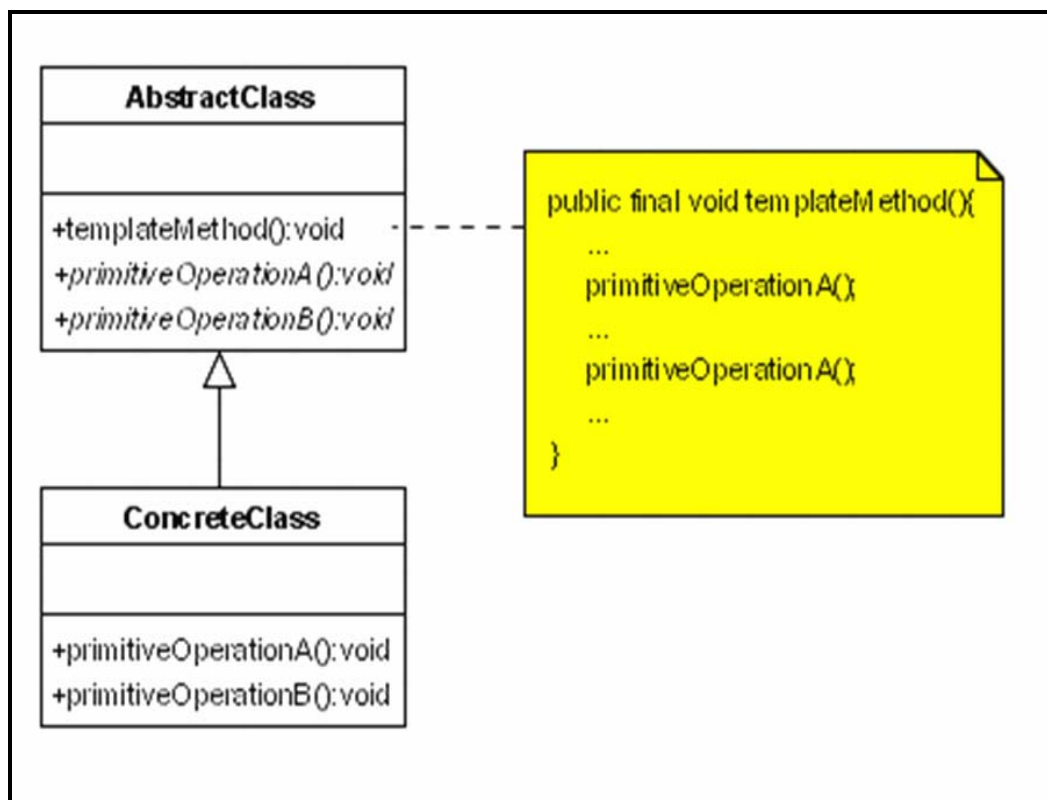

Participating classes

i. Abstract Class

This class defines abstract primitive operations that concrete subclasses define to implement steps of an algorithm.

ii. Concrete Class:

This class implements the primitive operations to carry out subclass-specific steps of the algorithm.

When a concrete class is called the template method code will be executed from the base class while for each method used inside the template method will be called the implementation from the derived class. The relationship between the Hollywood principle and template method pattern is somewhat clear because when we are designing with template method we are saying to the subclasses

“Don’t call us we will call you”

Example:

Lets' assume we have to develop an application for a travel agency. The travel agency is managing each trip. All the trips contain common behavior but there are several packages. For example each trip contains the basic steps:

- i. The tourists are transported to the holiday location by plane/train/ships.
- ii. Every day they are visiting some place.
- iii. They are returning back home.

Our task is to design and implement a system which should simulate the mentioned requirements.

Proposed Class Diagram of Solution

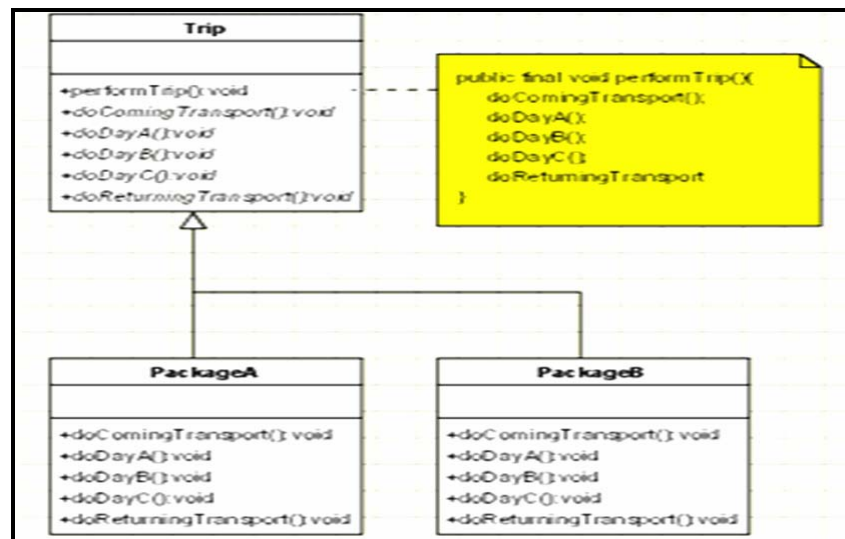

Java Code

i. Trip Class

```
public class Trip {

// This method can't be overridden by the sub class but we are calling abstract method inside it.
//This will keep intact the outline of the algorithm.

    public final void performTrip(){
        doComingTransport();
        doDayA();
        doDayB();
        doDayC();
        doReturningTransport
    }
    public abstract void doComingTransport();
    public abstract void doDayA();
    public abstract void doDayB();
    public abstract void doDayC();
    public abstract void doReturningTransport();
}
```

ii. PackageA class

```
public class PackageA extends Trip
{
    public void doComingTransport()
    {
        System.out.println("The tourists are coming by air ...");
    }
    public void doDayA() {
        System.out.println("The tourists are visiting the garden ...");
    }
}
```

```
public void doDayB() {  
    System.out.println("The tourists are going to the museum ...");  
}  
public void doDayC() {  
    System.out.println("The tourists are going to mountains ...");  
}
```

```
public void doReturningTransport() {  
    System.out.println("The tourists are going home by air ...");  
}}
```

iii. PackageB class

```
public class PackageB extends Trip {  
    public void doComingTransport() {  
        System.out.println("The tourists are comming by train ...");  
    }  
    public void doDayA() {  
        System.out.println("The tourists are visiting the mountain ...");  
    }  
    public void doDayB() {  
        System.out.println("The tourists are going to the olympic stadium ...");  
    }  
    public void doDayC() {  
        System.out.println("The tourists are going to zoo ...");  
    }  
    public void doReturningTransport() {  
        System.out.println("The tourists are going home by train ...");  
    }  
}
```

LECTURE NO: 42

Objective:

In this lecture we will discuss memento design pattern of behavioral category of design patterns. This design pattern will be discussed in details with the help of an example.

Memento or Souvenir Design Pattern:

Motivation

Consider the case of a calculator object with an undo operation such a calculator could simply maintain a list of all previous operation that it has performed and thus would be able to restore a previous calculation it has performed. This would cause the calculator object to become larger, more complex, and heavyweight, as the calculator object would have to provide additional “**undo functionality**” and should maintain a list of all previous operations. The state of an object can be defined as the values of its properties or attributes at any given point of time. It is sometimes necessary to capture the internal state of an object at some point and have the ability to restore the object to that state later in time. The Memento pattern is useful for designing a mechanism to capture and store the state of an object so that subsequently, when needed, the object can be put back to this (previous) state. This is more like an “**Undo operation**” as discussed above. The Memento pattern can be used to accomplish “**Undo Operation**” without exposing the object’s internal structure.

Intent of Memento Design Pattern:

- The intent of this pattern is to capture the internal state of an object without violating encapsulation and thus providing a mean for restoring the object into initial state when needed.

Concepts in Memento:

i. Originator

The object whose state needs to be captured is referred to as the *originator*. When a client wants to save the state of the originator, it requests the current state from the originator.

ii. Memento Object

The originator stores all those attributes that are required for restoring its state in a separate object referred to as a *Memento* and returns it to the client. Thus a Memento can be viewed as an object that contains the internal state of another object, at a given point of time. A Memento object must hide the originator variable values from all objects except the originator. In other words, it should protect its internal state against access by objects other than the originator. Memento should be designed to provide restricted access to other objects while the originator is allowed to access its internal state. When the client wants to restore the originator back to its previous state, it simply passes the memento back to the originator. The originator uses the state information contained in the memento and puts itself back to the state stored in the Memento object.

Roles in Memento Design Pattern:

- i. **Originator** - the object that knows how to save itself.
- ii. **Caretaker** - the object that knows why and when the Originator needs to save and restore itself.
- iii. **Memento** - the lock box that is written and read by the Originator, and shepherd by the Caretaker.

Class Diagram

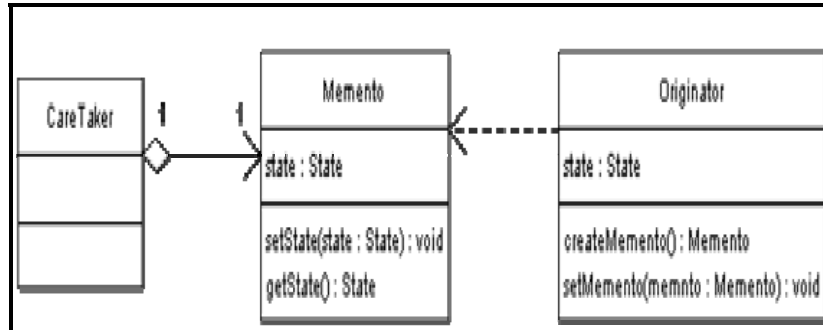

Participating Classes:

i. Memento

This class stores internal state of the Originator object. The state can include any number of state variables. The Memento must have two interfaces, an interface to the caretaker. This interface must not allow any operations or any access to internal state stored by the memento and thus honors encapsulation. The other interface is to the originator and allows the originator to access any state variables necessary to for the originator to restore previous state.

ii. Originator

It creates a memento object capturing the originators internal state; it then uses the memento object to restore its previous state.

iii. Caretaker

This class is responsible for keeping the memento. The memento is opaque to the caretaker, and the caretaker must not operate on it.

Processing of the Class

A Caretaker would like to perform an operation on the Originator while having the possibility to rollback. The caretaker calls the create Memento () method on the originator asking the originator to pass it a memento object. At this point the originator creates a memento object saving its internal state and passes the memento to the caretaker. The caretaker maintains the memento object and performs the operation. In case of the need to undo the operation, the caretaker calls the set Memento () method on the originator passing the maintained memento object. The originator would accept the memento, using it to restore its previous state.

Database Transactions and Memento Design Pattern:

Transactions are operations on the database that occur in an **atomic, consistent, durable, and isolated fashion**. A transaction can contain multiple operations on the database; each operation can succeed or fail, however a transaction guarantees that if all operations succeed, the transaction would commit and would be final. And if any operation fails, then the transaction would fail and all operations would rollback and leave the database as if nothing has happened. This mechanism of rolling back uses the memento design pattern.

Consider an object representing a database table, a transaction manager object which is responsible of performing transactions must perform operations on the table object while having the ability to undo the operation if it fails, or if any operation on any other table object fails. To be able to rollback, the transaction manager object would ask the table object for a memento before performing an operation and thus in case of failure, the memento object would be used to restore the table to its previous state.

Consequences

Memento protects encapsulation and avoids exposing originator's internal state and implementation. It also simplifies originator code such that the originator does not need to keep track of its previous state since this is the responsibility of the Caretaker.

Using the memento pattern can be expensive depending on the amount of state information that has to be stored inside the memento object. In addition the caretaker must contain additional logic to be able to manage mementos.

Example:

Let's use a simple example in Java to illustrate this pattern. As it's a pattern used for undo frameworks, we'll model an editor. First, the memento needs to be able to save editor contents, which will just be plain text:

//Memento

```
public class EditorMemento
{
    private final String editorState;

    public EditorMemento(String state)
    {
        editorState = state;
    }

    public String getSavedState()
    {
        return editorState;
    }
}
```

Now our Originator class, the editor, can use the memento:

//Originator Class

```
public class Editor
{
    //state
    public String editorContents;
```

```
public void setState(String contents)
{
    this.editorContents = contents;
}

public EditorMemento save()
{
    return new EditorMemento(editorContents);
}

public void restoreToState(EditorMemento memento)
{
    editorContents = memento.getSavedState();
}}
```

Anytime we want to save the state, we call the `save()` method, and an undo would call the `restoreToState` method. Our caretaker can then keep track of all the memento's in a stack for the undo framework to work.

LECTURE NO: 43

Objective:

In this lecture we will discuss last pattern of the course and of the behavioral category, command design pattern. This design pattern will be discussed in details with the help of an example.

Command or Encapsulating Invocation Design Pattern

“An object that contains a symbol, name or key that represents a list of commands, actions or keystrokes”. This is the definition of a macro, one that should be familiar to any computer user. From this idea the Command design pattern was given birth. The Macro represents, at some extent, a command that is built from the reunion of a set of other commands, in a given order.

In general, an object-oriented application consists of a set of interacting objects each offering limited, focused functionality. In response to user interaction, the application carries out some kind of processing. For this purpose, the application makes use of the services of different objects for the processing requirement. In terms of implementation, the application may depend on a designated object that invokes methods on these objects by passing the required data as arguments.

Concepts in Command Design Pattern

i. Invoker:

As mention previously, an application is build using the functionality of other objects; in programming term it means that there should be some object which invokes the methods of other classes for its own processing. In command design pattern the designated object that invokes operations on different objects is known as **“Invoker”** and it is considered as a part of client application. This is basically a request object which is sending request messages to the classes where actual implementation lies.

ii. Receiver:

The set of objects that actually contain the implementation to offer the services required for the request processing can be referred to as *Receiver* objects. In programming sense we can say this

response objects because it sends data against a particular request which is send by invoker object as mention above.

The graphical representation of the working of “**Invoker**” and “**Receiver**” is shown below:

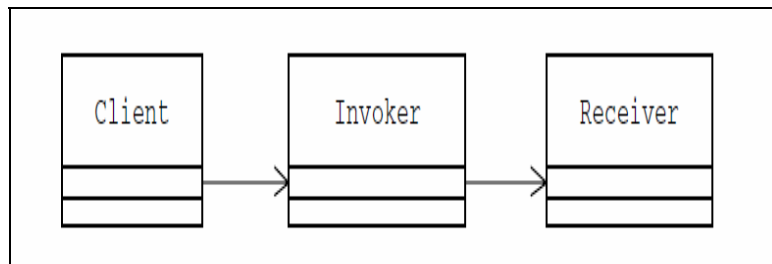

In this design, the application that forwards the request and the set of Receiver objects that offer the services required to process the request are closely tied to each other in that they interact with each other directly. This could result in a set of conditional if statements in the implementation of the **invoker** as shown below:

```

if (RequestType=TypeA)
{
//do something
}
// Adding a new Type
if (RequestType=TypeB)
{
//do something
}
  
```

As we can see above in the code of “**Adding a new Type**” , we have to open the existing class add new code in it, we can do it but this is clear violation of “**Open/Close Principle**” and other problem is that since invoker is a part of client we are relying on client for successful implementation of the application by giving him access to the code, in other words we can say that this design “**Tightly Coupled**” which is again another violation of design principle.

Suggested Solution:

The invoker that issues a request on behalf of the client and the set of service-rendering Receiver objects can be decoupled. Create an abstraction for the processing to be carried out or the action to be taken in response to client requests.

Intent of Command Design Pattern:

- To encapsulate a request in an object.
- To allow the parameterization of clients with different requests.
- To allow saving the request in a queue.
- Promote “invocation of a method on an object” to full object status.

Command Object

The Command pattern suggests creating an abstraction for the processing to be carried out or the action to be taken in response to client requests. This abstraction can be designed to declare a common interface to be implemented by different concrete implementers referred to as *Command objects*. Each Command object represents a different type of client request and the corresponding processing as shown below:

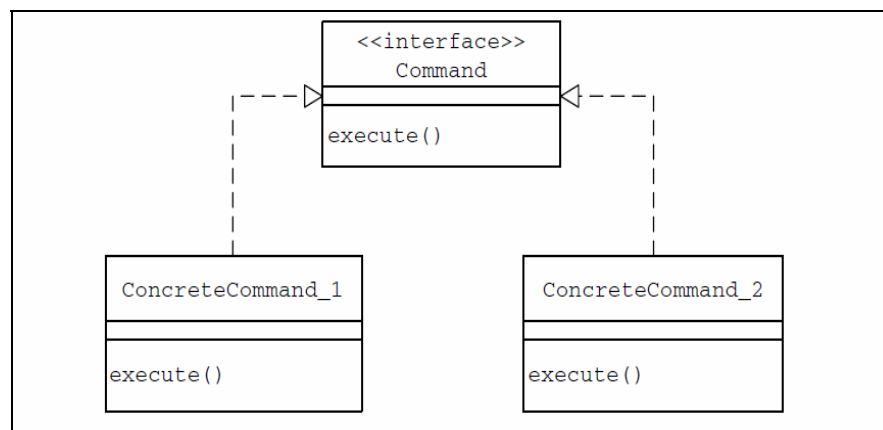

A given Command object (**Interface class**) is responsible for offering the functionality required to process the request it represents, but it does not contain the actual implementation of the functionality. It makes use of receiver objects in offering this functionality.

Command Pattern Defined:

“It encapsulates a request as an object thereby letting you parameterize other objects with different requests queue or log request and support undoable operations”

Class Diagram

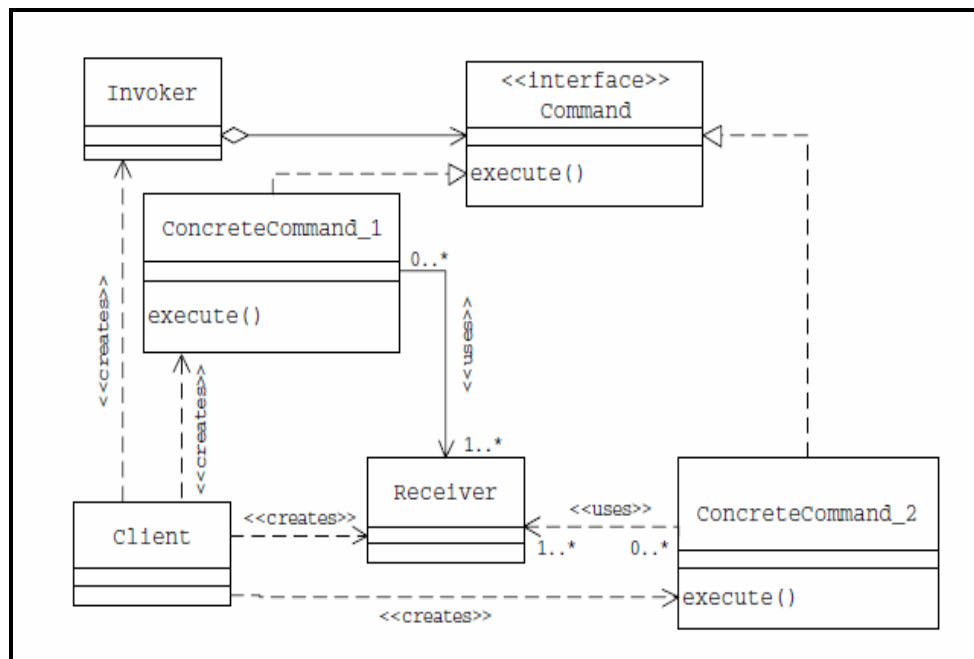

The classes participating in the pattern are:

- i. **Command** - declares an interface for executing an operation.
- ii. **ConcreteCommand** - extends the Command interface, implementing the Execute method by invoking the corresponding operations on Receiver. It defines a link between the Receiver and the action.
- iii. **Client** - creates a ConcreteCommand object and sets its receiver.
- iv. **Invoker** - asks the command to carry out the request.
- v. **Receiver** - knows how to perform the operations.

Flow of Application:

Following are the steps in sequence which are performed to execute an application to implement the command design pattern:

- i. Command object encapsulate a request by binding together a set of actions on a specific receiver by exposing a execute method.
- ii. When execute method is called it causes the actions to be invoked on a receiver
- iii. From outside no other object know which action will be executed against a receiver
- iv. They just know if they will call execute method their request will be served

Advantage and Disadvantages:

Now that we have understood how the pattern works, it's time to take a look at its advantages and flaws, too.

The intelligence of a command:

There are two extremes that a programmer must avoid when using this pattern:

1. The command is just a link between the receiver and the actions that carry out the request.
2. The command implements everything itself, without sending anything to the receiver.

We must always keep in mind the fact that the receiver is the one who knows how to perform the operations needed, the purpose of the command being to help the client to delegate its request quickly and to make sure the command ends up where it should.

Undo and redo actions

As mentioned above, some implementations of the Command design pattern include parts for supporting undo and redo of actions. In order to do that a mechanism to obtain past states of the

Receiver object is needed; in order to achieve this there are two options:

- i. Before running each command a snapshot of the receiver state is stored in memory. This does not require much programming effort but cannot be always applied. For example doing this in an image processing application would require storing images in memory after each step, which is practically impossible.
- ii. Instead of storing receiver objects states, the set of performed operations are stored in memory. In this case the command and receiver classes should implement the inverse algorithms to undo each action. This will require additional programming effort, but less memory will be required. Sometimes for undo/redo actions the command should store more information about the state of the receiver objects. A good idea in such cases is to use the Memento Pattern.

Asynchronous Method Invocation:

Another usage for the command design pattern is to run commands asynchronous in background of an application. In this case the invoker is running in the main thread and sends the requests to the receiver which is running in a separate thread. The invoker will keep a queue of commands to be run and will send them to the receiver while it finishes running them. Instead of using one thread in which the receiver is running more threads can be created for this. But for performance issues (thread creation is consuming) the number of threads should be limited. In this case the invoker will use a pool of receiver threads to run command asynchronously.

Adding new commands

The command object decouples the object that invokes the action from the object that performs the action. There are implementations of the pattern in which the invoker instantiates the concrete command objects. In this case if we need to add a new command type we need to change the invoker as well. And this would violate the Open Close Principle (OCP). In order to have the ability to add new commands with minimum of effort we have to make sure that the invoker is aware only about the abstract command class or interface.

Using composite commands

When adding new commands to the application we can use the composite pattern to group existing commands in another new command. This way, macros can be created from existing commands.

Hot spot

The main advantage of the command design pattern is that it decouples the object that invokes the operation from the one that know how to perform it. And this advantage must be kept. There are implementations of this design pattern in which the invoker is aware of the concrete commands classes. This is wrong making the implementation more tightly coupled. The invoker should be aware only about the abstract command class.

Example:

In stock exchange, the client creates some orders for buying and selling stocks (ConcreteCommands). Then the orders are sent to the agent (Invoker). The agent takes the orders and place them to the StockTrade system (Receiver). The agent keeps an internal queue with the order to be placed. Let's assume that the StockTrade system is closed each Monday, but the agent accepts orders, and queue them to be processed later on.

Proposed Class Diagram:

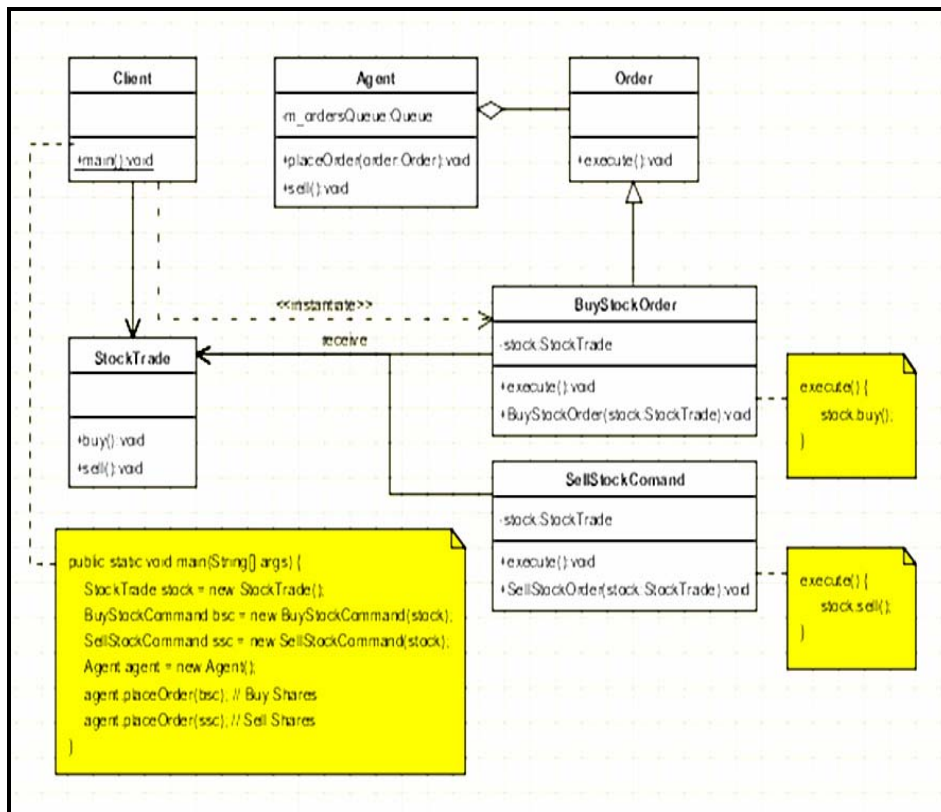

Java Code:**i. OrderInterface Class**

```
public interface Order
{
    public abstract void execute ();
}
```

ii. Reciever Class

```
class StockTrade {
    public void buy() {
        System.out.println("You want to buy stocks");
    }
    public void sell() {
        System.out.println("You want to sell stocks ");
    }
}
```

iii. Invoker Class

```
class Agent {
    private m_ordersQueue = new ArrayList();

    public Agent() {
    }

    void placeOrder(Order order) {
        ordersQueue.addLast(order);
        order.execute(ordersQueue.getFirstAndRemove());
    }
}
```

iv. ConcreteCommand Class

```
v. class BuyStockOrder implements Order {
    private StockTrade stock;
    public BuyStockOrder ( StockTrade st) {
        stock = st;
    }
    public void execute() {
        stock . buy( );
    }
}
```

v. ConcreteCommand Class

```
class SellStockOrder implements Order {
    private StockTrade stock;
    public SellStockOrder ( StockTrade st) {
        stock = st;
    }
    public void execute() {
        stock . sell( );
    }
}
```

vi. Client Class

```
public class Client {
    public static void main(String[] args) {
        StockTrade stock = new StockTrade();
        BuyStockOrder bsc = new BuyStockOrder (stock);
        SellStockOrder ssc = new SellStockOrder (stock);
        Agent agent = new Agent();
        agent.placeOrder(bsc); // Buy Shares
        agent.placeOrder(ssc); // Sell Shares
    }
}
```

LECTURE NO: 44

Objective:

In this lecture we will discuss the Architectural Design patterns as a whole and focusing on “**Model View Controller (MVC)**” design pattern for discussions in detail.

Overview of Architectural Design Patterns:

Architectural patterns express fundamental structural organization schemas for software systems. They provide a set of predefined subsystems, specify their responsibilities, and include rules and guidelines for organizing the relationships between them. These patterns represent the highest-level of patterns in our pattern system. They help you to specify the fundamental structure of an application. Every development activity that follows is governed by this structure—for example, the detailed design of subsystems, the communication and collaboration between different parts of the system, and its later extension.

Each architectural pattern helps you to achieve a specific global system property, such as the adaptability of the user interface. Patterns that help to support similar properties can be grouped into following categories.

- i. Interactive Systems.
- ii. Distributed Systems.
- iii. Broker Systems.

The selection of an architectural pattern should be driven by the general properties of the application at hand. Ask yourself, for example, whether we proposed system is an interactive system, or one that will exist in many slightly different variants. Pattern selection should be further influenced by your application's nonfunctional requirements, such as changeability or reliability.

It is also helpful to explore several alternatives before deciding on a specific architectural pattern. For example, the Presentation-Abstraction-Control pattern (PAC) and the Model-View-Controller pattern (MVC) both lend themselves to interactive applications.

Different architectural patterns imply different consequences, even if they address the same or very similar problems. For example, an MVC architecture is usually more efficient than a PAC

architecture. On the other hand, PAC supports multitasking and task-specific user interfaces better than MVC does.

Most software systems, however, cannot be structured according to a single architectural pattern. They must support several system requirements that can only be addressed by different architectural patterns. For example, you may have to design both for flexibility of component distribution in a heterogeneous computer network and for adaptability of their user interfaces. You must combine several patterns to structure such systems. However, a particular architectural pattern, or a combination of several, is not complete software architecture. It remains a structural framework for a software system that must be further specified and refined. This includes the task of integrating the application's functionality with the framework, and detailing its components and relationships, perhaps with help of design patterns and idioms. The selection of an architectural pattern, or a combination of several, is only the first step when designing the architecture of a software system.

Note:

*In this course we will be discussing “**Interactive System**” only with discussion on “**Model view Controller (MVC)**”.*

Interactive Systems:

Today's systems allow a high degree of user Interaction, mainly achieved with help of graphical user Interfaces. The objective is to enhance the usability of an application. Usable software systems provide convenient access to their services, and therefore allow users to learn the application and produce results quickly.

When specifying the architecture of such systems, the challenge is to keep the functional core independent of the user interface. The core of Interactive systems is based on the functional requirements for the system, and usually remains stable. User Interfaces, however, are often subject to change and adaptation. For example, systems may have to support different user interface standards, customer-specific 'look and feel' metaphors, or interfaces that must be adjusted to fit into a customer's business processes. This requires architectures that support the adaptation of user Interface parts without causing major effects to application-specific functionality or the data model underlying the software.

We describe two patterns that provide a fundamental structural organization for interactive software systems:

- i. The **Model-View-Controller pattern (MVC)** divides an Interactive application into three components. The model contains the core functionality and data. Views display information to the user. Controllers handle user input. Views and controllers together comprise the user interface. A change-propagation mechanism ensures consistency between the user Interface and the model.

- ii. The **Presentation-Abstraction-Control pattern (PAC)** defines a structure for Interactive software systems in the form of a hierarchy of cooperating agents. Every agent is responsible for a specific aspect of the application's functionality and consists of three components: presentation, abstraction, and control. This subdivision separates the human-computer Interaction aspects of the agent from its functional core and its communication with other agents.

PAC is not used as widely as MVC, but as an alternative approach for structuring interactive applications, PAC is especially applicable to systems that consist of several self-reliant subsystems. PAC also addresses issues that MVC leaves unresolved, such as how to effectively organize the communication between different parts of the functional core and the user interface. PAC was first described by Joelle Coutaz. The first application of PAC was in the area of Artificial Intelligence.

Model – View – Controller (MVC):

The Model-View-Controller architectural pattern (MVC) divides an interactive application into three components. The model contains the core functionality and data. Views display information to the user. Controllers handle user input. Views and controllers together comprise the user interface. A change-propagation mechanism ensures consistency between the user interface and the model.

Consider a simple information system for political elections with proportional representation. This offers a spreadsheet for entering data and several kinds of tables and charts for presenting the current results. Users can interact with the system via a graphical interface. All information displays must reflect changes to the voting data immediately.

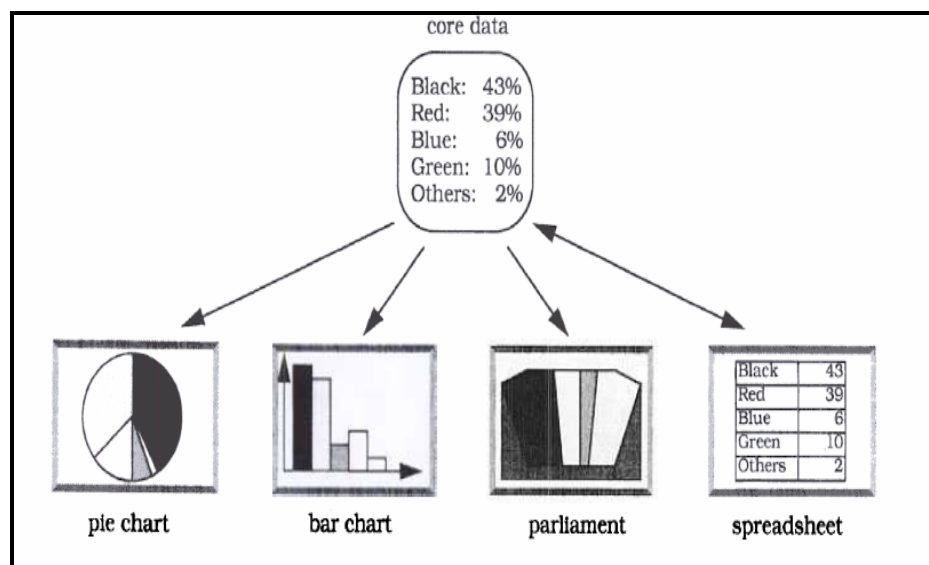

It should be possible to integrate new ways of data presentation such as the assignment of parliamentary seats to political parties without major impact to the system. The system should also be **portable** to platforms with different “**look and feel**”.

Context of the Problem:

- We need to have an interactive application with a flexible human-computer interface.
- It should be possible to represent one Data with multiple possible representations.

Problem

User interfaces are especially prone to change requests. When you extend the functionality of an application, you must modify menus to access these new functions. A customer may call for a specific user interface adaptation, or a system may need to be ported to another platform with a different 'look and feel' standard. Even upgrading to a new release of window system can imply code changes. The user interface platform of long-lived systems thus represents a moving target. Different users place conflicting requirements on the user interface. A typist enters information into forms via the keyboard. A manager wants to use the same system mainly by clicking icons and buttons. Consequently support for several user interface paradigms should be easily incorporated. Building a system with the required flexibility is expensive and error prone if the user interface is tightly interwoven with the functional core. This can result in the need to develop and maintain several substantially different software systems one for each user interface implementation. Ensuing changes spread over many modules.

The following forces influence the solution:

- i. The same information is presented differently in different windows, for example, in a bar or pie chart.
- ii. The display and behavior of the application must reflect data manipulations immediately. Changes to the user interface should be easy and even possible at run-time.
- iii. Supporting different 'look and feel' standards or porting the user interface should not affect code in the core of the application.

Solution:

Basic parts of any application include the following processing steps:

- i. Data being manipulated
- ii. A user-interface through which this manipulation occurs
- iii. The data is logically independent from how it is displayed to the user, display should be separately designable/evolvable

Model-View-Controller (MVC) was first introduced in the Smalltalk-80 programming environment [KP88]. MVC divides an interactive application into the three areas: processing, output, and input.

The model component encapsulates **core data and functionality**. The **model** is independent of specific output representations or input behavior. **View** components display information to the user. A view obtains the data from the model. There can be multiple views of the model. Each view has an associated **controller** component. Controllers receive input, usually as events that encode mouse movement, activation of mouse buttons, or keyboard input. Events are translated to service requests for the model or the view. The user interacts with the system solely through controllers. The separation of the model from view and controller components allows multiple views of the same model. If the user changes the model via the controller of one view, all other views dependent on this data should reflect the changes. The model therefore notifies all views whenever its data changes. The views in turn retrieve new data from the model and update the displayed information.

The model component contains the functional core of the application. It encapsulates the appropriate data, and exports procedures that perform application-specific processing. Controllers call these procedures on behalf of the user. The model also provides functions to access its data that are used by view components to acquire the data to be displayed.

The change-propagation mechanism maintains a registry of the dependent components within the model. All views and also selected controllers register their need to be informed about changes. Changes to the state of the model trigger the change-propagation mechanism. The change-propagation mechanism is the only link between the model and the views and controllers.

View components present information to the user. Different views present the information of the model in different ways. Each view defines an update procedure that is activated by the change propagation mechanism. When the update procedure is called, a view retrieves the current data values to be displayed from the model and puts them on the screen.

During initialization all views are associated with the model, and register with the change-propagation mechanism. Each view creates a suitable controller. There is a one-to-one relationship between views and controllers. Views often offer functionality that allows controllers to manipulate the display. This is useful for user-triggered operations that do not affect the model, such as scrolling. The controller components accept user input as events. How these events are delivered to a controller depends on the user interface platform. For simplicity let us assume that each controller implements an event-handling procedure that is called for each relevant event. Events are translated into requests for the model or the associated view. If the behavior of a controller depends on the state of the model, the controller registers itself with the change-propagation mechanism and implements an update procedure. For example this is necessary when a change to the model enables or disables a menu entry.

Graphical Representations of MVC

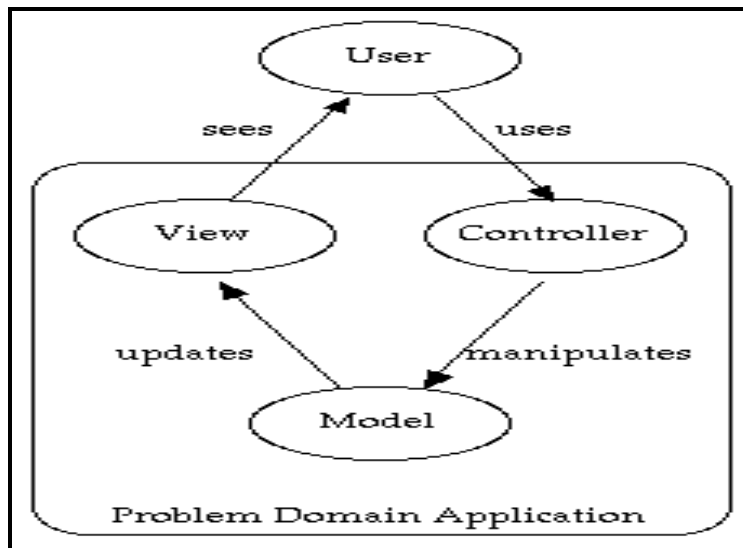

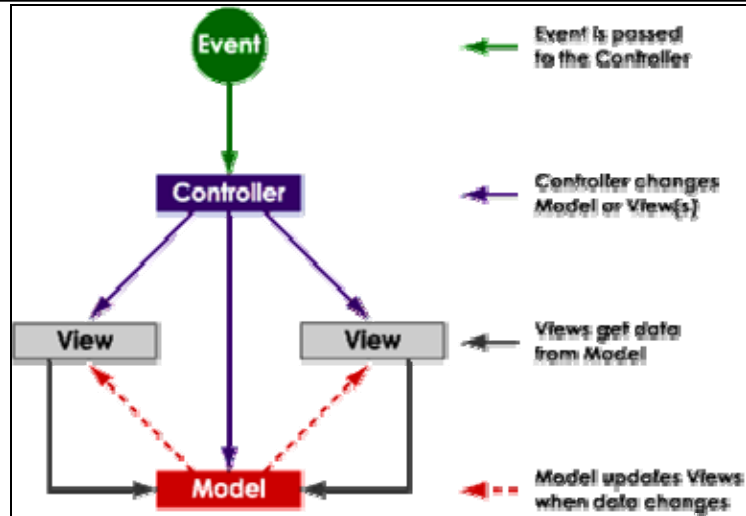

Mapping of MVC with Java:

- i. View is a Swing widget (like a JButton etc)
- ii. Controller is an ActionListener (Event Handler) including business logic
- iii. Model is an ordinary Java class (or database)

Alternate Mapping of MVC to Java:

- i. View is a Swing widget and includes (inner) ActionListener(s) as event handlers
- ii. Controller is an ordinary Java class with “**business logic**”, invoked by event handlers in view
- iii. Model is an ordinary Java class (or database)

Example of using MVC:

We need to design a program (GUI) based in which we need to multiply a particular value by a initial value and then each subsequent value should be multiply by the result of the previous multiplication and this process will continue we close down the application. It should be kept in mind that initial value is to be replaced with updated multiplied value of the previous calculation so that it will become initial value for the next calculation.

Step-wise Processing of the Solution

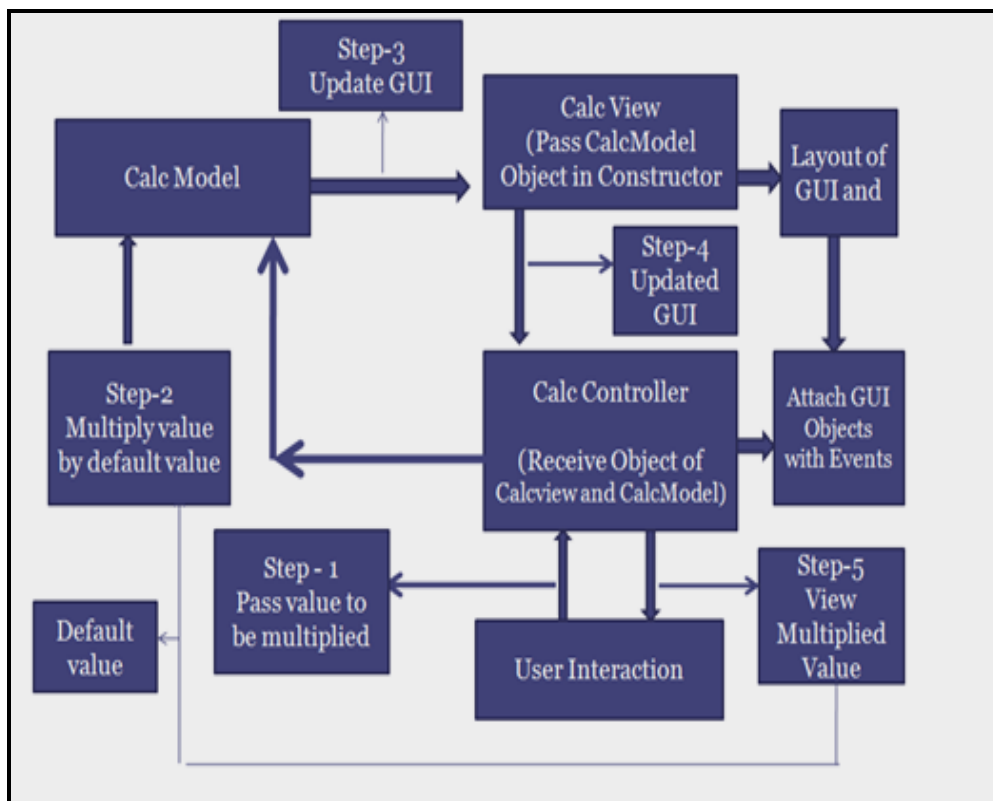

Java Code:

i. View Class:

This View doesn't know about the Controller, except that it provides methods for registering a Controller's listeners. Other organizations are possible (e. g, the Controller's listeners are non-private variables that can be referenced by the View, the View calls the Controller to get listeners, the View calls methods in the Controller to process actions)

```
import java.awt.*;
import javax.swing.*;
import java.awt.event.*;

class CalcView extends JFrame {
    //... Constants
    private static final String INITIAL_VALUE = "1";

    //... Components
    private JTextField m_userInputTf = new JTextField(5);
    private JTextField m_totalTf    = new JTextField(20);
    private JButton    m_multiplyBtn = new JButton("Multiply");
    private JButton    m_clearBtn    = new JButton("Clear");

    private CalcModel m_model;

    CalcView(CalcModel model) {
        //... Set up the logic
        m_model = model;
        m_model.setValue(INITIAL_VALUE);

        //... Initialize components
        m_totalTf.setText(m_model.getValue());
        m_totalTf.setEditable(false);

        //... Layout the components.
```

```
JPanel content = new JPanel();
content.setLayout(new FlowLayout());
content.add(new JLabel("Input"));
content.add(m_userInputTf);
content.add(m_multiplyBtn);
content.add(new JLabel("Total"));
content.add(m_totalTf);
content.add(m_clearBtn);

//... finalize layout
this.setContentPane(content);
this.pack();

this.setTitle("Simple Calc - MVC");
// The window closing event should probably be passed to the
// Controller in a real program, but this is a short example.
this.setDefaultCloseOperation(JFrame.EXIT_ON_CLOSE);
}

void reset() {
    m_totalTf.setText(INITIAL_VALUE);
}

String getUserInput() {
    return m_userInputTf.getText();
}

void setTotal(String newTotal) {
    m_totalTf.setText(newTotal);
}

void showError(String errMessage) {
    JOptionPane.showMessageDialog(this, errMessage);
}

void addMultiplyListener(ActionListener mal) {
    m_multiplyBtn.addActionListener(mal);
}
```

```
}  
  
void addClearListener(ActionListener cal) {  
    m_clearBtn.addActionListener(cal);  
}  
}
```

ii. Controller Class

The controller processes the user requests. It is implemented here as an **Observer pattern** -- the Controller registers listeners that are called when the View detects a user interaction. Based on the user request, the Controller calls methods in the View and Model to accomplish the requested action.

```
import java.awt.event.*;  
  
public class CalcController {  
    //... The Controller needs to interact with both the Model and View.  
    private CalcModel m_model;  
    private CalcView m_view;  
  
    /** Constructor */  
    CalcController(CalcModel model, CalcView view) {  
        m_model = model;  
        m_view = view;  
  
        //... Add listeners to the view.  
        view.addMultiplyListener(new MultiplyListener());  
        view.addClearListener(new ClearListener());  
    }  
  
    // inner class MultiplyListener  
    /** When a multiplication is requested.  
     * 1. Get the user input number from the View.  
     * 2. Call the model to multiply by this number.  
     * 3. Get the result from the Model.  
     * 4. Tell the View to display the result.     */  
}
```

```
* If there was an error, tell the View to display it.
*/

class MultiplyListener implements ActionListener {
    public void actionPerformed(ActionEvent e) {
        String userInput = "";
        try {
            userInput = m_view.getUserInput();
            m_model.multiplyBy(userInput);
            m_view.setTotal(m_model.getValue());

        } catch (NumberFormatException nfex) {
            m_view.showError("Bad input: " + userInput + "");
        }
    }
}

} //end inner class MultiplyListener

// inner class ClearListener
/** 1. Reset model.
 * 2. Reset View.
 */
class ClearListener implements ActionListener {
    public void actionPerformed(ActionEvent e) {
        m_model.reset();
        m_view.reset();
    }
}

} // end inner class ClearListener
}
```

iii. Model Class

The model is independent of the user interface. It doesn't know if it's being used from a text-based, graphical, or web interface. This is the same model used in the presentation example.

```
import java.math.BigInteger;

public class CalcModel {
    //... Constants
    private static final String INITIAL_VALUE = "0";
    //... Member variable defining state of calculator.
    private BigInteger m_total; // The total current value state.

    /** Constructor */
    CalcModel() {
        reset();
    }
    /** Reset to initial value. */
    public void reset() {
        m_total = new BigInteger(INITIAL_VALUE);
    }

    /** Multiply current total by a number.
    *@param operand Number (as string) to multiply total by.
    */
    public void multiplyBy(String operand) {
        m_total = m_total.multiply(new BigInteger(operand));
    }
    /** Set the total value.
    *@param value New value that should be used for the calculator total.
    */
    public void setValue(String value) {
        m_total = new BigInteger(value);
    }
    /** Return current calculator total. */
    public String getValue() {
```

```
return m_total.toString(); }}
```

iv. Main Class

```
import javax.swing.*;
```

```
public class CalcMVC {
```

```
    //... Create model, view, and controller. They are
```

```
    // created once here and passed to the parts that
```

```
    // need them so there is only one copy of each.
```

```
    public static void main(String[] args)
```

```
{
```

```
    CalcModel    model    = new CalcModel();
```

```
    CalcView     view     = new CalcView(model);
```

```
    CalcController controller = new CalcController(model, view);
```

```
    view.setVisible(true);
```

```
}}
```

LECTURE NO: 45

Objective:

In the last lecture we will have a discussion on **refactoring** followed by discussion on “**Anti-Patterns**”. “**Anti-Patterns**” will be discussed along with its categories.

What is Refactoring:

Refactoring is a disciplined technique for restructuring an existing body of code, altering its internal structure without changing its external behavior. Its heart is a series of small behavior preserving transformations. Each transformation (called a 'refactoring') does little, but a sequence of transformations can produce a significant restructuring. I don't want to proclaim refactoring as the cure for all software ills. It is no “**silver bullet.**” Yet it is a valuable tool, a pair of silver pliers that helps you keep a good grip on your code. Refactoring is a tool that can, and should, be used for several purposes. Without refactoring, the design of the program will decay. As people change code—changes to realize short-term goals or changes made without a full comprehension of the design of the code—the code loses its structure. It becomes harder to see the design by reading the code. Refactoring is rather like tidying up the code. Work is done to remove bits that aren't really in the right place. Loss of the structure of code has a cumulative effect. The harder it is to see the design in the code, the harder it is to preserve it, and the more rapidly it decays. Regular refactoring helps code retain its shape. Poorly designed code usually takes more code to do the same things, often because the code quite literally does the same thing in several places. Thus an important aspect of improving design is to eliminate duplicate code. The importance of this lies in future modifications to the code. Reducing the amount of code won't make the system run any faster, because the effect on the footprint of the programs rarely is significant. Reducing the amount of code does, however, make a big difference in modification of the code. The more code there is, the harder it is to modify correctly. There's more code to understand. You change this bit of code here, but the system doesn't do what you expect because you didn't change that bit over there that does much the same thing in a slightly different context. By eliminating the duplicates, you ensure that the code says everything once and only once, which is the essence of good design. Programming is in many ways a conversation with a computer. You write code that tells the computer what to do, and it responds by doing exactly what you tell it. In time you close the gap between what you want it to do and what you tell it to do. Programming in this mode is all about

saying exactly what you want. But there is another user of your source code. Someone will try to read your code in a few months' time to make some changes. We easily forget that extra user of the code, yet that user is actually the most important. Who cares if the computer takes a few more cycles to compile something? It does matter if it takes a programmer a week to make a change that would have taken only an hour if she had understood your code. The trouble is that when you are trying to get the program to work, you are not thinking about that future developer. It takes a change of rhythm to make changes that make the code easier to understand. Refactoring helps you to make your code more readable. When refactoring you have code that works but is not ideally structured. A little time spent refactoring can make the code better communicate its purpose. Programming in this mode is all about saying exactly what you mean. Often this future developer is me. Here refactoring is particularly important. I'm a very lazy programmer. One of my forms of laziness is that I never remember things about the code I write. Indeed, I deliberately try not remember anything I can look up, because I'm afraid my brain will get full. I make a point of trying to put everything I should remember into the code so I don't have to remember it. This understandability works another way, too. I use refactoring to help me understand unfamiliar code. When I look at unfamiliar code, I have to try to understand what it does. I look at a couple of lines and say to myself, oh yes, that's what this bit of code is doing. With refactoring I don't stop at the mental note. I actually change the code to better reflect my understanding, and then I test that understanding by rerunning the code to see if it still works. Early on I do refactoring like this on little details. As the code gets clearer, I find I can see things about the design that I could not see before. Had I not changed the code, I probably never would have seen these things, because I'm just not clever enough to visualize all this in my head. Ralph Johnson describes these early refactoring as wiping the dirt off a window so you can see beyond. When I'm studying code I find refactoring leads me to higher levels of understanding that otherwise I would miss. **Smells (especially code smells)** are warning signs about potential problems in code. Not all smells indicate a problem, but most are worthy of a look and a decision. Smells usually describe localized problems. It would be nice if people could find problems easily across a whole system. But humans aren't so good at that job; local smells work with our tendency to consider only the part we're looking at right now.

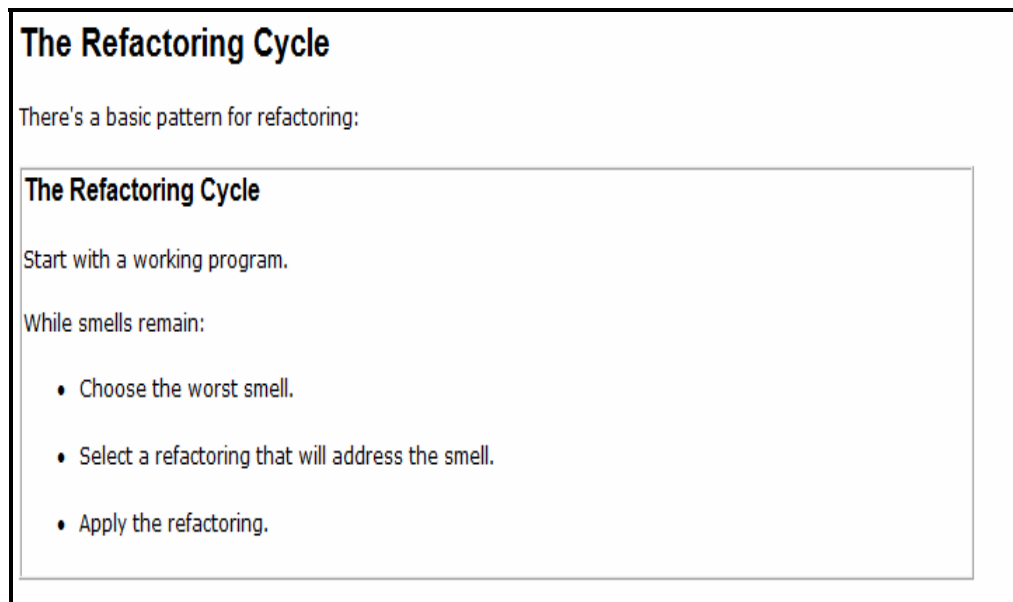

Measured Smells

- i. They're dead easy to detect.
- ii. They're objective (once you decide on a way to count and a maximum acceptable score).
They're horrible. And, they're common.
- iii. We can think of these smells as being caught by software metric. Each metric tends to catch different aspects of why code isn't as good as it could be.

Applying Refactoring:

We try to select refactoring that improves the code in each trip through the cycle. Because none of the steps change the program's observable behavior, the program remains in a working state. Thus, the cycle improves code but retains behavior. The trickiest part of the whole process is identifying the smell, here it would be worth mentioning that it may happen that multiple cycles yields no optimization in the existing code because it is not a rule that applying certain process will improve the code but it good practice to look for improvement.

What are Anti-Patterns:

Software systems are becoming increasingly more complex, which makes it hard to properly design and implement them. A study has shown that on average five out of six software projects fail. They suffer from either cost overruns, time overruns or are cancelled altogether. The reasons for such failures are manifold, but one can observe that the same mistakes are repeated again and again. This is even the case in situations where proven and working solutions exist. *Design Patterns*, solutions to recurring problems, explain "best practices" in software development. They provide knowledge that can easily be reused in different types of software; however, even Design Patterns – used in the wrong context or applied inappropriately – can have negative consequences.

Jim Coplien:

“Something that looks like a good idea, but which backfires badly when applied”

The term was coined in **1995** by **Andrew Koenig**, inspired by Gang of Four's book *Design Patterns*, which developed the concept of design patterns in the software field. The term was widely popularized three years later by the book *AntiPatterns*, which extended the use of the term beyond the field of software design and into general social interaction.

These are the application of such a pattern that may be commonly used but is ineffective and/or counterproductive in practice for that particular scenario. The AntiPattern may be the result of a manager or developer not knowing any better, not having sufficient knowledge or experience in solving a particular type of problem, or having applied a perfectly good pattern in the wrong context.

AntiPatterns are useful in several ways:

- i. They provide a common vocabulary for known dysfunctional software designs and solutions, as every AntiPattern has a short and descriptive name like *Gold Class etc.*
- ii. They help detecting problems in the code, the architecture and the management of software projects.
- iii. They describe both, preventive measures as well as *refactored solutions*, which can save software projects in trouble.

Famous Anti-Patterns:

Some of the commonly known anti-patterns are as below, however it should be noted that there exists many anti-pattern and it is possible that you may never face any anti-pattern in your lifetime.

- i. Patterns Fetish or Pattern Craze
- ii. The Swiss-Army Knife
- iii. The Crystal Ball
- iv. The God Class
- v. Abstraction inversion

i. Patterns Fetish or Pattern Craze

This pattern truly depicts that fact that everything one knows is not always true for application; this anti-pattern refers to Unreasonable and excessive use of design patterns. Software Designer looks for places to use patterns because of the knowledge of the design pattern it is forced to get applied irrespective of the fact it is needed or not i-e **“Right thing wrong place”**.

Suppose we want to print hello world it might happen that we can apply **Abstract Factory pattern** for this simple task as shown below:

```
public class HelloWorld {  
    public static void main(String[] args) {  
        MessageBody mb = new MessageBody();  
        mb.configure("Hello World!");  
        AbstractStrategyFactory asf = DefaultFactory.getInstance();  
        MessageStrategy strategy = asf.createStrategy(mb);  
        mb.send(strategy);  
    }  
}
```

```
public class DefaultFactory extends AbstractStrategyFactory {
    private DefaultFactory() {}
    static DefaultFactory instance;
    public static AbstractStrategyFactory getInstance() {
        if (instance==null) instance = new DefaultFactory();
        return instance;
    }

    public MessageStrategy createStrategy(final MessageBody mb) {
        return new MessageStrategy() {
            MessageBody body = mb;
            public void sendMessage() {
                Object obj =|body.getPayload();
                System.out.println((String)obj);
            }
        };
    }
}
```

Instead of this heavy weight code to perform the simple task we can write very simple and less code as shown below:

```
public class HelloWorld {
    public static void main(String[ ] args) {
        System.out.println("Hello, world!");
    }
}
```

ii. Swiss Army Knife

- This is the scenario where for using applying polymorphism, we have more interfaces than classes. The number of interfaces on a class produces a severe case of instability. A **Basic Litmus-Test for the Swiss Army Knife** anti-pattern is by asking this simple question:
 - ✓ Do your classes implement more than 3 interfaces?
 - ✓ If yes than it is going to be an issue in term of software maintenance.

Look at the code below in the box:

```
public class ScheduleItemDisplay Implements
  MessageListener, ErrorListener, HelpRequestListener,
  OpenScheduleListener, AttributeBigListListener,
  OKListener, DeleteScheduleListener,
  RefreshScheduleListListener,
  ScheduleWeekChangeListener, NetworkChangeListener,
  ScheduleItemListener, LayoutChangedListener,
  ItemListener, ScheduleChangeValidator,
  InternalFrameListener, RenameScheduleListener,
  CancelListener, MirrorPolicyControlListener
{
}
```

The syntax is ok but semantically we have written a code which will be nightmare for us because intentionally or un-intentionally we have written a class which is implementing obviously many more than 3 interfaces which pass our litmus test for “**Swiss Army Knife**”. What need to understand is:

- i. More != Better
- ii. Too many interfaces creates confusion
- iii. Maintenance problems
- iv. Each interface requires implementation of items on that interface
- v. Do your classes actually need to share an interface?

Solutions:

It might happen that our class needs to USE another class **Aggregation, Composition** or “**Façade**” design pattern because it **selects** inner objects to do the work rather than interfaces.

iii. The Crystal Ball

This scenario reflect non-availability of future requirements or we are designing for the unknown or future potentials where there is little to no justification. It is true that we do assumptions while we are designing but there are no un-scoped assumptions or we can say that there are no assumptions about the assumptions because it we assume too much than design reaches out too far and assumes too much. The Base classes are overly generic for the problem domain and they implement methods/attributes that add little value sub-classes have little in common with their Siblings and we adding new subclasses because we have no justification for them i-e we think that we are doing inheritance but in-fact we are not doing inheritance.

Sesame Street Rule:

“One of these things is not like the other”

Example:

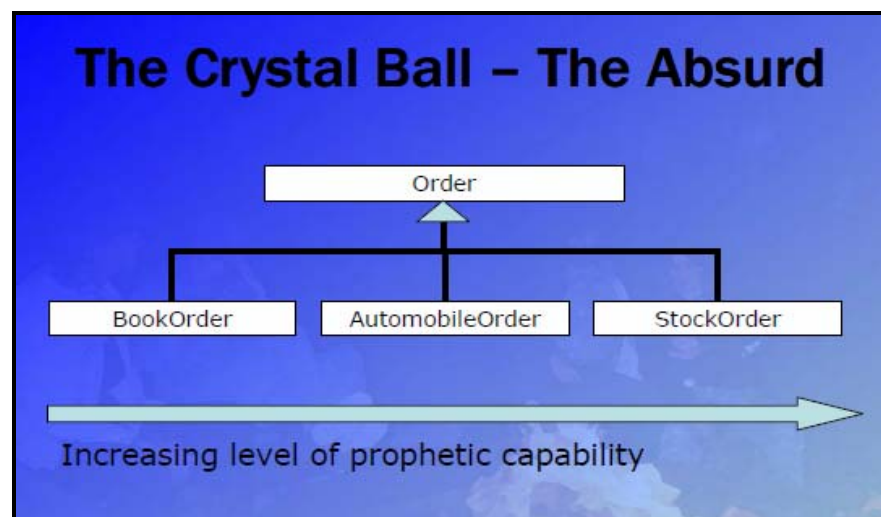

iv. The God Class

This is a scenario where we are trying to write all the possibilities of the problem in one class and in search for simplicity we indirectly invite complexity. The logo of this anti-pattern is:

One “Do It All” class

This logo implicitly means that we ignore design rules for optimization i.e. inheritance, polymorphism, abstract classes and others because we are trying to write a class which will solve our all the problem.

Symptoms

- i. Major tip-off = an excessive number of methods
- ii. Lack of specialization, low cohesion
- iii. One class manages all behaviors for what probably should be “**logical subtypes**”

The code below in the box shows that for every type of customer we are writing some code without taking into consideration their commonalities so that we can have a further optimized version of our code.

```
public void DoSomething( )
{
    switch( _customerType)
    {
        case (CustType.Gold)
            // do something for "gold" customers
            break;
        case (CustType.Silver)
            // do something for "silver" customers
            break;
        case (CustType.Bronze)
            // do something for "bronze" customers
            break;
    }
}
```

A better version of the same code is as below:

```
public abstract class customer
{
    public abstract void dosomething();
}

public class customerGold extends customer
{
    public dosomething()
    {
        //provide Gold customer specific implementation.
    }
}}
```

v. Abstraction Inversion

This anti-pattern comes up with a design when users of a construct need functions implemented within it but not exposed by its interface. The result is that the users re-implement the required functions in terms of the interface, which in its turn uses the internal implementation of the same functions. This means that essential methods are missing which are required by the user, this scenario we called “**Missing requirement**” problem. The user of such a re-implemented function may seriously underestimate its running-costs. The user of the construct is forced to doubt his implementation with complex mechanical details. Many users attempt to solve the same problem, increasing the risk of error and give rise to non-standard version of the method i-e each user will have its own implementation which will ultimately generate inconsistent design component.